

500MHz Low Power Current Feedback Amplifiers with Enable

The EL5162, EL5163, EL5262, EL5263, and EL5362 are current feedback amplifiers with a bandwidth of 500MHz. This makes these amplifiers ideal for today's high speed video and monitor applications.

With a supply current of just 1.5mA and the ability to run from a single supply voltage from 5V to 12V, these amplifiers are also ideal for handheld, portable or battery-powered equipment.

The EL5162 also incorporates an enable and disable function to reduce the supply current to 100 μ A typical per amplifier. Allowing the CE pin to float or applying a low logic level will enable the amplifier.

The EL5162 is available in 6-pin SOT-23 and 8-pin SO packages, the EL5163 in 5-pin SOT-23 and SC-70 packages, the EL5262 in the 10-pin MSOP package, the EL5263 in 8-pin MSOP and SO packages, and the EL5362 in 16-pin SO (0.150") and QSOP packages. All operate over the industrial temperature range of -40°C to +85°C.

Features

- 500MHz -3dB bandwidth
- 4000V/ μ s slew rate
- 1.5mA supply current
- Single and dual supply operation, from 5V to 12V supply span
- Fast enable/disable (EL5162, EL5262 & EL5362 only)
- Available in SOT-23 packages
- Pb-Free plus anneal available (RoHS compliant)
- High speed, 1.4GHz product available (EL5167 & EL5167)
- High speed, 4mA, 630MHz product available (EL5164 & EL5165)

Applications

- Battery-powered equipment
- Handheld, portable devices
- Video amplifiers
- Cable drivers
- RGB amplifiers
- Test equipment
- Instrumentation
- Current to voltage converters

Ordering Information

PART NUMBER	PACKAGE	TAPE & REEL	PKG. DWG. #
EL5162IS	8-Pin SO	-	MDP0027
EL5162IS-T7	8-Pin SO	7"	MDP0027
EL5162IS-T13	8-Pin SO	13"	MDP0027
EL5162ISZ (See Note)	8-Pin SO (Pb-Free)	-	MDP0027
EL5162ISZ-T7 (See Note)	8-Pin SO (Pb-Free)	7"	MDP0027
EL5162ISZ-T13 (See Note)	8-Pin SO (Pb-Free)	13"	MDP0027
EL5162IW-T7	6-Pin SOT-23	7" (3K pcs)	MDP0038
EL5162IW-T7A	6-Pin SOT-23	7" (250 pcs)	MDP0038
EL5162IWZ-T7 (See Note)	6-Pin SOT-23 (Pb-Free)	7" (3K pcs)	MDP0038
EL5162IWZ-T7A (See Note)	6-Pin SOT-23 (Pb-Free)	7" (250 pcs)	MDP0038
EL5163IW-T7	5-Pin SOT-23	7" (3K pcs)	MDP0038
EL5163IW-T7A	5-Pin SOT-23	7" (250 pcs)	MDP0038
EL5163IWZ-T7 (See Note)	5-Pin SOT-23 (Pb-Free)	7" (3K pcs)	MDP0038
EL5163IWZ-T7A (See Note)	5-Pin SOT-23 (Pb-Free)	7" (250 pcs)	MDP0038
EL5163IC-T7	5-Pin SC-70	7" (3K pcs)	P5.049
EL5163IC-T7A	5-Pin SC-70	7" (250 pcs)	P5.049
EL5163ICZ-T7 (See Note)	5-Pin SC-70 (Pb-Free)	7" (3K pcs)	P5.049
EL5163ICZ-T7A (See Note)	5-Pin SC-70 (Pb-Free)	7" (250 pcs)	P5.049
EL5262IY	10-Pin MSOP	-	MDP0043
EL5262IY-T7	10-Pin MSOP	7"	MDP0043
EL5262IY-T13	10-Pin MSOP	13"	MDP0043
EL5262IYZ (See Note)	10-Pin MSOP (Pb-Free)	-	MDP0043
EL5262IYZ-T7 (See Note)	10-Pin MSOP (Pb-Free)	7"	MDP0043
EL5262IYZ-T13 (See Note)	10-Pin MSOP (Pb-Free)	13"	MDP0043
EL5263IS	8-Pin SO	-	MDP0027
EL5263IS-T7	8-Pin SO	7"	MDP0027
EL5263IS-T13	8-Pin SO	13"	MDP0027
EL5263ISZ (See Note)	8-Pin SO (Pb-Free)	-	MDP0027
EL5263ISZ-T7 (See Note)	8-Pin SO (Pb-Free)	7"	MDP0027

Ordering Information (Continued)

PART NUMBER	PACKAGE	TAPE & REEL	PKG. DWG. #
EL5263ISZ-T13 (See Note)	8-Pin SO (Pb-Free)	13"	MDP0027
EL5263IY	8-Pin MSOP	-	MDP0043
EL5263IY-T7	8-Pin MSOP	7"	MDP0043
EL5263IY-T13	8-Pin MSOP	13"	MDP0043
EL5362IS	16-Pin SO (0.150")	-	MDP0027
EL5362IS-T7	16-Pin SO (0.150")	7"	MDP0027
EL5362IS-T13	16-Pin SO (0.150")	13"	MDP0027
EL5362ISZ (See Note)	16-Pin SO (0.150") (Pb-Free)	-	MDP0027
EL5362ISZ-T7 (See Note)	16-Pin SO (0.150") (Pb-Free)	7"	MDP0027
EL5362ISZ-T13 (See Note)	16-Pin SO (0.150") (Pb-Free)	13"	MDP0027
EL5362IU	16-Pin QSOP	-	MDP0040
EL5362IU-T7	16-Pin QSOP	7"	MDP0040
EL5362IU-T13	16-Pin QSOP	13"	MDP0040
EL5362IUZ (See Note)	16-Pin QSOP (Pb-Free)	-	MDP0040
EL5362IUZ-T7 (See Note)	16-Pin QSOP (Pb-Free)	7"	MDP0040
EL5362IUZ-T13 (See Note)	16-Pin QSOP (Pb-Free)	13"	MDP0040

NOTE: Intersil Pb-free plus anneal products employ special Pb-free material sets; molding compounds/die attach materials and 100% matte tin plate termination finish, which are RoHS compliant and compatible with both SnPb and Pb-free soldering operations. Intersil Pb-free products are MSL classified at Pb-free peak reflow temperatures that meet or exceed the Pb-free requirements of IPC/JEDEC J STD-020.

Pinouts

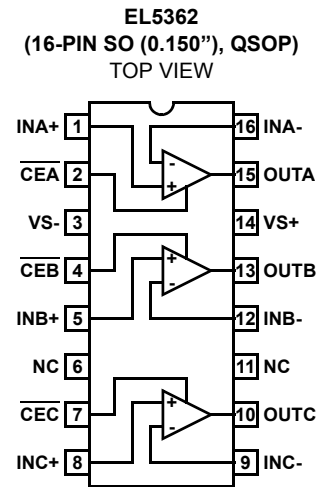
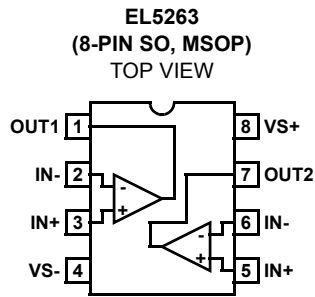
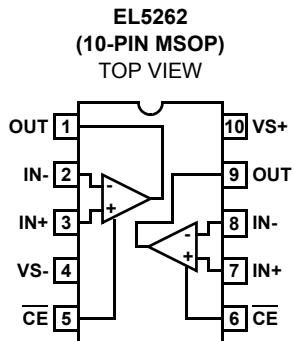
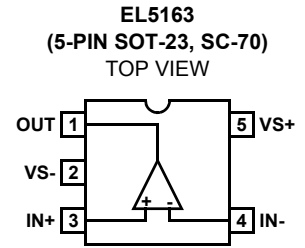
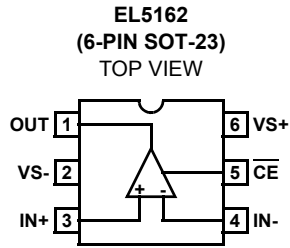
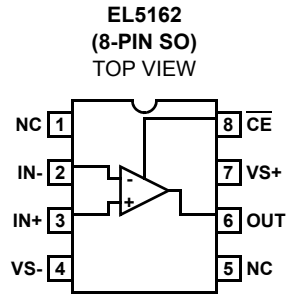

EL5162, EL5163, EL5262, EL5263, EL5362

Absolute Maximum Ratings (T_A = 25°C)

Supply Voltage between V _{S+} and V _{S-} 13.2V	Maximum Voltage between IN+ and IN-, disabled. ±1.5V
Maximum Continuous Output Current 50mA	Current into IN+, IN-, CE ±5mA
Operating Junction Temperature 125°C	Pin Voltages. V _{S-} - 0.5V to V _{S+} + 0.5V
Power Dissipation See Curves	Storage Temperature -65°C to +150°C
Slewrate of V _{S+} to V _{S-} 1V/μs	Ambient Operating Temperature -40°C to +85°C

CAUTION: Stresses above those listed in "Absolute Maximum Ratings" may cause permanent damage to the device. This is a stress only rating and operation of the device at these or any other conditions above those indicated in the operational sections of this specification is not implied.

IMPORTANT NOTE: All parameters having Min/Max specifications are guaranteed. Typical values are for information purposes only. Unless otherwise noted, all tests are at the specified temperature and are pulsed tests, therefore: T_J = T_C = T_A

Electrical Specifications V_{S+} = +5V, V_{S-} = -5V, R_F = 750Ω for A_V = 1, R_F = 400Ω for A_V = 2, R_L = 150Ω, T_A = 25°C unless otherwise specified.

PARAMETER	DESCRIPTION	CONDITIONS	MIN	TYP	MAX	UNIT
AC PERFORMANCE						
BW	-3dB Bandwidth	A _V = +1, R _L = 500Ω, R _F = 598Ω		500		MHz
		A _V = +2, R _L = 150Ω, R _F = 422Ω		233		MHz
BW1	0.1dB Bandwidth			30		MHz
SR	Slew Rate	V _O = -2.5V to +2.5V, A _V = +2, R _L = 100Ω (EL5262, EL5263, EL5362)	2000	2500	4000	V/μs
		V _O = -2.5V to +2.5V, A _V = +2, R _L = 100Ω (EL5162, EL5163)	2800	4000	6000	V/μs
t _S	0.1% Settling Time	V _{OUT} = -2.5V to +2.5V, A _V = +1		25		ns
e _N	Input Voltage Noise			3		nV/√Hz
i _{N-}	IN- Input Current Noise			10		pA/√Hz
i _{N+}	IN+ Input Current Noise			6.5		pA/√Hz
dG	Differential Gain Error (Note 1)	A _V = +2		0.05		%
dP	Differential Phase Error (Note 1)	A _V = +2		0.15		°
DC PERFORMANCE						
V _{OS}	Offset Voltage		-5	1.5	+5	mV
T _C V _{OS}	Input Offset Voltage Temperature Coefficient	Measured from T _{MIN} to T _{MAX}		6		μV/°C
R _{OL}	Transimpedance		500	1000		kΩ
INPUT CHARACTERISTICS						
CMIR	Common Mode Input Range	Guaranteed by CMRR test	±3	±3.3		V
CMRR	Common Mode Rejection Ratio	V _{IN} = ±3V	50	62	75	dB
-ICMR	- Input Current Common Mode Rejection		-1	0.22	+1	μA/V
+I _{IN}	+ Input Current		-8	0.5	+8	μA
-I _{IN}	- Input Current		-10	2	+10	μA
R _{IN}	Input Resistance		0.8	1.6	3	MΩ
C _{IN}	Input Capacitance			1		pF
OUTPUT CHARACTERISTICS						
V _O	Output Voltage Swing	R _L = 150Ω to GND	±3.35	±3.6	±3.75	V
		R _L = 1kΩ to GND	±3.75	±3.9	±4.15	V
I _{OUT}	Output Current	R _L = 10Ω to GND	60	100		mA

EL5162, EL5163, EL5262, EL5263, EL5362

Electrical Specifications $V_{S+} = +5V$, $V_{S-} = -5V$, $R_F = 750\Omega$ for $A_V = 1$, $R_F = 400\Omega$ for $A_V = 2$, $R_L = 150\Omega$, $T_A = 25^\circ C$ unless otherwise specified. **(Continued)**

PARAMETER	DESCRIPTION	CONDITIONS	MIN	TYP	MAX	UNIT
SUPPLY						
I_{SON}	Supply Current - Enabled, per Amplifier	No load, $V_{IN} = 0V$	1.3	1.5	1.7	mA
I_{SOFF-}	Supply Current - Disabled, per Amplifier	No load, $V_{IN} = 0V$	-25	-14	0	μA
I_{SOFF+}			0	10	+25	μA
PSRR	Power Supply Rejection Ratio	DC, $V_S = \pm 4.75V$ to $\pm 5.25V$	65	76		dB
-IPSR	- Input Current Power Supply Rejection	DC, $V_S = \pm 4.75V$ to $\pm 5.25V$	-0.5	0.1	+0.5	$\mu A/V$
ENABLE (EL5162, EL5262, EL5362 ONLY)						
t_{EN}	Enable Time			380		ns
t_{DIS}	Disable Time			800		ns
I_{IHCE}	\overline{CE} Pin Input High Current	$\overline{CE} = V_{S+}$	1	5	25	μA
I_{ILCE}	\overline{CE} Pin Input Low Current	$\overline{CE} = (V_{S+}) - 5V$	-1	0	+1	μA
V_{IHCE}	\overline{CE} Input High Voltage for Power-down		$V_{S+} - 1$			V
V_{ILCE}	\overline{CE} Input Low Voltage for Power-down				$V_{S+} - 3$	V

NOTE:

- Standard NTSC test, AC signal amplitude = 286mV_{p-p}, f = 3.58MHz

Typical Performance Curves

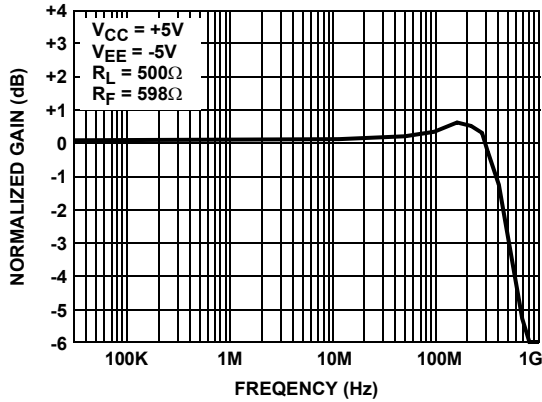

FIGURE 1. FREQUENCY RESPONSE FOR $A_V = +1$

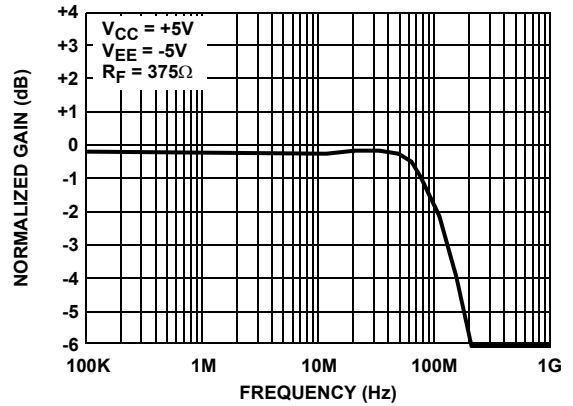

FIGURE 2. FREQUENCY RESPONSE FOR $A_V = +4.6$

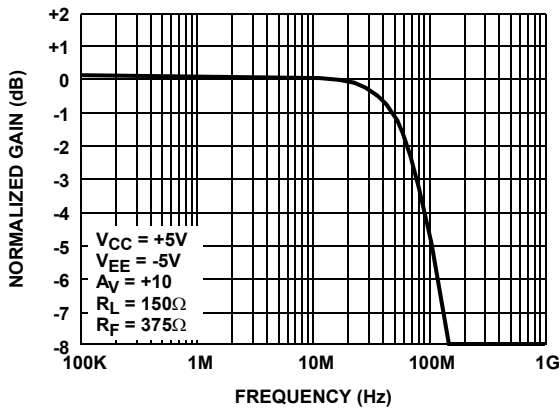

FIGURE 3. FREQUENCY RESPONSE FOR $A_V = +10$

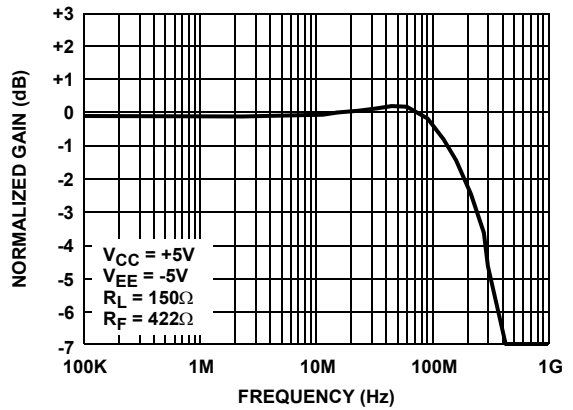

FIGURE 4. FREQUENCY RESPONSE FOR $A_V = +2$

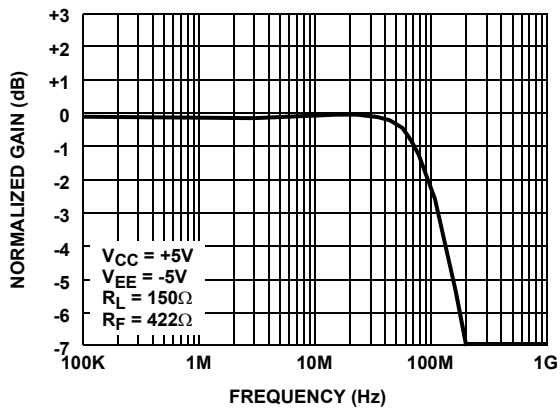

FIGURE 5. FREQUENCY RESPONSE FOR $A_V = +4$

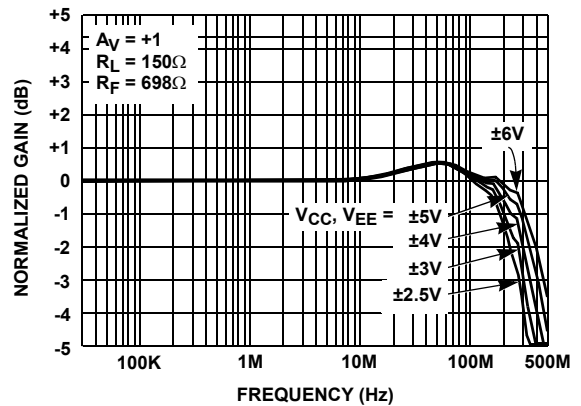

FIGURE 6. FREQUENCY RESPONSE FOR VARIOUS V_{CC} , V_{EE}

Typical Performance Curves (Continued)

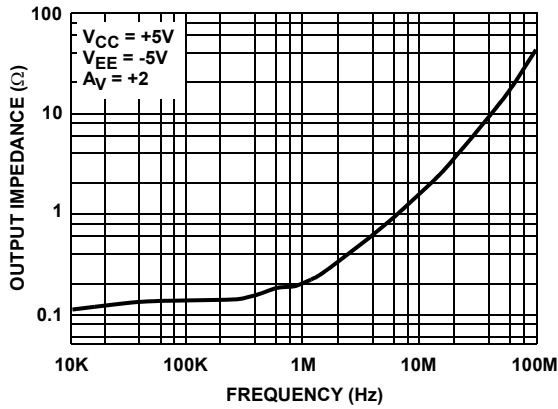

FIGURE 7. CLOSED LOOP OUTPUT IMPEDANCE

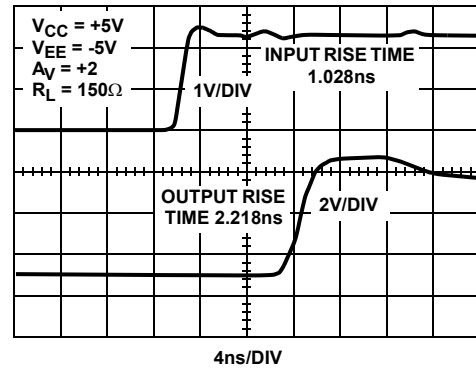

FIGURE 8. EL5262 OUTPUT RISE TIME

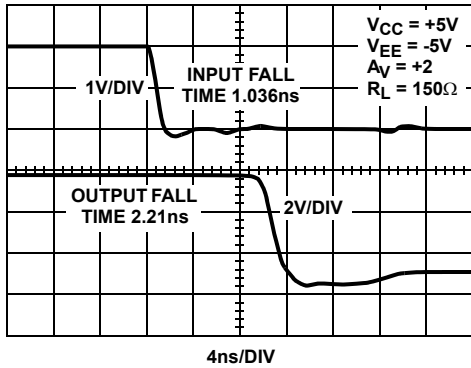

FIGURE 9. EL5262 OUTPUT FALL TIME

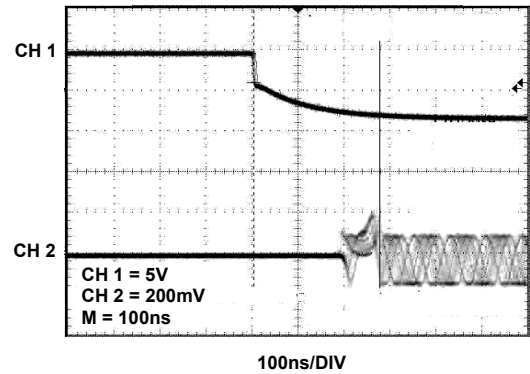

FIGURE 10. TURN ON TIME

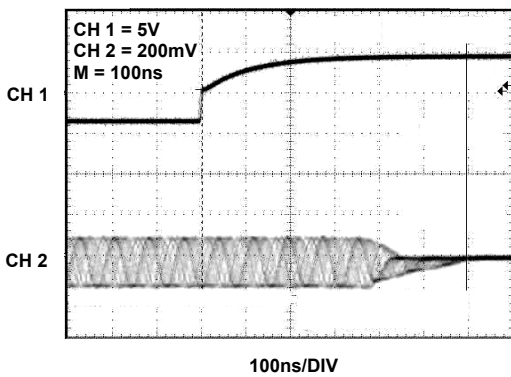

FIGURE 11. TURN OFF TIME

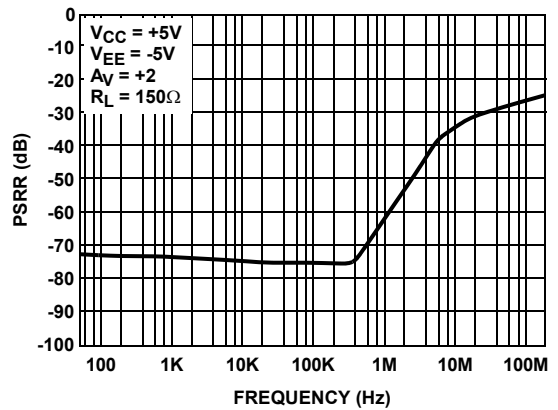

FIGURE 12. PSRR (VCC)

Typical Performance Curves (Continued)

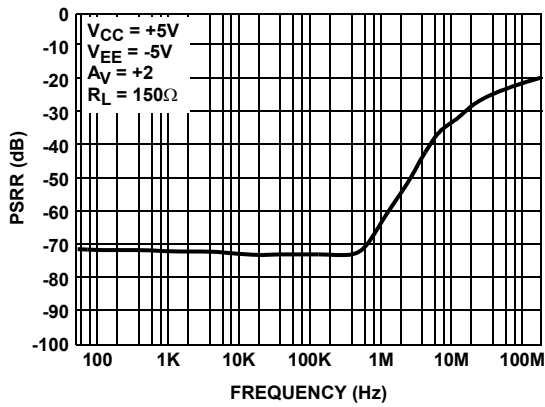

FIGURE 13. PSRR (V_{EE})

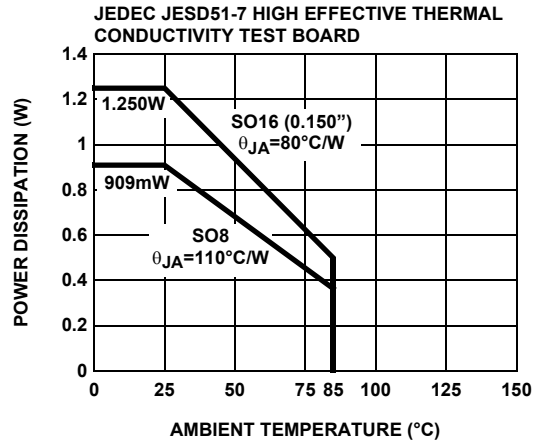

FIGURE 14. PACKAGE POWER DISSIPATION vs AMBIENT TEMPERATURE

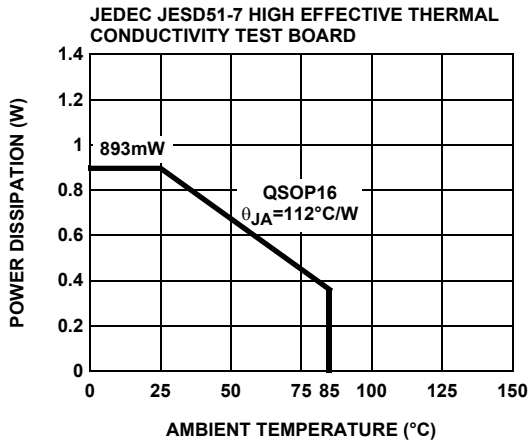

FIGURE 15. PACKAGE POWER DISSIPATION vs AMBIENT TEMPERATURE

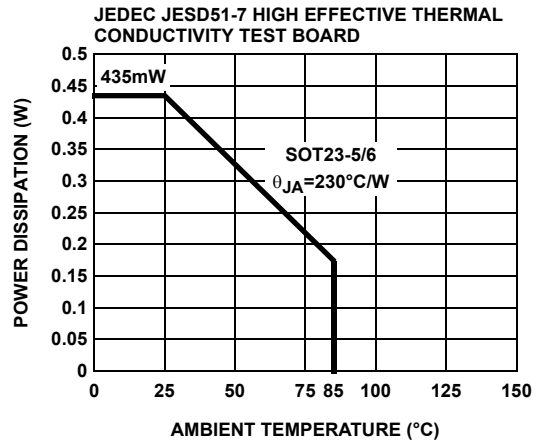

FIGURE 16. PACKAGE POWER DISSIPATION vs AMBIENT TEMPERATURE

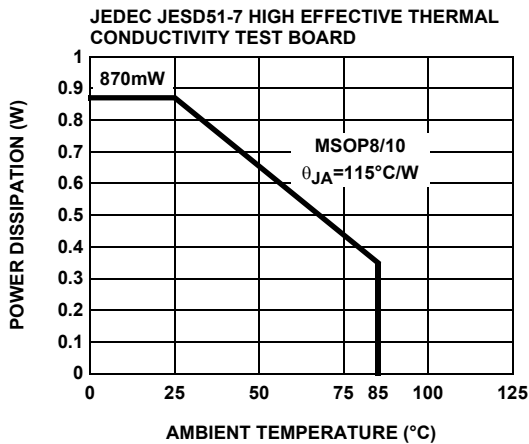

FIGURE 17. PACKAGE POWER DISSIPATION vs AMBIENT TEMPERATURE

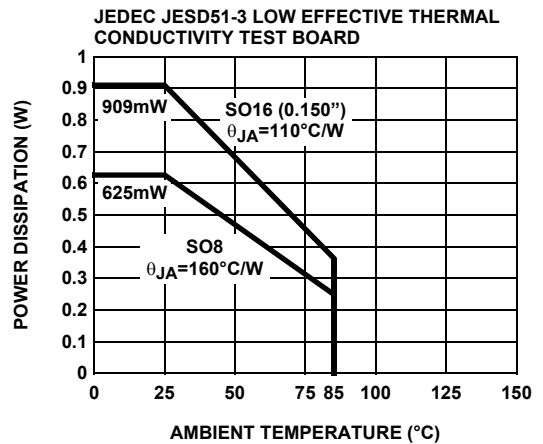

FIGURE 18. PACKAGE POWER DISSIPATION vs AMBIENT TEMPERATURE

Typical Performance Curves (Continued)

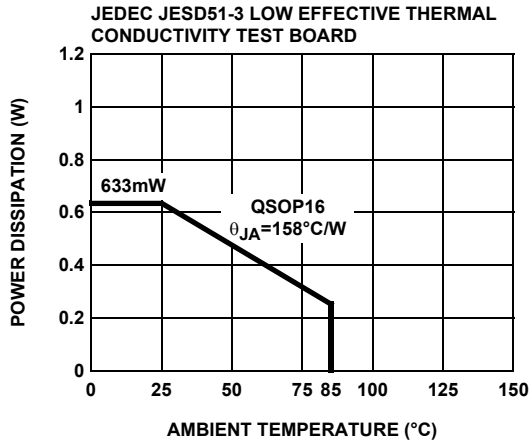

FIGURE 19. PACKAGE POWER DISSIPATION vs AMBIENT TEMPERATURE

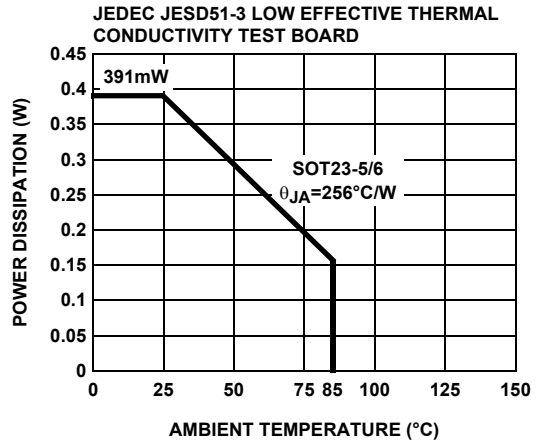

FIGURE 20. PACKAGE POWER DISSIPATION vs AMBIENT TEMPERATURE

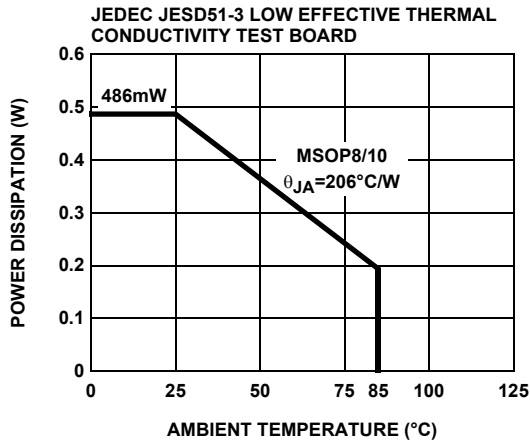

FIGURE 21. PACKAGE POWER DISSIPATION vs AMBIENT TEMPERATURE

All Intersil U.S. products are manufactured, assembled and tested utilizing ISO9000 quality systems. Intersil Corporation's quality certifications can be viewed at www.intersil.com/design/quality

Intersil products are sold by description only. Intersil Corporation reserves the right to make changes in circuit design, software and/or specifications at any time without notice. Accordingly, the reader is cautioned to verify that data sheets are current before placing orders. Information furnished by Intersil is believed to be accurate and reliable. However, no responsibility is assumed by Intersil or its subsidiaries for its use; nor for any infringements of patents or other rights of third parties which may result from its use. No license is granted by implication or otherwise under any patent or patent rights of Intersil or its subsidiaries.

For information regarding Intersil Corporation and its products, see www.intersil.com