

# Low Cost Two-Way GMIC SMT Power Divider 824 - 960 MHz



## Features

- Small Size and Low Profile
- Industry Standard SOT-26 SMT Plastic Package
- Typical Insertion Loss: 0.6dB
- Typical Isolation: 15dB
- 1 Watt Power Handling

## SOT-26

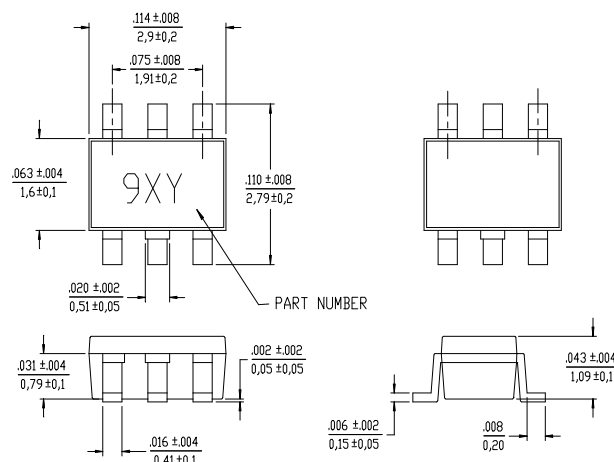

## Description

M/A-COM's DS52-0008 is an IC-based monolithic power divider using M/A-COM's GMIC technology in a low cost SOT-26 plastic package. This 2-way power divider is ideally suited for applications where small size, low insertion loss, superior phase/amplitude tracking and low cost are required. Typical applications include personal communications systems and other communication applications where size and PCB real estate are at a premium. Available in Tape and Reel.

The DS52-0008 is fabricated using a passive-integrated circuit process. The process features full-chip passivation for increased performance and reliability.

## Ordering Information

Part Number	Package
DS52-0008	SOT-26 Lead Plastic Package
DS52-0008-TR	Forward Tape and Reel <sup>1</sup>
DS52-0008-RTR	Reverse Tape and Reel <sup>1</sup>

1. If specific reel size is required, consult factory for part number assignment.

## Typical Electrical Specifications<sup>1</sup>, T<sub>A</sub> = +25°C

Parameter	Units	Min	Typ	Max
Insertion Loss above 3.0dB	dB	—	0.6	0.8
Isolation	dB	13	15	—
VSWR RF Input	—	—	1.3 : 1	1.4 : 1
Amplitude Balance	dB	—	0.1	0.25
Phase Balance	Degrees	—	3.0	5.0

1. All specifications apply with a 50-Ohm source and load impedance.

V1.01



M/A-COM ■ North America: Tel. (800) 366-2266, Fax (800) 618-8883 ■ Asia/Pacific: Tel.+85 2 2111 8088, Fax +85 2 2111 8087 ■ Europe: Tel. +44 (1344) 869 595, Fax+44 (1344) 300 020

www.macom.com

Specifications subject to change without notice.

**Absolute Maximum Ratings<sup>1</sup>**

Parameter	Absolute Maximum
Input Power <sup>2</sup>	1 W CW
Operating Temperature	-40°C to +85°C
Storage Temperature	-65°C to +150°C

1. Exceeding these limits may cause permanent damage.
2. With internal load dissipation of 0.125 W Maximum.

**Functional Diagram**

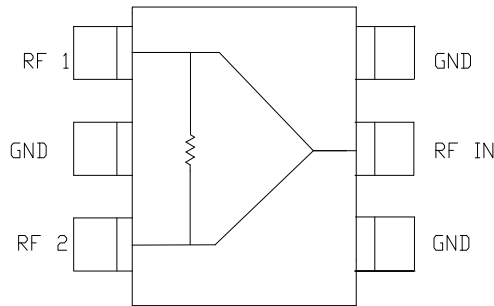

**Recommended PCB Configuration**

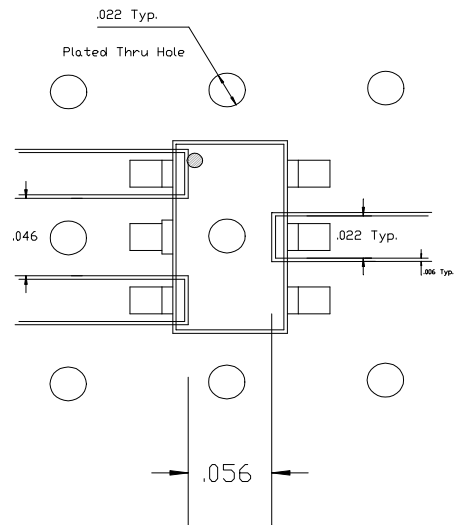

**Typical Performance @ +25°C**

**Insertion Loss**

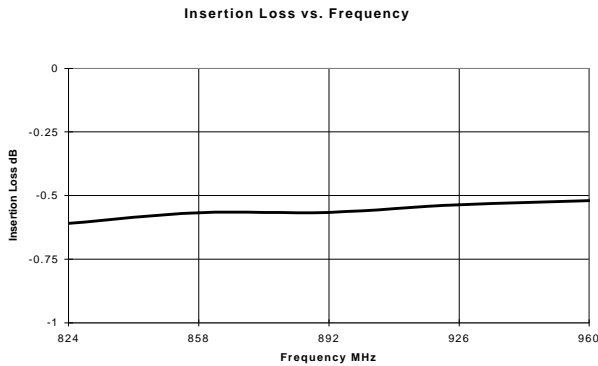

**Isolation**

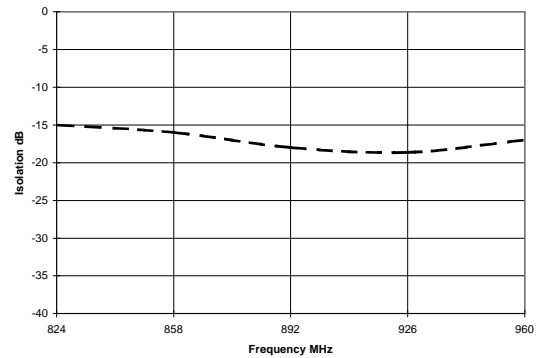

**VSWR**

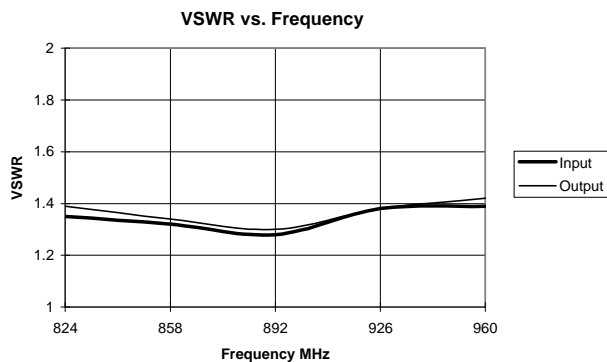

**Phase Balance**

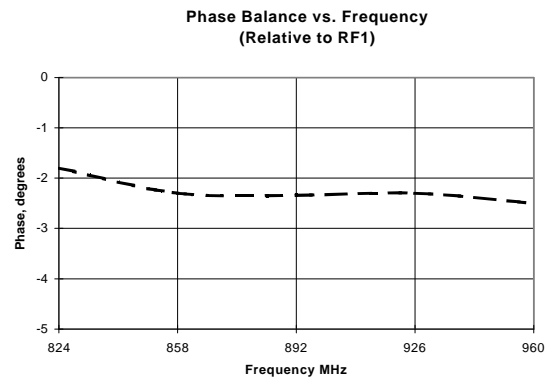

V1.01