

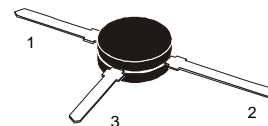
## The RF Line NPN Silicon High-Frequency Transistor

### DESCRIPTION

The BFR91A is an NPN silicon epitaxial transistor designed for low noise amplifier at VHF, UHF and CATV band.

It has dynamic range and good current characteristic.

This small-signal plastic transistor offers superior quality and performance at low cost.



1 – Base  
2 – Collector  
3 – Emitter

### FEATURES

- High Gain-Bandwidth Products  
 $f_T = 6.0$  GHz (Typ) @ 30 mA
- Low Noise Figure  
 $N_F = 1.6$  dB (Typ) @ 800 MHz
- High Gain  
 $G_{PS} = 13.0$  dB (Typ) @ 800 MHz

	SOT37
JEDEC	TO-50
EIAJ	-
GOST	KT-29
Weight:	0.2g

### ABSOLUTE MAXIMUM RATINGS ( $T_A = 25$ °C)

Rating	Symbol	Value	Unit
Collector- Emitter Voltage	$V_{CEO}$	12	V
Collector- Base Voltage	$V_{CBO}$	20	V
Emitter- Base Voltage	$V_{EBO}$	2	V
Collector Current	$I_C$	50	mA
Power Dissipation	$P_{tot}$	300	mW
Junction Temperature	$T_{JMAX}$	150	°C
Operating Junction Temperature Range	$T_J$	-45 to +70	°C
Storage Temperature Range	$T_{STG}$	-65 to +150	°C

### THERMAL CHARACTERISTIC

Thermal Resistance, Junction to Case	$R_{\theta JC}$	400	°C/W
--------------------------------------	-----------------	-----	------

### ORDERING INFORMATION

Device	Marking	Package	Quantity	Packing Style
BFR91A	BFR91A	SOT-37	1 Kpcs / plastic bags	In bulk

# BFR91A

## ELECTRICAL CHARACTERISTICS ( $T_A = 25\text{ }^\circ\text{C}$ unless otherwise noted)

Characteristic	Symbol	Min	Typ	Max	Unit
<b>DC CHARACTERISTICS</b>					
Collector Cutoff Current, $I_E = 0\text{mA}, V_{CB} = 10\text{V}$	$I_{CBO}$	–	–	<b>100</b>	nA
Emitter Cutoff Current, $I_C = 0\text{mA}, V_{EB} = 2\text{V}$	$I_{EBO}$	–	–	<b>10</b>	$\mu\text{A}$
Collector – Emitter Breakdown Voltage, $I_C = 1\text{mA}, I_B = 0\text{mA}$	$V_{(BR)CEO}$	<b>12</b>	–	–	V
DC Current Gain, $I_E = 30\text{mA}, V_{CB} = 5\text{V}$	$h_{FE}$	<b>50</b>	<b>120</b>	<b>300</b>	–
Collector – Emitter Saturation Voltage, $I_C = 1\text{mA}, I_B = 0\text{mA}$	$V_{CE(sat)}$	–	<b>100</b>	<b>400</b>	mV

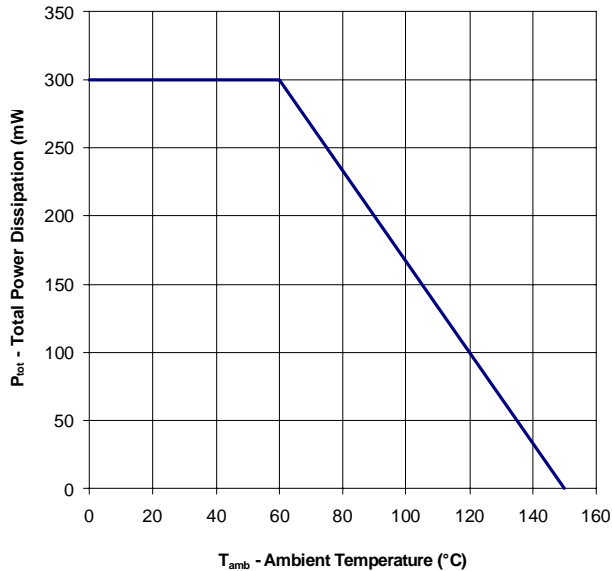
## AC CHARACTERISTICS

Transition Frequency, $I_C = 30\text{mA}, V_{CB} = 5\text{V}, f = 300\text{MHz}$	$f_T$	<b>4.5</b>	<b>6.0</b>	–	GHz
Collector-Base Capacitance, $I_E = 0\text{mA}, V_{CB} = 10\text{V}, f = 1\text{MHz}$	$C_{cb}$	–	<b>0.4</b>	<b>0.9</b>	pF
Noise Figure, $I_E = 5\text{mA}, V_{CE} = 8\text{V}, f = 800\text{MHz}$	$N_F$	–	<b>1.6</b>	<b>2.0</b>	dB
Power Gain, $I_E = 30\text{mA}, V_{CE} = 8\text{V}, f = 800\text{MHz}$	$G_{PS}$	<b>12.0</b>	<b>13.0</b>	–	dB

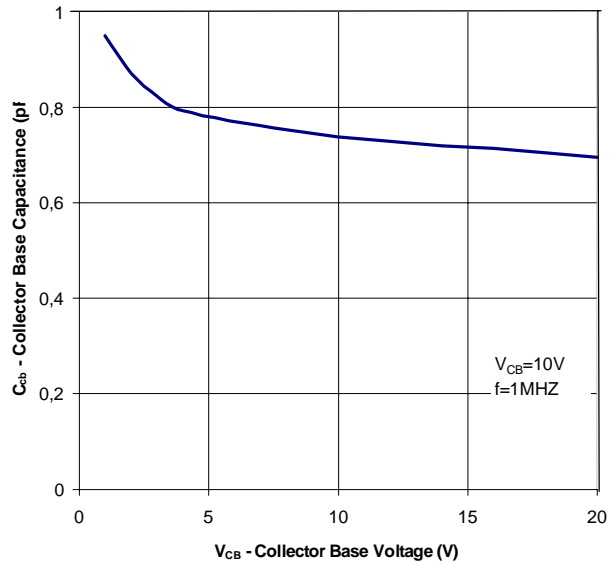
## $h_{FE}$ CLASSIFICATION

Class	K	H	F	E
$h_{FE}$	<b>50 to 300</b>	<b>50 to 100</b>	<b>80 to 160</b>	<b>125 to 250</b>

## TYPICAL CHARACTERISTICS ( $T_A = 25\text{ }^\circ\text{C}$ unless otherwise noted)

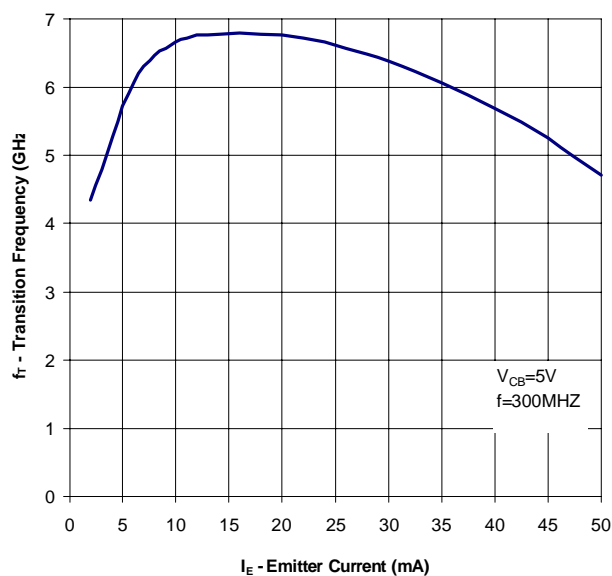


**Figure 1.** Total Power Dissipation vs. Ambient Temperature

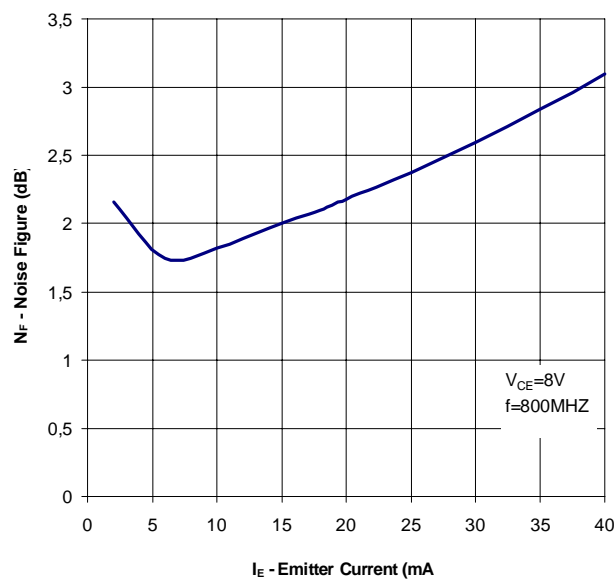


**Figure 2.** Collector – Base Capacitance vs. Collector – Base Voltage

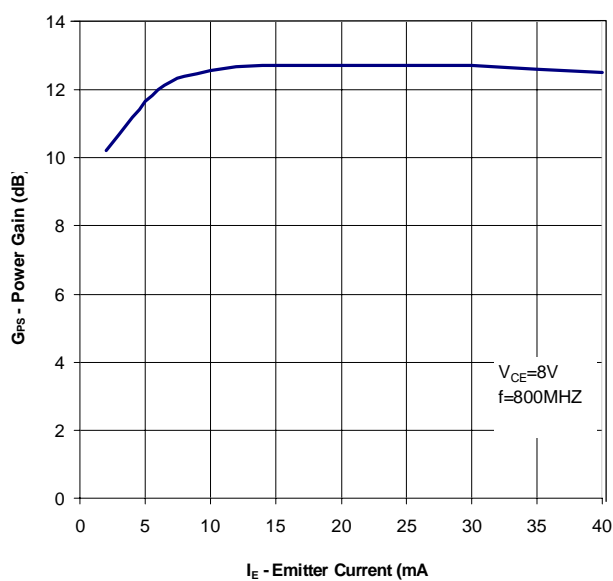
## TYPICAL CHARACTERISTICS ( $T_A = 25\text{ }^\circ\text{C}$ unless otherwise noted)



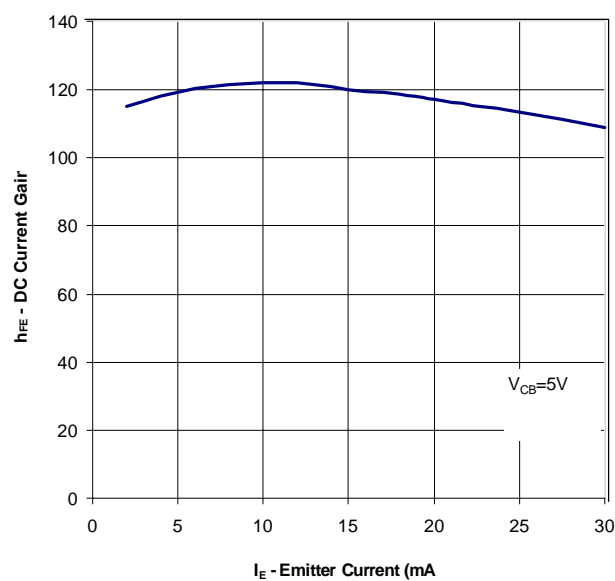
**Figure 3.** Transition Frequency vs. Emitter Current



**Figure 4.** Noise Figure vs. Emitter Current



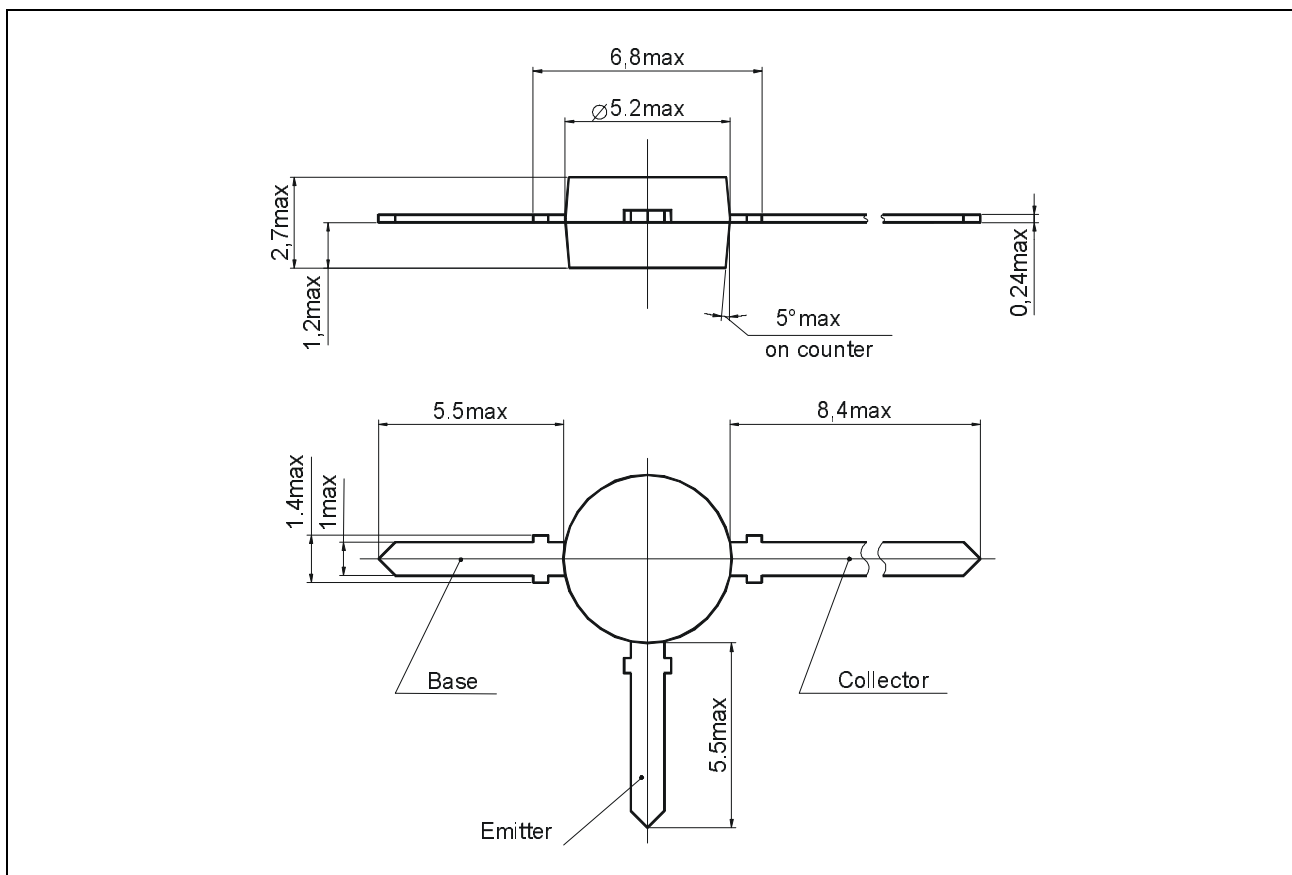
**Figure 5.** Power Gain vs. Emitter Current



**Figure 6.** DC Current Gain vs. Emitter Current

# BFR91A

## PACKAGE DIMENSIONS in mm



## PLASTIC CASE KT-29