

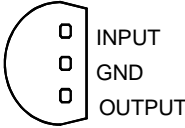
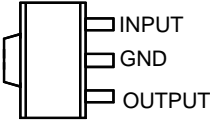
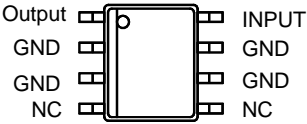

AMC78L05

100mA / 3-TERMINAL 5V REGULATOR

DESCRIPTION	FEATURES
<p>The AMC78L05 is a 3-terminal positive regulator with a fixed output voltage of 5V. Although it is designed as a fixed-voltage regulator, the output voltage can be increased by the use of a simple voltage divider. This regulator can provide local on card regulation, eliminating the distribution problems associated with single point regulation. In addition, it can be used with power-pass elements to make high-current voltage regulators with 100mA output current.</p> <p>Protection features such as thermal shutdown and current limiting have been designed internally which will protect the device from damage in case of overload or overheating.</p>	<ul style="list-style-type: none"> ■ ±5% tolerance of output voltage ■ Wide input range ■ Output current $\geq 100\text{mA}$ ■ Internal thermal overload protection ■ No External Components □ Short circuit protection □ Available in 3L plastic TO-92, surface mount SOT-89 and plastic 8 pin S.O.I.C. □ Identical pin assignment to earlier 78L05 series.

APPLICATIONS	PACKAGE PIN OUT
<ul style="list-style-type: none"> ■ Logic Systems ■ Computer Add-On Cards ■ Monitors ■ Power Suppliers 	<div style="display: flex; justify-content: space-around; align-items: flex-start;"> <div style="text-align: center;">  <p>3-Pin Plastic TO-92 (Top View)</p> </div> <div style="text-align: center;">  <p>3-Pin Plastic SOT-89 Surface Mount (TOP View)</p> </div> </div> <div style="text-align: center; margin-top: 20px;">  <p>8-Pin S.O.I.C Surface Mount (Top View)</p> </div>

ORDER INFORMATION						
T_A (°C)	LP	TO-92	DM	SO-8	PK	SOT-89
		3-pin		8-pin		3-pin
0 to 70		AMC78L05LP(SnPb)		AMC78L05DM(SnPb)		AMC78L05PK(SnPb)
0 to 70		AMC78L05LPF(Lead Free)		AMC78L05DMF(Lead Free)		AMC78L05PKF(Lead Free)
<p>Note: 1. All surface-mount and TO-92 packages are available in Tape & Reel. Append the letter "T" to part number (i.e. AMC78L05LPT, AMC78L05DMT or AMC78L05PKT).</p> <p>2. For TO-92 in Tape & Box (without reel), add suffix "TB" (i.e. AMC78L05LPTB)</p> <p>3. The letter "F" is marked for Lead Free process .</p>						

ABSOLUTE MAXIMUM RATINGS (Note 1)	
Input Voltage	30V
Maximum junction operating temperature, T_J	150°C
Storage temperature range	-65°C to 150°C
Lead temperature (soldering, 10 seconds)	260°C
Note 1: Exceeding these ratings could cause damage to the device. All voltages are with respect to Ground. Currents are positive into, negative out of the specified terminal.	

POWER DISSIPATION TABLE					
Package	θ_{JA} (°C/W)	Derating factor (mW/°C) $T_A \geq 25^\circ\text{C}$	$T_A \leq 25^\circ\text{C}$	$T_A = 70^\circ\text{C}$	$T_A = 85^\circ\text{C}$
			Power rating(mW)	Power rating(mW)	Power rating (mW)
DM	165	6.06	757	485	394
DMF	165	6.06	757	485	394
LP	156	6.41	801	513	417
LPF	156	6.41	801	513	417
PK	71(note)	14.1	1763	1128	916
PKF	71(note)	14.1	1763	1128	916
Note : 1.For PK package, Thermal Resistance-Junction to Tab (θ_{JT}) = 35 °C/W. $T_J = T_{TAB} + (P_D \times \theta_{JT})$. P_D : Power Dissipation. 2. θ_{JA} : Thermal Resistance-Junction to Ambient Junction Temperature Calculation: $T_J = T_A + (P_D \times \theta_{JA})$. The θ_{JA} numbers are guidelines for the thermal performance of the device/PC-board system. All of the above assume no ambient airflow.					

RECOMMENDED OPERATING CONDITIONS					
Parameter	Symbol	Recommended Operating Conditions			Units
		Min.	Typ.	Max.	
Input Voltage	V_I	7		20	V
Output Current	I_{OUT}			100	mA
Operating Virtual Junction Temperature	T_J	0		125	°C

ELECTRICAL CHARACTERISTICS						
Unless otherwise specified, these specifications in bold type apply over the operating temperature range of $0^{\circ}\text{C} \leq T_J \leq +150^{\circ}\text{C}$, $V_{IN} = 10\text{V}$, $I_{OUT} = 40\text{mA}$, $C_{IN} = 0.33\mu\text{F}$, $C_{OUT} = 0.1\mu\text{F}$, and are for DC characteristics only. (Low duty cycle pulse testing techniques are used which maintains junction and case temperatures equal to the ambient temperature.)						
Parameter	Symbol	Test Conditions	AMC78L05			Units
			Min.	Typ.	Max.	
Output Voltage	V_{OUT}	$T_J = 25^{\circ}\text{C}$	4.8	5.0	5.2	V
		$7\text{V} \leq V_{IN} \leq 20\text{V}$, $1\text{mA} \leq I_{OUT} \leq 40\text{mA}$	4.75		5.25	
		$1\text{mA} \leq I_{OUT} \leq 70\text{mA}$	4.75		5.25	
Line Regulation	ΔV_{OI}	$7\text{V} \leq V_{IN} \leq 20\text{V}$, $T_J = 25^{\circ}\text{C}$		18	75	mV
		$8\text{V} \leq V_{IN} \leq 20\text{V}$, $T_J = 25^{\circ}\text{C}$		10	54	
Load Regulation	ΔV_{OL}	$1\text{mA} \leq I_{OUT} \leq 100\text{mA}$, $T_J = 25^{\circ}\text{C}$		20	60	mV
		$1\text{mA} \leq I_{OUT} \leq 40\text{mA}$, $T_J = 25^{\circ}\text{C}$		5	30	
Peak Output Current	I_{PEAK}	$T_J = 25^{\circ}\text{C}$		140		mA
Dropout Voltage		$T_J = 25^{\circ}\text{C}$		1.7	2.0	V
Quiescent Current	I_Q			3	5	mA
Ripple Rejection (note 1)	R_R	$f = 120\text{Hz}$, $8\text{V} \leq V_{IN} \leq 16\text{V}$, $T_J = 25^{\circ}\text{C}$	47	62		dB
Output Noise Voltage (note 1)	$V_{O,RMS}$	$10\text{Hz} \leq f \leq 100\text{KHz}$, $T_J = 25^{\circ}\text{C}$		40		μV

Note 1: These parameters, although guaranteed, are not 100% tested in production prior to shipment.

Typical Applications

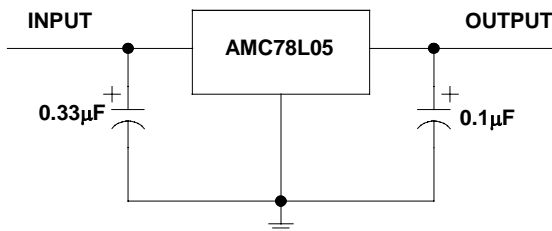

Fig. 1. Fixed Output Regulator – capacitors are required if the regulator is far away from the power supply filter.

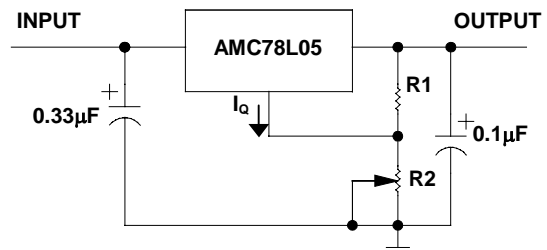

Fig. 2. Adjustable Output Regulator –

$$V_{OUT} = 5\text{V} + (5\text{V}/R1 + I_Q)R2$$

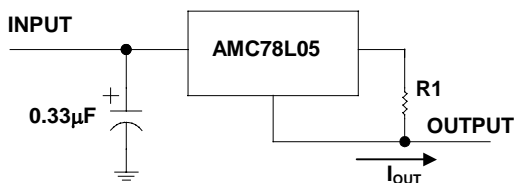

Fig. 3. Current Regulator:

$$I_{OUT} = (V_{OUT} / R1) + I_Q$$

3-Pin Plastic TO-92

	INCHES			MILLIMETERS		
	MIN	TYP	MAX	MIN	TYP	MAX
A	0.175	0.180	0.205	4.45	4.57	5.21
B	0.170	0.180	0.210	4.32	4.57	5.33
C	0.125	0.142	0.165	3.18	3.62	4.19
F	-	0.015	-	-	0.38	-
G	-	0.050	-	-	1.27	-
J	-	0.150	-	-	3.81	-
K	0.500	0.580	-	12.70	14.73	-
M	-	5°	-	-	5°	-
N	-	5°	-	-	5°	-

Note: For TO-92 in tape and reel, refer to TO-92 package and carrier dimension data for lead dimensions.

3-Pin Plastic TO-92 Package (Taped and Reeled) and Carrier Dimensions

	INCHES			MILLIMETERS		
	MIN	TYP	MAX	MIN	TYP	MAX
C	0.079	-	-	2.00	-	-
P	0.480	0.500	0.520	12.2	12.7	13.2
Po	0.488	0.500	0.512	12.4	12.7	13.0
Do	0.150	0.157	0.165	3.8	4.0	4.2
P1	0.230	0.250	0.256	5.85	6.35	6.85
Fo	0.165	0.197	0.220	4.2	5.0	5.6
W	0.669	0.709	0.748	17.0	18.0	19.0
Ho	0.610	0.630	0.649	15.5	16.0	16.5
Wo	0.224	0.236	0.248	5.7	6.0	6.3
W1	0.335	0.354	0.374	8.5	9.0	9.5

Note: For 3L TO92, 2,000 units per Reel

8-Pin Plastic S.O.I.C.

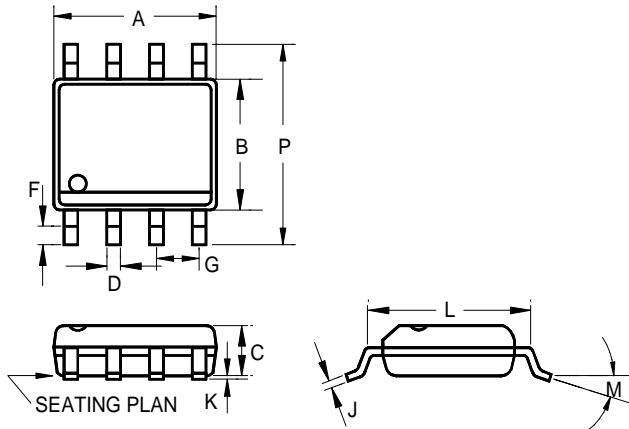

Note: for 8 pin S.O.I.C., 100 units per tube

	INCHES			MILLIMETERS		
	MIN	TYP	MAX	MIN	TYP	MAX
A	0.183	-	0.202	4.65	-	5.13
B	0.144	-	0.163	3.66	-	4.14
C	0.068	-	0.074	1.73	-	1.88
D	0.010	-	0.020	0.25	-	0.51
F	0.015	-	0.035	0.38	-	0.89
G	0.050 BSC			1.27 BSC		
J	0.007	-	0.010	0.19	-	0.25
K	0.005	-	0.010	0.13	-	0.25
L	0.189	-	0.205	4.80	-	5.21
M	-	-	8°	-	-	8°
P	0.228	-	0.244	5.79	-	6.20

3-Pin Surface Mount SOT-89

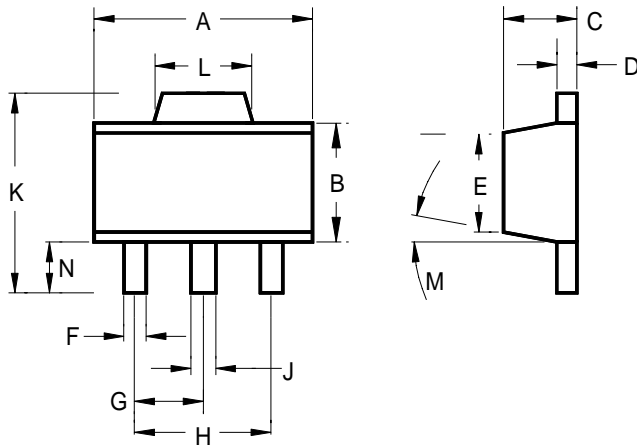

	INCHES			MILLIMETERS		
	MIN	TYP	MAX	MIN	TYP	MAX
A	0.173	-	0.181	4.39	-	4.59
B	0.090	-	0.102	2.28	-	2.59
C	0.055	-	0.063	1.39	-	1.60
D	0.015	-	0.017	0.38	-	0.43
E	0.084	-	0.090	2.13	-	2.28
F	0.016	-	0.019	0.33	-	0.48
G	0.059 BSC			1.49 BSC		
H	0.118 BSC			2.99 BSC		
J	0.018	-	0.022	0.45	-	0.55
K	0.155	-	0.167	3.94	-	4.24
L	0.067	-	0.072	1.70	-	1.82
M	0°	-	8°	0°	-	8°
N	0.035	-	0.047	0.89	-	1.19

IMPORTANT NOTICE

ADD Microtech (ADDM) reserves the right to make changes to its products or to discontinue any integrated circuit product or service without notice, and advises its customers to obtain the latest version of relevant information to verify, before placing orders, that the information being relied on is current.

A few applications using integrated circuit products may involve potential risks of death, personal injury, or severe property or environmental damage. ADDM integrated circuit products are not designed, intended, authorized, or warranted to be suitable for use in life-support applications, devices or systems or other critical applications. Use of ADDM products in such applications is understood to be fully at the risk of the customer. In order to minimize risks associated with the customer's applications, the customer should provide adequate design and operating safeguards.

ADDM assumes no liability to customer product design or application support. ADDM warrants the performance of its products to the specifications applicable at the time of sale.

U.S.

ADD Microtech Inc.
492 Altamont Drive
Milpitas, CA 95035

TEL: (408) 9410420
FAX: (408) 9410864

Asia Pacific region

ADD Microtech Corp
13F, NO. 287, Sec. 3, Nan Jing E. Rd.,
Taipei, Taiwan 105

TEL: 2-27132800
FAX: 2-27132805