

FEATURES

- Ultralow Power: $I_{IN} = 13\mu A$
- Regulated 5V $\pm 4\%$ Output Voltage
- Output Current: 100mA ($V_{IN} = 3.3V$)
110mA ($V_{IN} = 3.6V$)
- Input Range: 2.7V to 5.0V
- No Inductors Needed
- Very Low Shutdown Current: $< 1\mu A$
- Internal Oscillator: 650KHz
- Short-Circuit and Overtemperature Protection
- 6-Pin SOT-23 Package

APPLICATIONS

- White or Blue LED Backlighting
- SIM Interface Supplies for Cellular Telephones
- Li-Ion Battery Backup Supplies
- Local 3V to 5V Conversion
- Smart Card Readers
- PCMCIA Local 5V Supplies

TYPICAL APPLICATION CIRCUIT

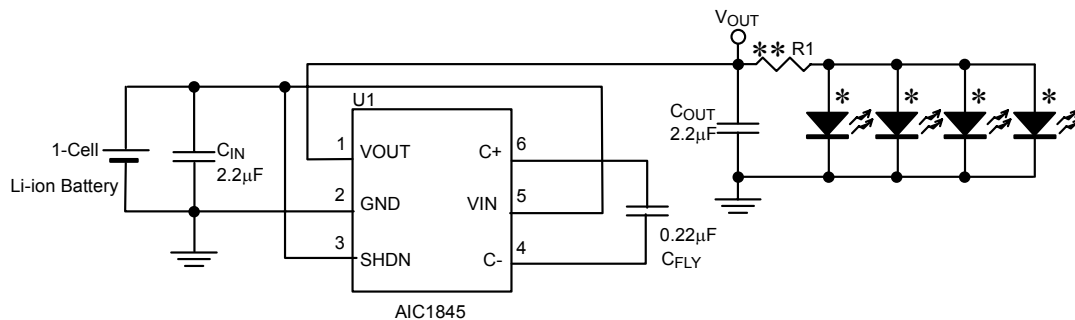

Regulated 5V Output from 2.7V to 5.0V Input

* WLED series number: NSPW310BS, $V_F = 3.6V$, $I_F = 20mA$

** $R1 = \frac{V_{OUT} - V_F}{I_F \times N_{WLED}}$, N_{WLED} : The number of WLED

C_{IN} , C_{OUT} : CELMK212BJ225MG (X5R) (0805), TAIYO YUDEN

C_{FLY} : CEEMK212BJ224KG (X7R) (0805), TAIYO YUDEN

DESCRIPTION

The AIC1845 is a micropower charge pump DC/DC converter that produces a regulated 5V output. The input voltage range is 2.7V to 5.0V. Extremely low operating current (13 μA typical with no load) and a low external-part count (one 0.22 μF flying capacitor and two small bypass capacitors at V_{IN} and V_{OUT}) make the AIC1845 ideally suitable for small, battery-powered applications.

The AIC1845 operates as a PSM (Pulse Skipping Modulation) mode switched capacitor voltage doubler to produce a regulated output and features with thermal shutdown capability and short circuit protection.

The AIC1845 is available in a 6-pin SOT-23 package.

ORDERING INFORMATION

AIC1845XXXX

- PACKING TYPE
TR: TAPE & REEL
BG: BAG
- PACKAGE TYPE
G: SOT-23-6
- C: COMMERCIAL
P: LEAD FREE COMMERCIAL

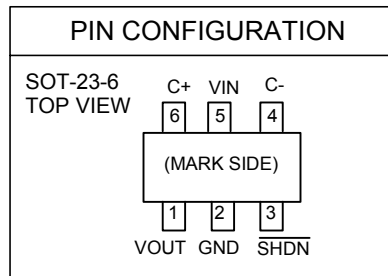

Example: AIC1845CGTR
 → in SOT-23-6 Package & Taping & Reel Packing Type
 AIC1845PGTR
 → in Lead Free SOT-23-6 Package & Taping & Reel Packing Type

● **SOT-23-6 Marking**

Part No.	Marking
AIC1845CG	BO50
AIC1845PG	BO50P

ABSOLUTE MAXIMUM RATINGS

VIN to GND6V
 VOUT to GND6V
 All Other Pins to GND6V
 VOUT Short-Circuit Duration Continuous
 Operating Temperature Range -40°C to 85 °C
 Junction Temperature 125°C
 Storage Temperature Range -65°C to 150 °C
 Lead Temperature (Soldering 10 Sec.) 260°C

Absolute Maximum Ratings are those values beyond which the life of a device may be impaired.

TEST CIRCUIT

Refer to TYPICAL APPLICATION CIRCUIT.

ELECTRICAL CHARACTERISTICS

($T_A=25^{\circ}\text{C}$, $C_{\text{FLY}}=0.22\mu\text{F}$, $C_{\text{IN}}=2.2\mu\text{F}$, $C_{\text{OUT}}=2.2\mu\text{F}$, unless otherwise specified.) (Note 1)

PARAMETER	TEST CONDITIONS	SYMBOL	MIN.	TYP.	MAX.	UNIT
Input Voltage		V_{IN}	2.7		5.0	V
Output Voltage	$2.7\text{V} \leq V_{\text{IN}} < 3.3\text{V}$, $I_{\text{OUT}} \leq 30\text{mA}$	V_{OUT}	4.8	5.0	5.2	V
	$3.3\text{V} \leq V_{\text{IN}} \leq 5.0\text{V}$, $I_{\text{OUT}} \leq 60\text{mA}$		4.8	5.0	5.2	
Continuous Output Current	$V_{\text{IN}}=3\text{V}$, $V_{\text{OUT}}=5.0\text{V}$ $\overline{\text{SHDN}} = V_{\text{IN}}$	I_{OUT}	60			mA
Supply Current	$2.7\text{V} \leq V_{\text{IN}} \leq 5.0\text{V}$, $I_{\text{OUT}}=0$, $\overline{\text{SHDN}} = V_{\text{IN}}$	I_{CC}		13	30	μA
Shutdown Current	$2.7\text{V} \leq V_{\text{IN}} \leq 5.0\text{V}$, $I_{\text{OUT}}=0$, $\overline{\text{SHDN}} = 0\text{V}$	$I_{\overline{\text{SHDN}}}$		0.01	1.0	μA
Output Ripple	$V_{\text{IN}}=3\text{V}$, $I_{\text{OUT}}=50\text{mA}$	V_{R}		60		mV
Efficiency	$V_{\text{IN}}=2.7\text{V}$, $I_{\text{OUT}}=30\text{mA}$	η		83		%
Switching Frequency	Oscillator Free Running	f_{OSC}		650		KHz
Shutdown Input Threshold (High)		V_{IH}	1.4			V
Shutdown Input Threshold (Low)		V_{IL}			0.3	V
Shutdown Input Current (High)	$\overline{\text{SHDN}} = V_{\text{IN}}$	I_{IH}	-1		1	μA
Shutdown Input Current (Low)	$\overline{\text{SHDN}} = 0\text{V}$	I_{IL}	-1		1	μA
Vout Turn On Time	$V_{\text{IN}}=3\text{V}$, $I_{\text{OUT}}=0\text{mA}$	t_{ON}		0.5		mS
Output Short Circuit Current	$V_{\text{IN}}=3\text{V}$, $V_{\text{OUT}}=0\text{V}$, $\overline{\text{SHDN}} = V_{\text{IN}}$	I_{SC}		170		mA

Note1: Specifications are production tested at $T_A=25^{\circ}\text{C}$. Specifications over the -40°C to 85°C operating temperature range are assured by design, characterization and correlation with Statistical Quality Controls (SQC).

TYPICAL PERFORMANCE CHARACTERISTICS

(C_{IN} , C_{OUT} : CELMK212BJ225MG, C_{FLY} : CEEMK212BJ224KG)

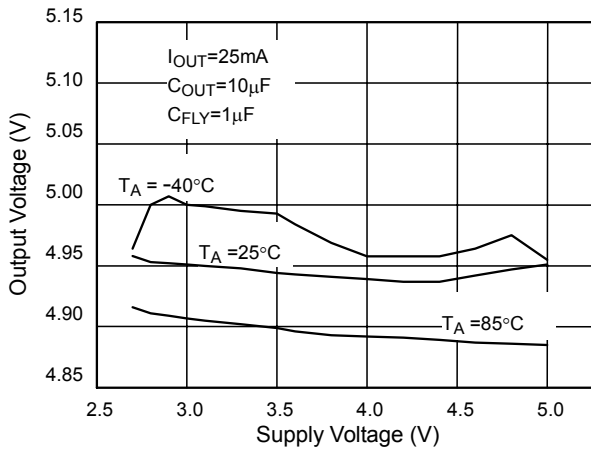

Fig. 1 Line Regulation

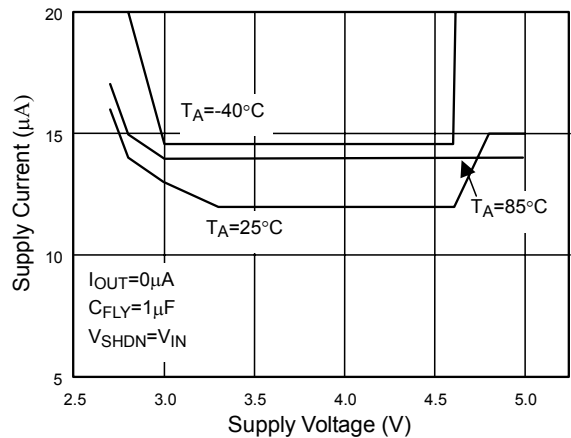

Fig. 2 No Load Supply Current vs. Supply Voltage

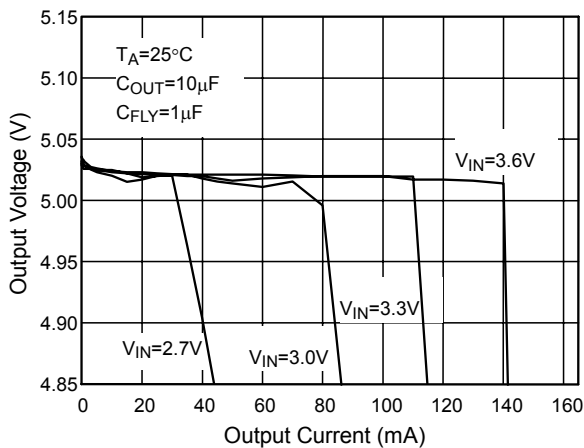

Fig. 3 Load Regulation

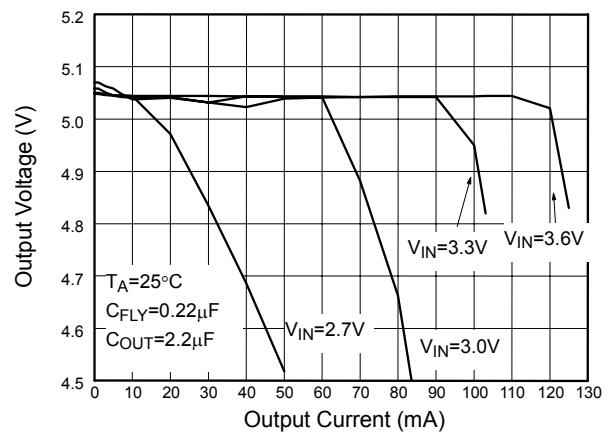

Fig. 4 Load Regulation

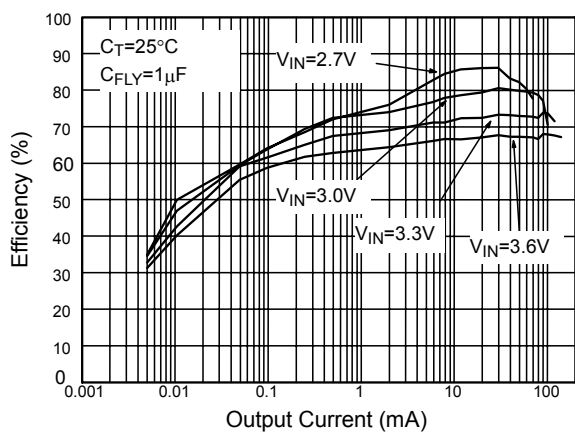

Fig. 5 Efficiency

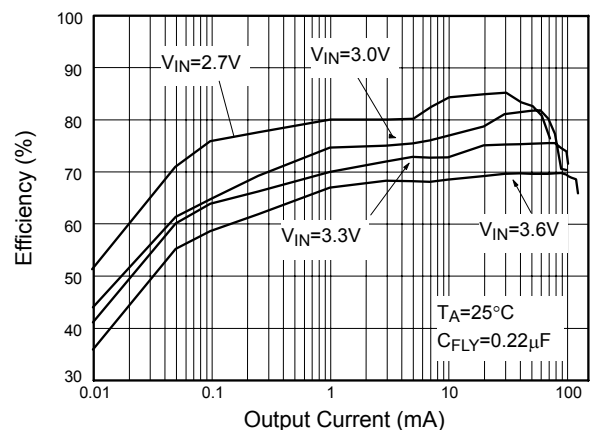

Fig. 6 Efficiency

TYPICAL PERFORMANCE CHARACTERISTICS (Continued)

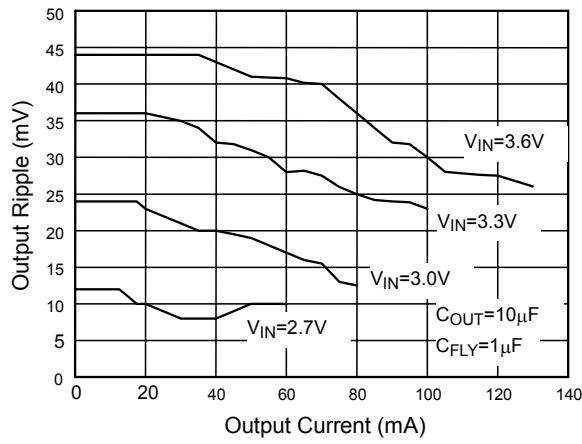

Fig. 7 Output Current vs. Output Ripple

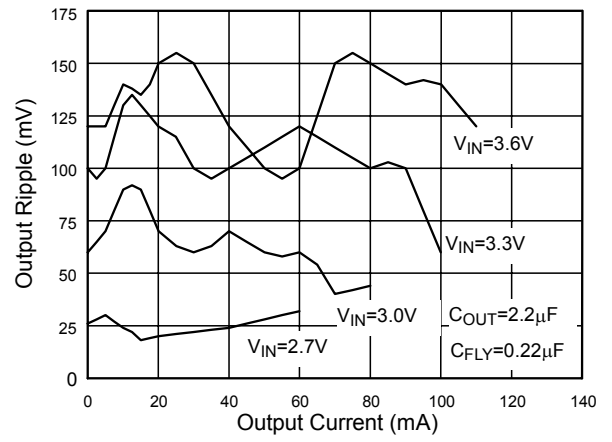

Fig. 8 Output Current vs. Output Ripple

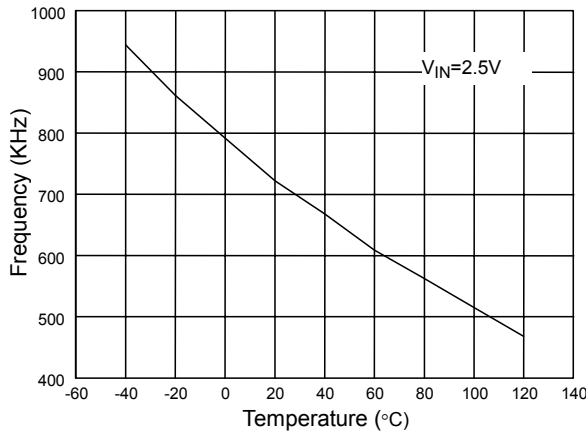

Fig. 9 Frequency vs. Temperature

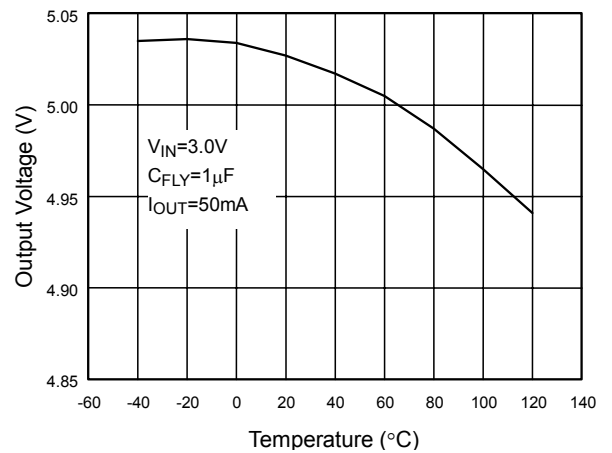

Fig. 10 Output Voltage vs. Temperature

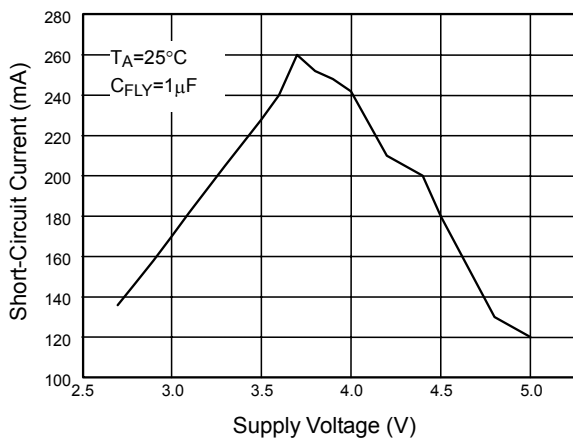

Fig. 11 Short-Circuit Current vs. Supply Voltage

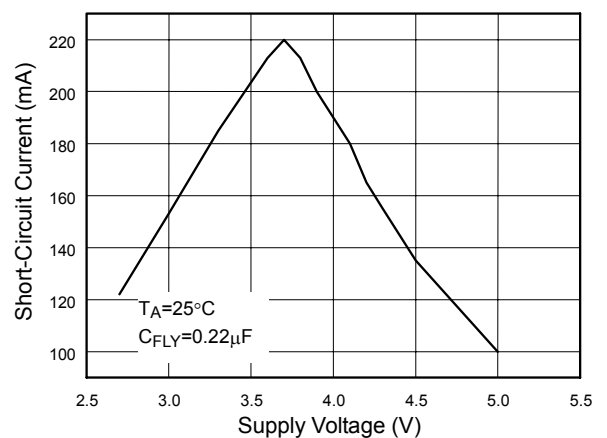

Fig. 12 Short-Circuit Current vs. Supply Voltage

TYPICAL PERFORMANCE CHARACTERISTICS (Continued)

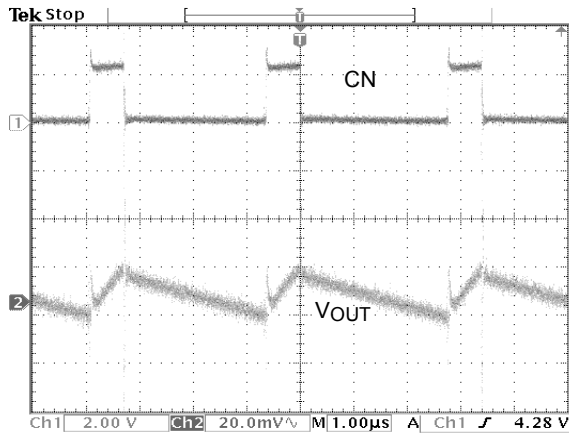

Fig. 13 Output Ripple

$V_{IN}=3.0V, I_{OUT}=50mA, C_{OUT}=10\mu F, C_{FLY}=1\mu F$

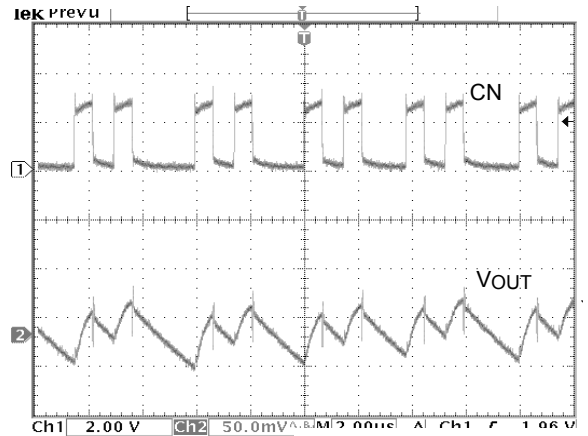

Fig. 14 Output Ripple

$V_{IN}=3.0V, I_{OUT}=50mA, C_{OUT}=2.2\mu F, C_{FLY}=0.22\mu F$

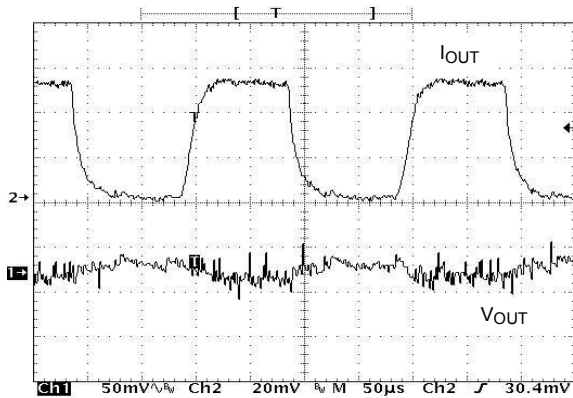

Fig. 15 Load Transient Response

$V_{IN}=3.0V, I_{OUT}=0mA\sim 50mA, C_{OUT}=10\mu F, C_{FLY}=1\mu F$

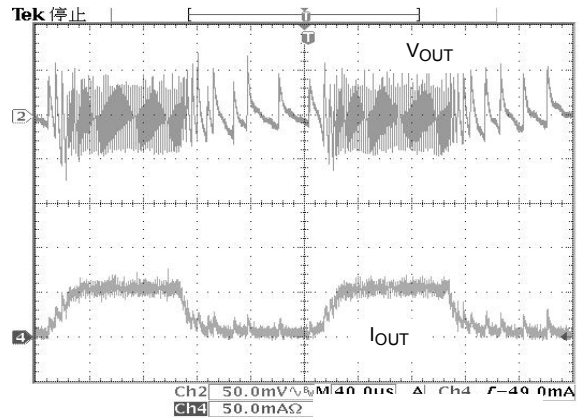

Fig. 16 Load Transient Response

$V_{IN}=3.0V, I_{OUT}=0mA\sim 50mA, C_{OUT}=2.2\mu F, C_{FLY}=0.22\mu F$

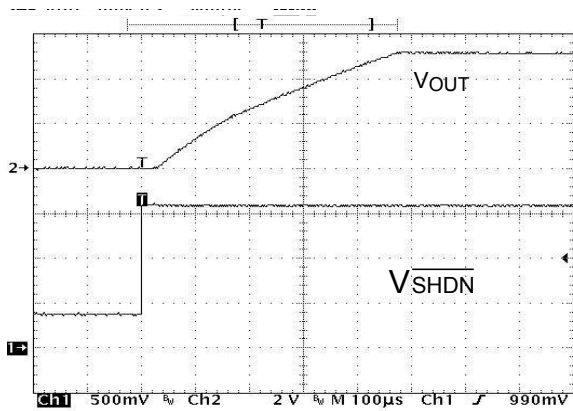

Fig. 17 Start-Up Time

$V_{IN}=3.0V, I_{OUT}=0A, C_{OUT}=10\mu F$

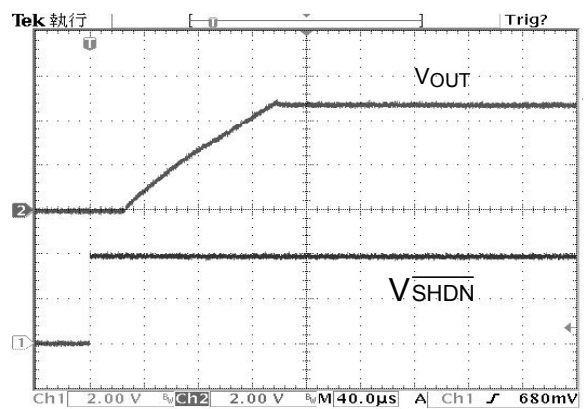
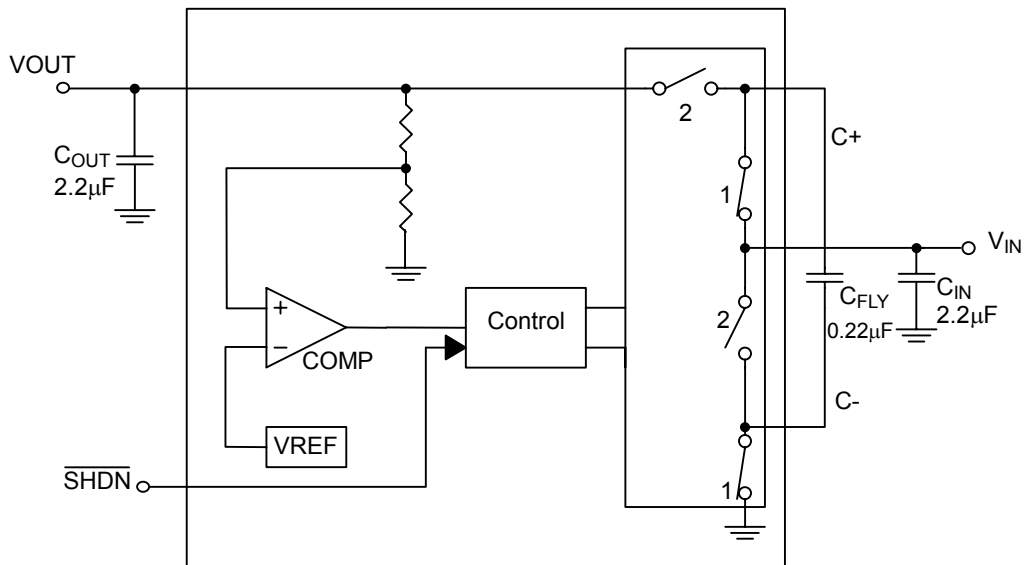

Fig. 18 Start-Up Time

$V_{IN}=3.0V, I_{OUT}=0A, C_{OUT}=2.2\mu F$

■ BLOCK DIAGRAM



■ PIN DESCRIPTIONS

- PIN 1: VOUT - Regulated output voltage. For the best performance, V_{OUT} should be bypassed with a 2.2µF (min) low ESR capacitor with the shortest distance in between.
- PIN 2: GND - Ground. Should be tied to a ground plane for best performance.
- PIN 3: $\overline{\text{SHDN}}$ - Active low shutdown input. A low voltage on $\overline{\text{SHDN}}$ disables the

AIC1845. $\overline{\text{SHDN}}$ is not allowed to float.

- PIN 4: C- - Flying capacitor negative terminal.
- PIN 5: VIN - Input supply voltage. V_{IN} should be bypassed with a 2.2µF (min) low ESR capacitor.
- PIN 6: C+ - Flying capacitor positive terminal.

■ APPLICATION INFORMATION

Introduction

AIC1845 is a micropower charge pump DC/DC converter that produces a regulated 5V output with an input voltage range from 2.7V to 5.0V. It utilizes the charge pump topology to boost V_{IN} to a regulated output voltage. Regulation is obtained by sensing the output voltage through an internal resistor divider. A switched doubling circuit enables the charge pump when the feedback voltage is lower than the trip point of the internal comparator, and vice versa. When the charge pump is enabled, a two-phase non-overlapping clock activates the charge pump switches. To maximize battery life for a battery-used application, quiescent current is limited up to 13 μ A.

Operation

This kind of converter uses capacitors to store and transfer energy. Since the capacitors can't change their voltage level abruptly, the voltage ratio of V_{OUT} over V_{IN} is limited to some range. Capacitive voltage conversion is obtained by switching a capacitor periodically. It first charges the capacitor by connecting it across a voltage source and then connects it to the output. Referring to Fig. 19, during the on state of internal clock, Q_1 and Q_4 are closed, which charges C_1 to V_{IN} level. During the off state, Q_3 and Q_2 are closed. The output voltage is V_{IN} plus V_{C1} , that is, $2V_{IN}$.

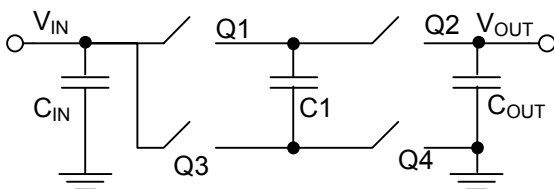

Fig. 19 The circuit of charge pump

Short Circuit/Thermal Protection

AIC1845 owns a built-in short circuit current limiting as well as an over temperature protection. During the short circuit condition, the output current is automatically constrained at approximately 170mA. This short circuit current will cause a rise in the internal IC junction temperature. When the die temperature exceeds 150°C, the thermal protection will shut the charge pump switching operation down and the die temperature will reduce afterwards. Once the die temperature drops below 135°C, the charge pump switching circuit will re-start. If the fault doesn't eliminate, the above protecting operation will repeat again and again. It allows AIC1845 to continuously work at short circuit condition without damaging the device.

Shutdown

In shutdown mode, the output is disconnected from input. The input current gets extremely low since most of the circuitry is turned off. Due to high impedance, shutdown pin can't be floated.

Efficiency

Referring to Fig. 20 and Fig. 21 here shows the circuit of charge pump at different states of operation. R_{DS-ON} is the resistance of the switching element at conduction. ESR is the equivalent series resistance of the flying capacitor C_1 . I_{ON-AVE} and $I_{OFF-AVE}$ are the average current during on state and off state, respectively. D is the duty cycle, which means the proportion the on state takes. Let's take advantage of conservation of charge for capacitor C_1 . Assume that the capacitor C_1 has reached its steady state. The amount of charge flowing into C_1 during on state is equal to that flowing out of C_1 at off state.

$$I_{ON-AVE} \times DT = I_{OFF-AVE} \times (1-D)T \dots\dots(1)$$

$$I_{ON-AVE} \times D = I_{OFF-AVE} \times (1-D) \dots\dots(2)$$

$$\begin{aligned} I_{IN} &= I_{ON-AVE} \times D + I_{OFF-AVE} \times (1-D) \\ &= 2 \times I_{ON-AVE} \times D \quad \dots\dots(3) \\ &= 2 \times I_{OFF-AVE} \times (1-D) \end{aligned}$$

$$I_{OUT} = I_{OFF-AVE} \times (1-D)$$

$$I_{IN} = 2I_{OUT}$$

For AIC1845, the controller takes the PSM (Pulse Skipping Modulation) control strategy. When the duty cycle is limited to 0.5, there will be:

$$I_{ON-AVE} \times 0.5 \times T = I_{OFF-AVE} \times (1-0.5) \times T$$

$$I_{ON-AVE} = I_{OFF-AVE}$$

According to the equation (4), we know that as long as the flying capacitor C1 is at steady state, the input current is twice the output current. The efficiency of charge pump is given below:

$$\eta = \frac{V_{OUT} \times I_{OUT}}{V_{IN} \times I_{IN}} = \frac{V_{OUT} \times I_{OUT}}{V_{IN} \times 2I_{OUT}} = \frac{V_{OUT}}{2V_{IN}}$$

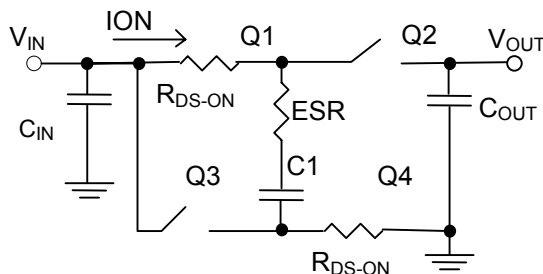

Fig. 20 The on state of charge pump circuit

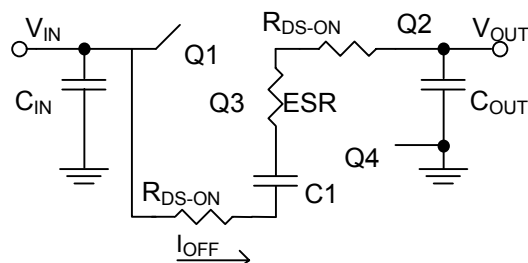

Fig. 21 The off state of charge pump circuit

External Capacitor Selection

Three external capacitors, CIN, COUT and CFLY, determine AIC1845 performances, in the aspects of output ripple voltage, charge pump strength and transient. Optimum performance can be obtained by the use of ceramic capacitors with low ESR. Due to high ESR, capacitors of tantalum and aluminum are not recommended for charge pump application.

To reduce noise and ripple, a low ESR ceramic capacitor, ranging from 2.2μF to 10μF, is recommended for CIN and COUT. The value of COUT determines the amount of output ripple voltage. An output capacitor with larger value results in smaller ripple.(5)

CFLY is critical for the strength of charge pump. The larger CFLY is, the larger output current and smaller ripple voltage obtain. However, large CIN and COUT are expected when a large CFLY applies. The ratio of CIN (as well as COUT) to CFLY should be approximately 10:1.

The value of capacitors, which is used under operation condition, determines the performance of a charge pump converter. And two factors, as follows, affect the capacitance of capacitor.

1. **Material:** Ceramic capacitors of different materials, such as X7R, X5R, Z5U and Y5V, have different tolerance in temperature and different capacitance loss. For example, a X7R or X5R type of capacitor can retain most of the capacitance at temperature from -40°C to 85°C, but a Z5U or Y5V type will lose most of the capacitance at that temperature range.

2. **Package Size:** A ceramic capacitor with large volume (0805), gets a lower ESR than a small one (0603). Therefore, large devices can improve more transient response than small ones.

Table 1 lists the recommended components for AIC1845 application.

Table.1 Bill of Material

Designator	Part Type	Description	Vendor	Phone
C _{IN}	2.2μ	CELMK212BJ-225MG (X5R)	TAIYO YUDEN	(02) 27972155~9
C _{FLY}	0.22μ	CEEMK212BJ-224KG (X7R)	TAIYO YUDEN	(02) 27972155~9
C _{OUT}	2.2μ	CELMK212BJ-225MG (X5R)	TAIYO YUDEN	(02) 27972155~9

Power Dissipation

Let's consider the power dissipation of R_{DS-ON} and ESR. Assume that the R_{DS-ON} of each internal switching element in AIC1845 is equal and ESR is the equivalent series resistance of C_{FLY} (ref to Fig. 20 and Fig. 21). The approximation of the power loss of R_{DS-ON} and ESR are given below:

$$\begin{aligned}
 P_{R_{DS-ON}} &\cong I_{ON-AVE}^2 \times 2R_{DS-ON} \times D + I_{OFF-AVE}^2 \times 2R_{DS-ON} \times (1-D) \\
 &= \left(\frac{I_{IN}}{2D}\right)^2 \times 2R_{DS-ON} \times D + \left(\frac{I_{OUT}}{1-D}\right)^2 \times 2R_{DS-ON} \times (1-D) \\
 &= \left(\frac{2I_{OUT}}{2D}\right)^2 \times 2R_{DS-ON} \times D + \left(\frac{I_{OUT}}{1-D}\right)^2 \times 2R_{DS-ON} \times (1-D) \\
 &= I_{OUT}^2 \times \left(\frac{2}{D} R_{DS-ON}\right) + I_{OUT}^2 \times \left(\frac{2}{1-D} R_{DS-ON}\right) \\
 &= I_{OUT}^2 \times \frac{2}{D(1-D)} \times R_{DS-ON}
 \end{aligned}$$

$$\begin{aligned}
 P_{ESR} &\cong I_{ON-AVE}^2 \times ESR \times D + I_{OFF-AVE}^2 \times ESR \times (1-D) \\
 &= \left(\frac{I_{IN}}{2D}\right)^2 \times ESR \times D + \left(\frac{I_{OUT}}{1-D}\right)^2 \times ESR \times (1-D) \\
 &= I_{OUT}^2 \times ESR \times \frac{1}{D} + I_{OUT}^2 \times ESR \times \frac{1}{1-D} \\
 &= I_{OUT}^2 \times ESR \times \frac{1}{D(1-D)}
 \end{aligned}$$

When the duty cycle is 0.5, the power loss of

switching element is

$$\begin{aligned}
 P_{R_{DS-ON}} &\cong I_{OUT}^2 \times \frac{2}{0.5(1-0.5)} \times R_{DS-ON} \\
 &= I_{OUT}^2 \times 8R_{DS-ON}
 \end{aligned}$$

$$\begin{aligned}
 P_{ESR} &\cong I_{OUT}^2 \times ESR \times \frac{1}{0.5(1-0.5)} \\
 &= I_{OUT}^2 \times 4ESR
 \end{aligned}$$

In fact, no matter the current is at on state or off state, it decays exponentially rather than flows steadily. And the root mean square value of exponential decay is not equal to that of steady flow. That is why the approximation comes from.

Let's treat the charge pump circuit in another approach and lay the focus on the flying capacitor C₁. Referring to Fig. 20, when the circuit is at the on state, the voltage across C₁ is:

$$V_{C-ON}(t) = V_{IN} - 2R_{DS-ON} \times I_{ON}(t) - ESR \times I_{ON}(t) \dots(9)$$

The average of V_{C1} during the on state is:

$$V_{C-ON-AVE} = V_{IN} - 2R_{DS-ON} \times I_{ON-AVE} - ESR \times I_{ON-AVE} \dots(10)$$

Similarly, referring to Fig. 21, when the circuit is at the off state, the voltage of C₁ is:

$$\begin{aligned}
 V_{C-OFF}(t) &= \\
 &V_{OUT} - V_{IN} + 2R_{DS-ON} \times I_{OFF}(t) + ESR \times I_{OFF}(t) \\
 &\dots\dots\dots(11)
 \end{aligned}$$

The average of V_{C1} during the off state is:

$$\begin{aligned}
 V_{C-OFF-AVE} &= \\
 &V_{OUT} - V_{IN} + 2R_{DS-ON} \times I_{OFF-AVE} + ESR \times I_{OFF-AVE} \\
 &\dots\dots\dots(12)
 \end{aligned}$$

The difference of charge stored in C₁ between on state and off state is the net charge transferred to the output in one cycle.

$$\begin{aligned}
 \Delta Q &= Q_{ON} - Q_{OFF} \\
 &= C_1 \times (V_{C1-ON-AVE} - V_{C1-OFF-AVE}) \\
 &= C_1 \times (2V_{IN} - V_{OUT} - 2R_{DS-ON} \times I_{ON-AVE} - 2R_{DS-ON} \times I_{OFF-AVE} - ESR \times I_{ON-AVE} - ESR \times I_{OFF-AVE}) \dots\dots\dots(13) \\
 &= C_1 \times (2V_{IN} - V_{OUT} - 2R_{DS-ON} \times \frac{I_{OUT}}{D} - 2R_{DS-ON} \times \frac{I_{OUT}}{1-D} - ESR \times \frac{I_{OUT}}{D} - ESR \times \frac{I_{OUT}}{1-D}) \\
 &= C_1 \times [2V_{IN} - V_{OUT} - (2R_{DS-ON} + ESR) \times I_{OUT} \times \frac{1}{D(1-D)}]
 \end{aligned}$$

Thus the output current can be written as

$$\begin{aligned}
 I_{OUT} &= f \times \Delta Q = f \times (Q_{ON} - Q_{OFF}) \\
 &= f \times C_1 \times [2V_{IN} - V_{OUT} - (2R_{DS-ON} + ESR) \times I_{OUT} \times \frac{1}{D(1-D)}] \dots\dots\dots(14)
 \end{aligned}$$

When the duty cycle is 0.5, the output current can be written as:

$$\begin{aligned}
 I_{OUT} &= f \times C_1 \times [2V_{IN} - V_{OUT} - (2R_{DS-ON} + ESR) \times I_{OUT} \times \frac{1}{0.5(1-0.5)}] \dots\dots\dots(15) \\
 &= fC_1 \times [2V_{IN} - V_{OUT} - (8R_{DS-ON} + 4ESR) \times I_{OUT}]
 \end{aligned}$$

And equation (15) can be re-written as:

$$2V_{IN} - V_{OUT} = \frac{1}{fC_1} \times I_{OUT} + (8R_{DS-ON} + 4ESR) \times I_{OUT} \dots\dots\dots(16)$$

According the equation (16), when the duty cycle is 0.5, the equivalent circuit of charge pump is shown in Fig. 22. The term $8R_{DS-ON}$ is the total effect of switching resistance, $1/fC_1$ is the effect of flying capacitor and $4ESR$ is its equivalent resistance.

From the equivalent circuit shown in Fig. 22, it is seen that the terms $1/fC_1$, $4ESR$ and $8R_{DS-ON}$ should be as small as possible to get large output current. However, for users, since the R_{DS-ON} is fixed and manufactured in IC, what we can do is to lower $1/fC_1$ and ESR . However even the effect of $1/fC_1$ and ESR can be kept as small as possible, the term $8R_{DS-ON}$ still dominates the role that limits the maximum output current.

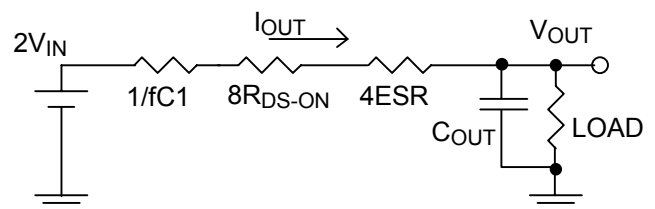

Fig. 22 The equivalent circuit of charge pump

Layout Considerations

Due to the switching frequency and high transient current of AIC1845, careful consideration of PCB layout is necessary. To achieve the best performance of AIC1845, minimize the distance between every two components and also minimize every connection length with a maximum trace width. Make sure each device connects to immediate ground plane. Fig. 23 to Fig. 25 show the recommended layout.

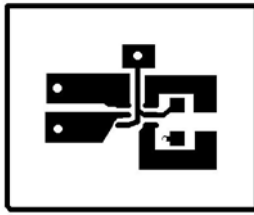

Fig. 23 Top layer

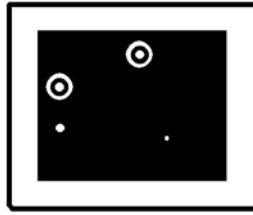

Fig. 24 Bottom layer

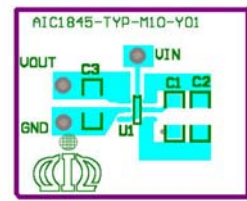
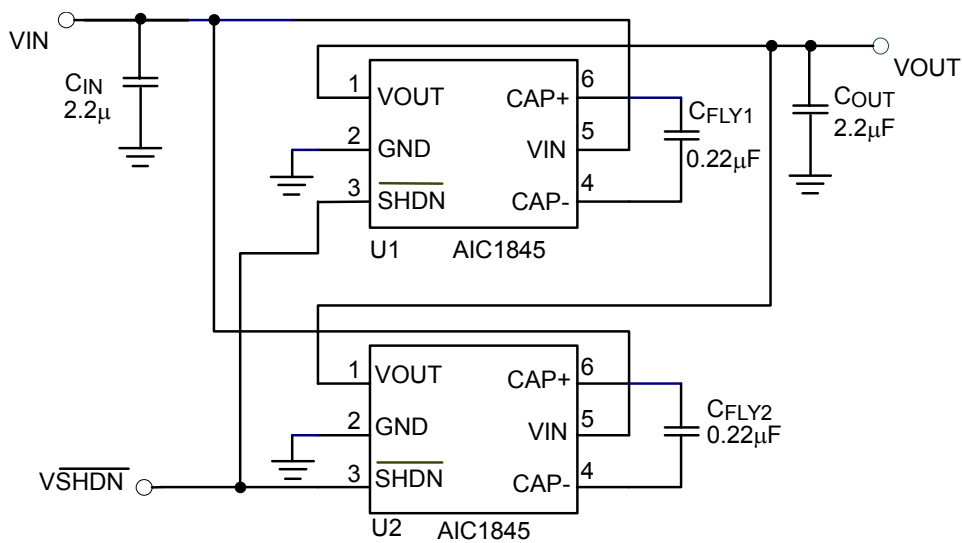

Fig. 25 Topover layer

APPLICATION EXAMPLES



C_{IN} , C_{OUT} : TAIYO YUDEN Ceramic Capacitor, CELMK212BJ225MG (X5R) (0805)
 C_{FLY1} , C_{FLY2} : TAIYO YUDEN Ceramic Capacitor, CEEMK212BJ224KG (X7R) (0805)

Fig. 26 Parallel Two AIC1845 to Obtain the Regulated 5V Output with large output current.

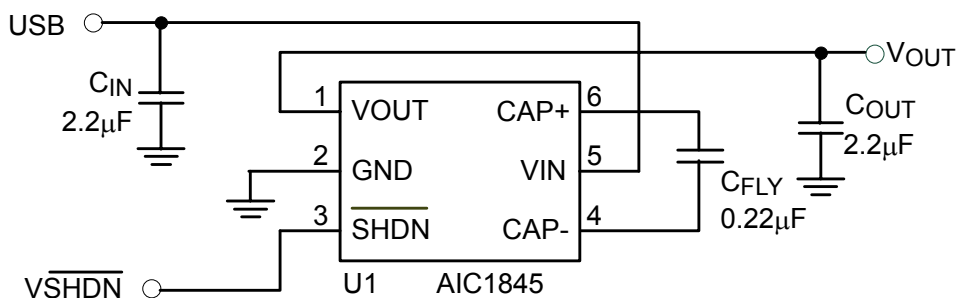

C_{IN} , C_{OUT} : TAIYO YUDEN Ceramic Capacitor, CELMK212BJ225MG (X5R) (0805)
 C_{FLY1} : TAIYO YUDEN Ceramic Capacitor, CEEMK212BJ224KG (X7R) (0805)

Fig. 27 Regulated 5V from USB

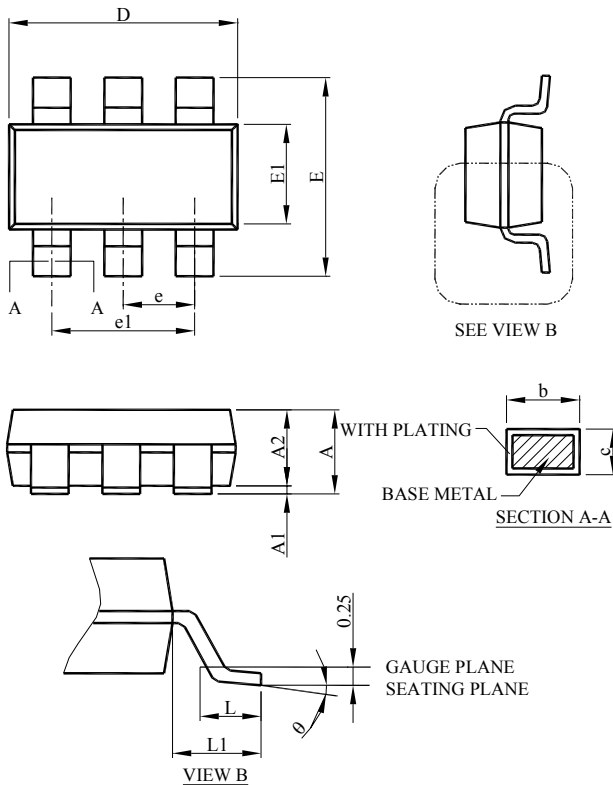
PHYSICAL DIMENSIONS (unit: mm)
SOT-23-6

SOT-26		
MILLIMETERS		
SYMBOL	MIN.	MAX.
A	0.95	1.45
A1	0.05	0.15
A2	0.90	1.30
b	0.30	0.50
c	0.08	0.22
D	2.80	3.00
E	2.60	3.00
E1	1.50	1.70
e	0.95 BSC	
e1	1.90 BSC	
L	0.30	0.60
L1	0.60 REF	
θ	0°	8°

Note:

Information provided by AIC is believed to be accurate and reliable. However, we cannot assume responsibility for use of any circuitry other than circuitry entirely embodied in an AIC product; nor for any infringement of patents or other rights of third parties that may result from its use. We reserve the right to change the circuitry and specifications without notice.

Life Support Policy: AIC does not authorize any AIC product for use in life support devices and/or systems. Life support devices or systems are devices or systems which, (i) are intended for surgical implant into the body or (ii) support or sustain life, and whose failure to perform, when properly used in accordance with instructions for use provided in the labeling, can be reasonably expected to result in a significant injury to the user.