

SPECIFICATION

Device Name : Power Integrated Module

Type Name : 7MBR20SA060A

Spec. No. : MS6M 0430

This material and the information herein is the property of Fuji Electric Co., Ltd. They shall be neither reproduced, copied, lent, or disclosed in any way whatsoever for the use of any third party nor used for the manufacturing purposes without the express written consent of Fuji Electric Co., Ltd.

Fuji Electric Co., Ltd.
Matsumoto Factory

	DATE	NAME	APPROVED	Fuji Electric Co., Ltd.	
DRAWN	May-20-99	T. Sakata	T. Miyasaka	DWG. NO.	MS6M 0430
CHECKED	May-27-99	S. Muroga			

Revised Records

Date	Classi- fication	Ind.	Content	Applied date	Drawn	Checked	Approved
May 20-'99	enactment	—	—————	Issued date	—	N. Miyata	T. Miyasaka

This material and the information herein is the property of Fuji Electric Co., Ltd. They shall be neither reproduced, copied, lent, or disclosed in any way whatsoever for the use of any third party nor used for the manufacturing purposes without the express written consent of Fuji Electric Co., Ltd.

Fuji Electric Co., Ltd.

DWG. NO.

MS6M 0430

2 / 10

7MBR20SA060A

1. Outline Drawing (Unit : mm)

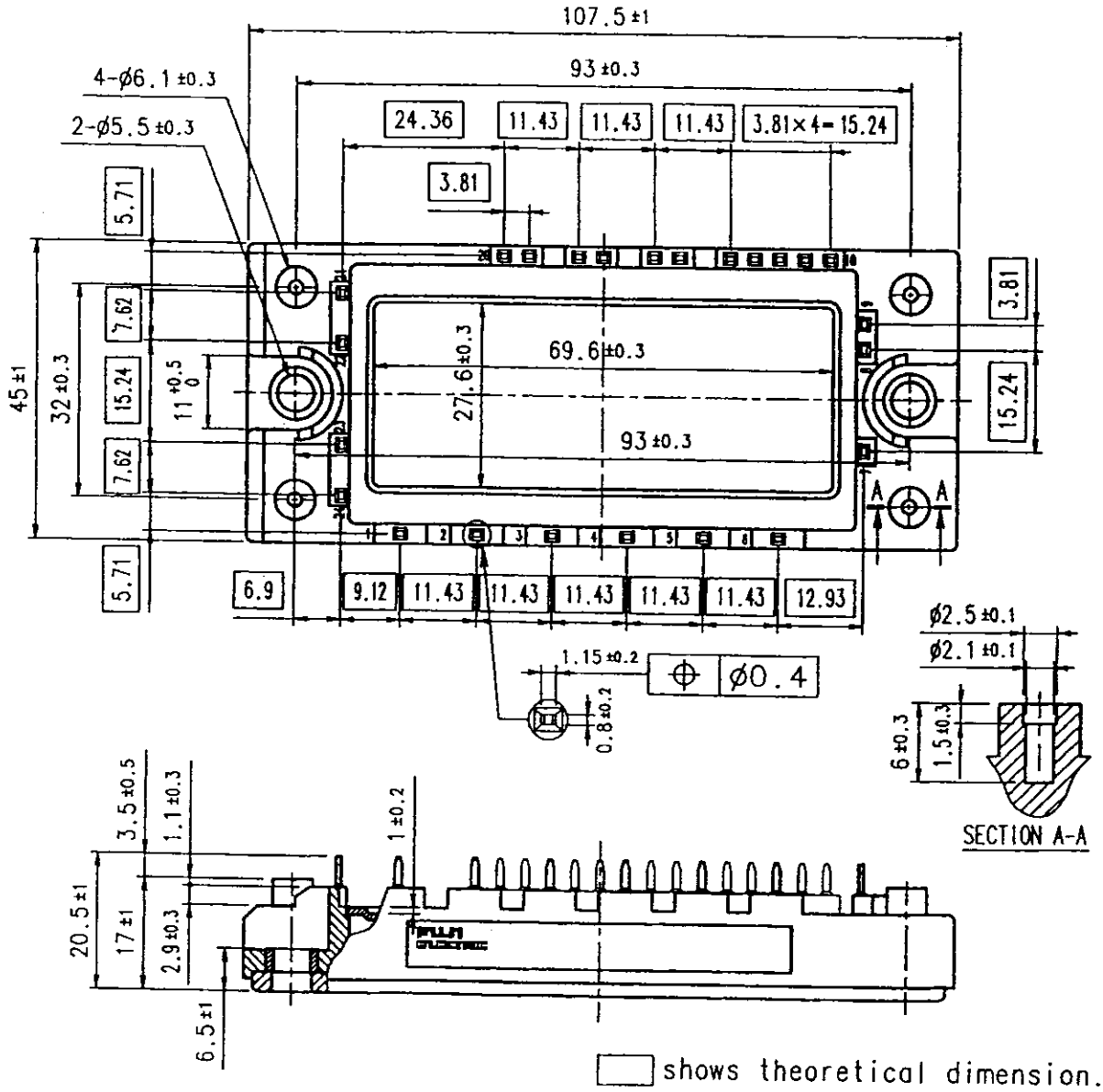

This material and the information herein is the property of Fuji Electric Co. Ltd. They shall be neither reproduced, copied, lent, or disclosed in any way whatsoever for the use of any third party nor used for the manufacturing purposes without the express written consent of Fuji Electric Co., Ltd.

2. Equivalent circuit

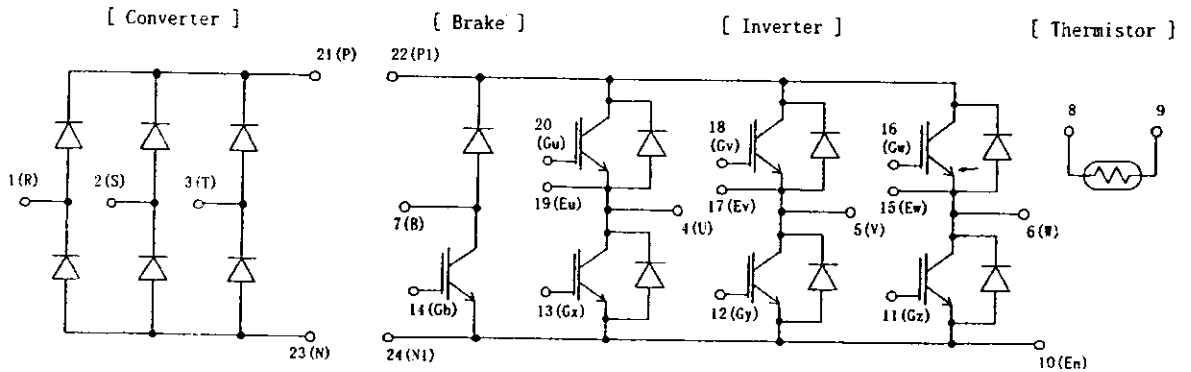

Fuji Electric Co., Ltd.

DWG. NO.

MS6M 0430

3 / 10

3. Absolute Maximum Ratings (at Tc= 25°C unless otherwise specified)

Items		Symbols	Conditions	Maximum Ratings	Units
Inverter	Collector-Emitter voltage	VCES		600	V
	Gate-Emitter voltage	VGES		±20	V
	Collector current	Ic	Continuous	20	A
		Icp	1ms	40	A
		-Ic		20	A
Collector Power Dissipation	Pc	1 device	80	W	
Brake	Collector-Emitter voltage	VCES		600	V
	Gate-Emitter voltage	VGES		±20	V
	Collector current	Ic	Continuous	20	A
		Icp	1ms	40	A
	Collector Power Dissipation	Pc	1 device	50	W
Converter	Repetitive peak reverse Voltage(Diode)	VRRM		600	V
	Repetitive peak reverse Voltage	VRRM		800	V
	Average Output Current	Io	50Hz/60Hz sine wave	20	A
	Surge Current (Non-Repetitive)	IFSM	Tj=150°C, 10ms	210	A
	I ² t (Non-Repetitive)	I ² t	half sine wave	221	A ² s
Junction temperature	Tj		150	°C	
Storage temperature	Tstg		-40~ +125	°C	
Isolation voltage	between terminal and copper base ^(*1)	Viso	AC : 1min.	2500	V
	between thermistor and others ^(*2)			2500	V
Mounting Screw Torque ^(*3)				3.5	N·m

(*1) All terminals should be connected together when isolation test will be done.

(*2) Terminal 8 and 9 should be connected together. Terminal 1 to 7 and 10 to 24 should be connected together and shorted to copper base.

(*3) Recommendable Value : 2.5~3.5 N·m (M5)

This material and the information herein is the property of Fuji Electric Co. Ltd. They shall be neither reproduced, copied, lent, or disclosed in any way whatsoever for the use of any third party nor used for the manufacturing purposes without the express written consent of Fuji Electric Co. Ltd.

4: Electrical characteristics (at Tj= 25°C unless otherwise specified)

Items	Symbols	Conditions	Characteristics			Units		
			min.	typ.	Max.			
Inverter	Zero gate voltage Collector current	ICES	VGE = 0 V, VCE = 600 V			1.0	mA	
	Gate-Emitter leakage current	IGES	VCE = 0 V, VGE = ±20 V			200	nA	
	Gate-Emitter threshold voltage	VGE(th)	VCE = 20 V, Ic = 20 mA	5.5	7.8	8.5	V	
	Collector-Emitter saturation voltage	VCE(sat)	VGE = 15 V, chip		1.8			V
			Ic = 20 A terminal		1.95	2.4		
	Input capacitance	Cies	VGE = 0 V, VCE = 10 V f = 1 MHz		3000			pF
	Turn-on time	ton	Vcc = 300 V		0.45	1.2		μs
		tr	Ic = 20 A		0.25	0.6		
		tr(1)	VGE = ±15 V		0.08			
	Turn-off time	toff	RG = 82 Ω		0.40	1.0		μs
tf				0.05	0.35			
Forward on voltage	VF	IF = 20 A	chip		1.8		V	
			terminal		1.95	2.6		
Reverse recovery time	trr	IF = 20 A				300	ns	
Brake	Zero gate voltage Collector current	ICES	VGE = 0 V, VCE = 600 V			1.0	mA	
	Gate-Emitter leakage current	IGES	VCE = 0 V, VGE = ±20 V			200	nA	
	Collector-Emitter saturation voltage	VCE(sat)	VGE = 15 V, chip		1.8			V
			Ic = 20 A terminal		1.95	2.4		
	Turn-on time	ton	Vcc = 300 V		0.45	1.2		μs
		tr	Ic = 20 A		0.25	0.6		
		toff	VGE = ±15 V		0.40	1.0		
Turn-off time	tf	RG = 120 Ω		0.05	0.35			
	IRRM	VR = 600 V				1.0	mA	
Converter	VFM	IF = 20 A	chip		1.1		V	
			terminal		1.2	1.5		
Reverse current	IRRM	VR = 800 V				1.0	mA	
Thermistor	R	T = 25°C		5000			Ω	
		T = 100°C	465	495	520			
B value	B	T = 25/50°C	3305	3375	3450		K	

This material and the information herein is the property of
 Fuji Electric Co., Ltd. They shall be neither reproduced, copied
 nor disclosed in any way whatsoever for the use of any
 third party nor used for the manufacturing purposes without
 the express written consent of Fuji Electric Co., Ltd.

5. Thermal resistance characteristics

Items	Symbols	Conditions	Characteristics			Units
			min.	typ.	Max.	
Thermal resistance (1 device)	Rth(j-c)	Inverter IGBT			1.56	°C/W
		Inverter FWD			3.00	
		Brake IGBT			2.50	
		Converter Diode			2.00	
Contact Thermal resistance	Rth(c-f)	with Thermal Compound (*)		0.05		°C/W

※ This is the value which is defined mounting on the additional cooling fin with thermal compound.

6. Indication on module (モジュール表示)



7. Applicable category (適用範囲)

This specification is applied to Power Integrated Module named 7MBR20SA060A.
 本納入仕様書は パワー集積モジュール 7MBR20SA060A に適用する。

8. Storage and transportation notes (保管・運搬上の注意事項)

- The module should be stored at a standard temperature of 5 to 35°C and humidity of 45 to 75%.
 常温・常湿保存が望ましい。(5~35°C, 45~75%)
- Store modules in a place with few temperature changes in order to avoid condensation on the module surface.
 急激な温度変化のなきこと。(モジュール表面が結露しないこと)
- Avoid exposure to corrosive gases and dust.
 腐蝕性ガスの発生場所, 塵埃の多い場所は避けること。
- Avoid excessive external force on the module.
 製品に荷重がかからないように 十分注意すること。
- Store modules with unprocessed terminals.
 モジュールの端子は未加工の状態 で保管すること。
- Do not drop or otherwise shock the modules when transporting.
 製品の運搬時に衝撃を与えたり、落下させたりしないこと。

This material and the information herein is the property of Fuji Electric Co. Ltd. They shall be neither reproduced, copied, sent, or disclosed in any way whatsoever for the use of any third party nor used for the manufacturing purposes without the express written consent of Fuji Electric Co., Ltd.

9. Definitions of switching time (スイッチング時間の定義)

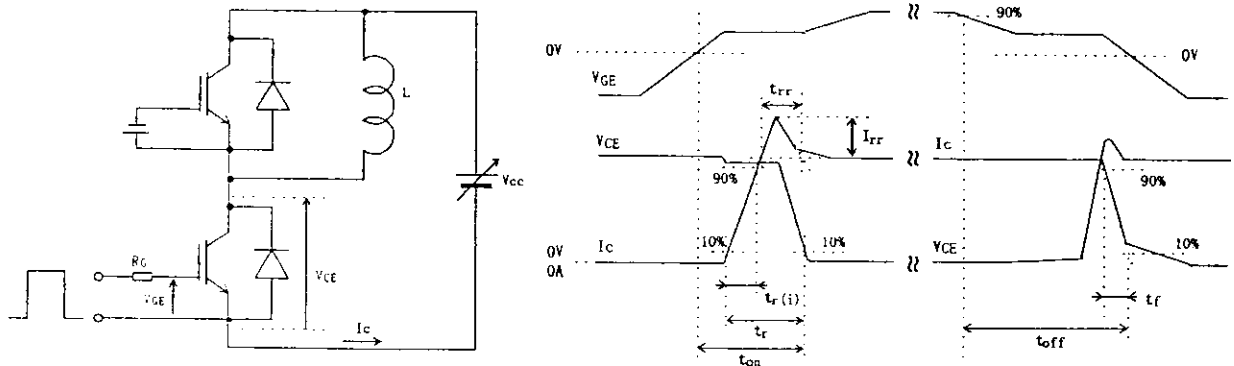

This material and the information herein is the property of Fuji Electric Co. Ltd. They shall be neither reproduced, copied, sent, or disclosed in any way whatsoever for the use of any third party nor used for the manufacturing purposes without the express written consent of Fuji Electric Co. Ltd.

[Inverter]
Collector current vs. Collector-Emitter voltage
 $T_j = 25^\circ\text{C}$ (typ.)

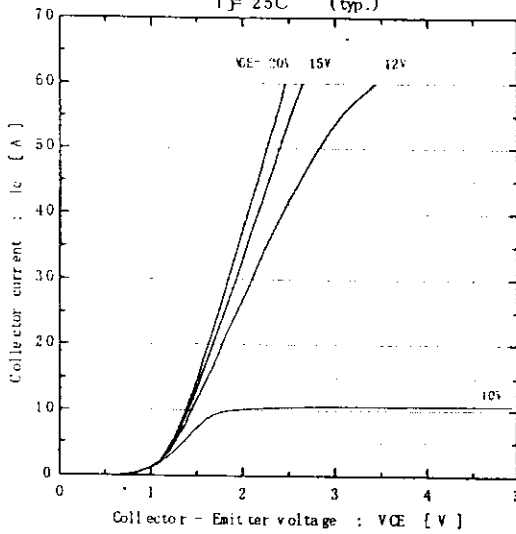

[Inverter]
Collector current vs. Collector-Emitter voltage
 $T_j = 125^\circ\text{C}$ (typ.)

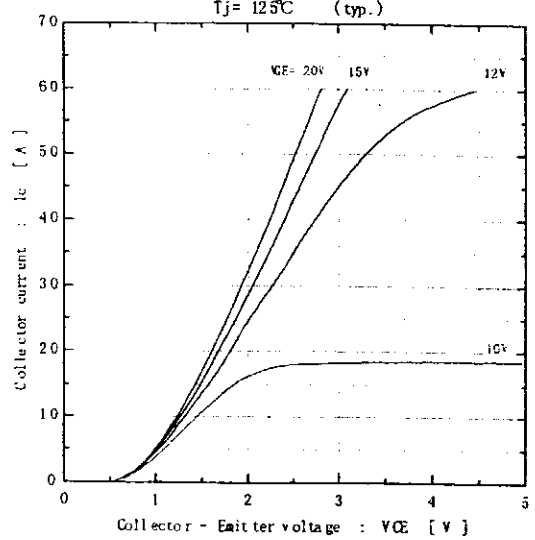

[Inverter]
Collector current vs. Collector-Emitter voltage
 $V_{GE} = 15\text{V}$ (typ.)

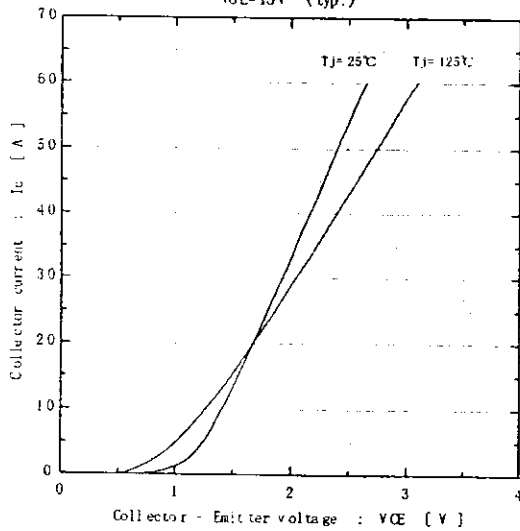

[Inverter]
Collector-Emitter voltage vs. Gate-Emitter voltage
 $T_j = 25^\circ\text{C}$ (typ.)

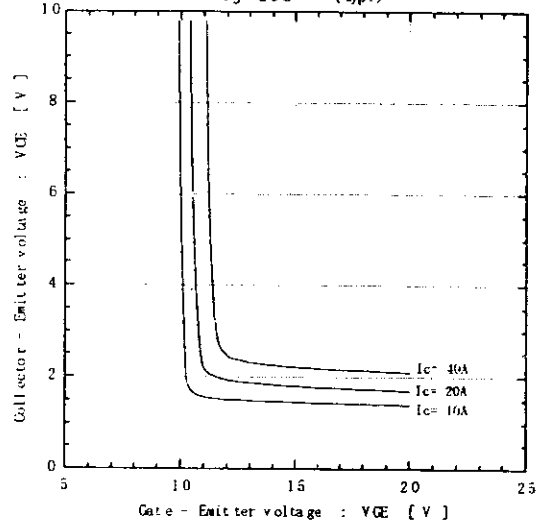

[Inverter]
Capacitance vs. Collector-Emitter voltage (typ.)
 $V_{GE} = 0\text{V}$, $f = 1\text{MHz}$, $T_j = 25^\circ\text{C}$

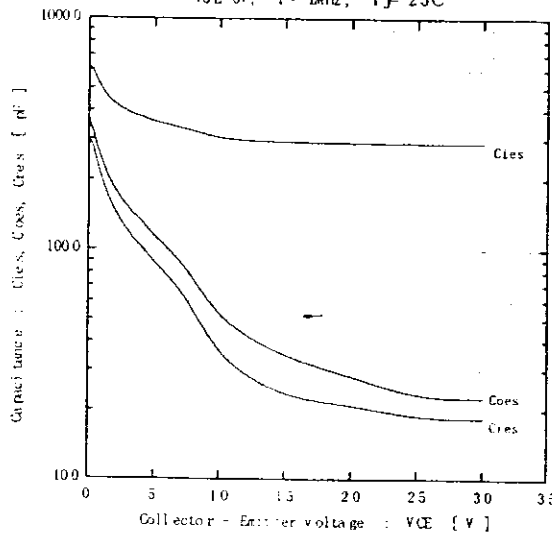

[Inverter]
Dynamic Gate charge (typ.)
 $V_{CC} = 300\text{V}$, $I_c = 20\text{A}$, $T_j = 25^\circ\text{C}$

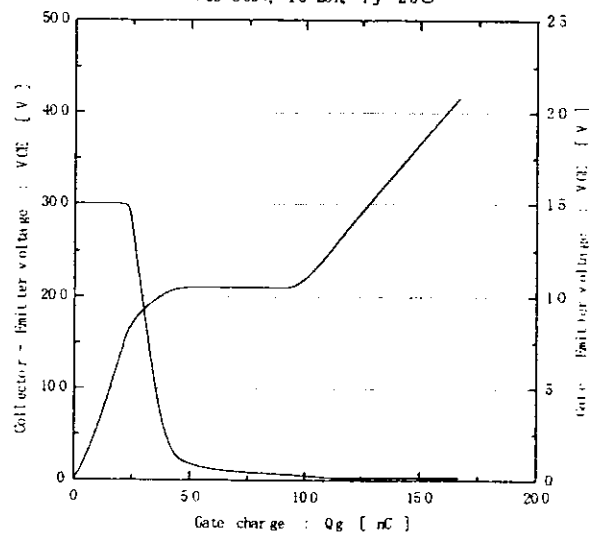

This material and the information herein is the property of Fuji Electric Co., Ltd. They shall be neither reproduced, copied, nor disclosed in any way whatsoever for the use of any third party, nor used for the manufacturing purposes without the express written consent of Fuji Electric Co., Ltd.

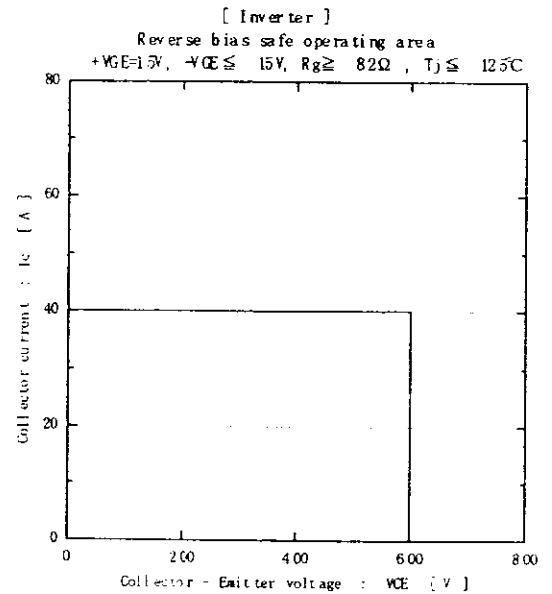
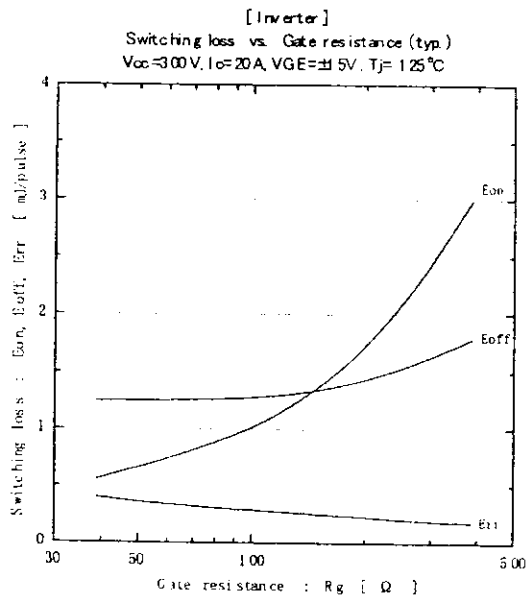
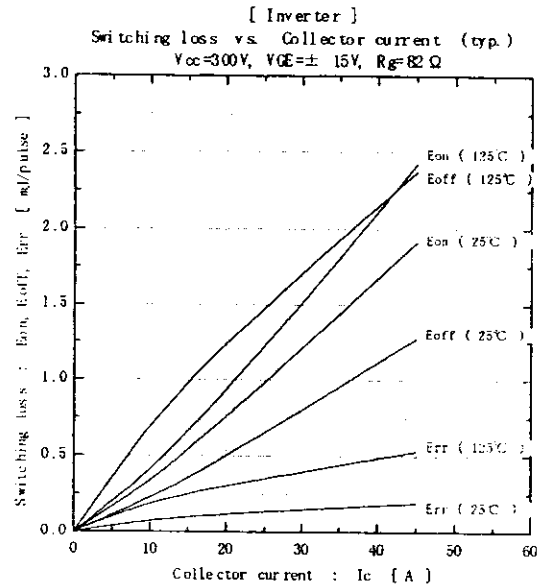
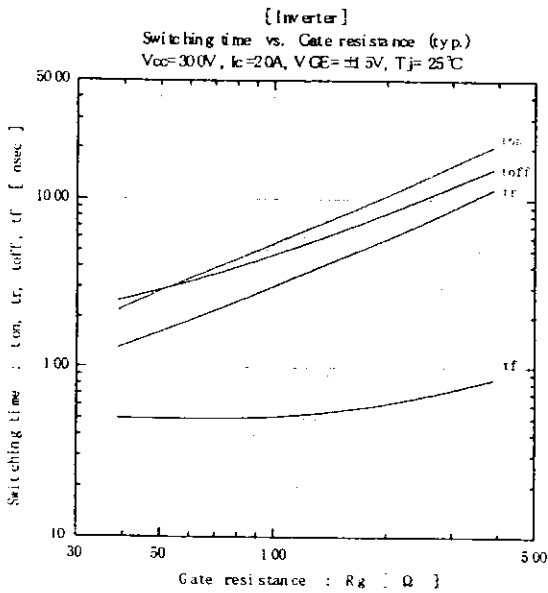
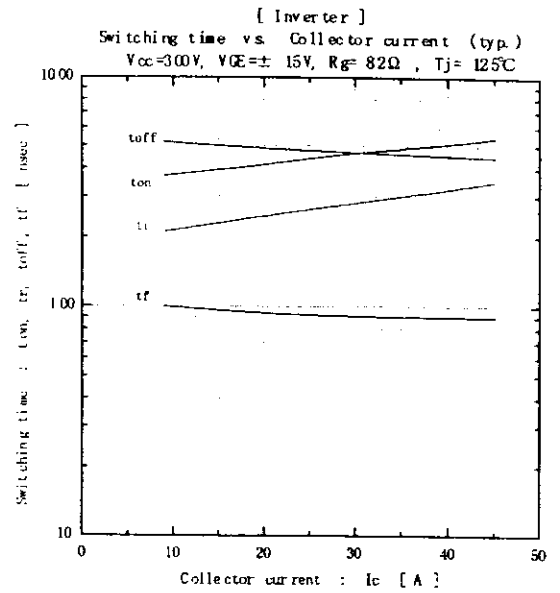
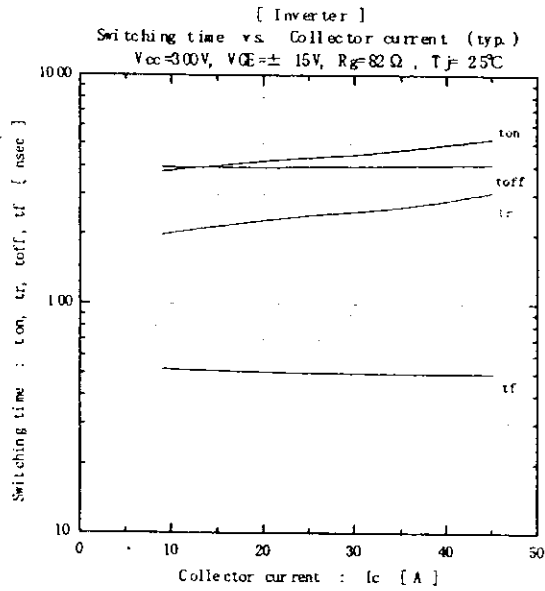

This material and the information herein is the property of Fuji Electric Co., Ltd. They shall be neither reproduced, copied, lent, or disclosed in any way whatsoever for the use of any third party nor used for the manufacturing purposes without the express written consent of Fuji Electric Co., Ltd.

[Inverter]
Forward current vs. Forward on voltage (typ.)

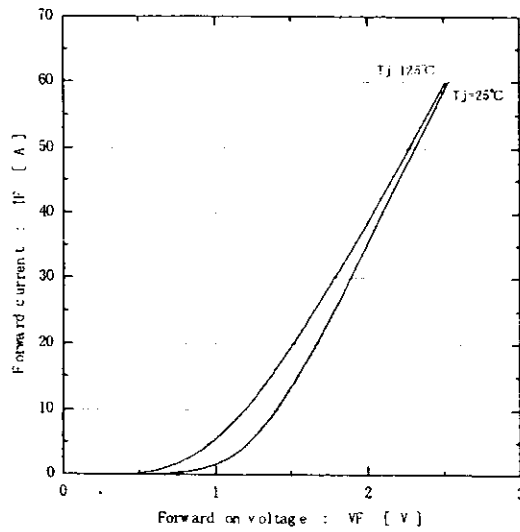

[Inverter]
Reverse recovery characteristics (typ.)
 $V_{CC} = 300V, V_{GE} = \pm 15V, R_g = 82 \Omega$

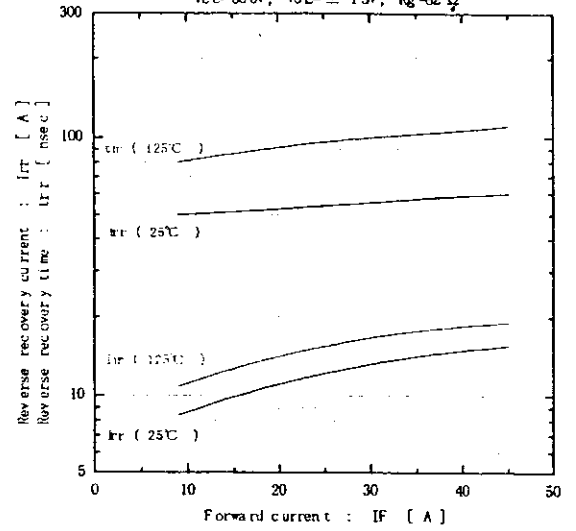

[Converter]
Forward current vs. Forward on voltage (typ.)

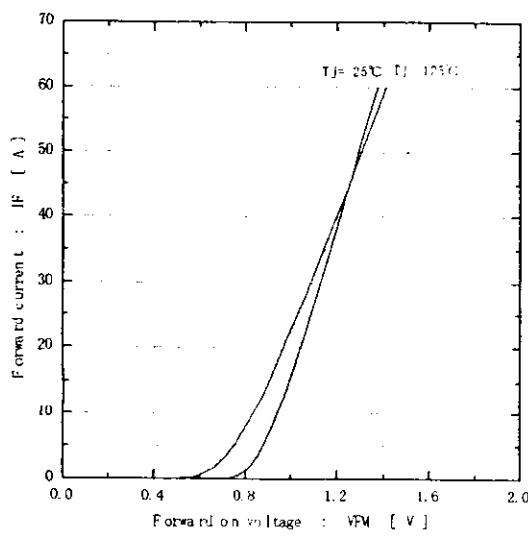

Transient thermal resistance

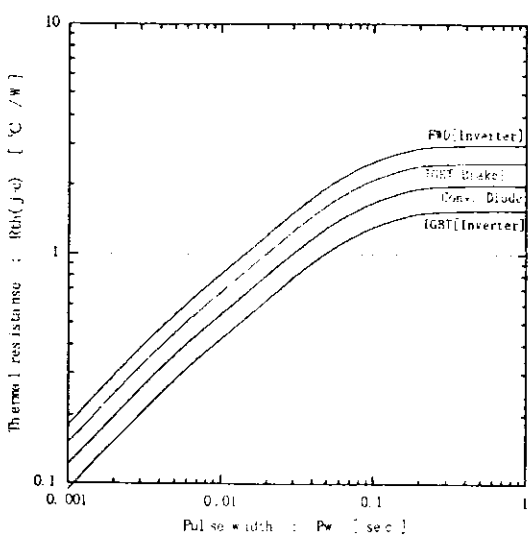

[Thermistor]
Temperature characteristic (typ.)

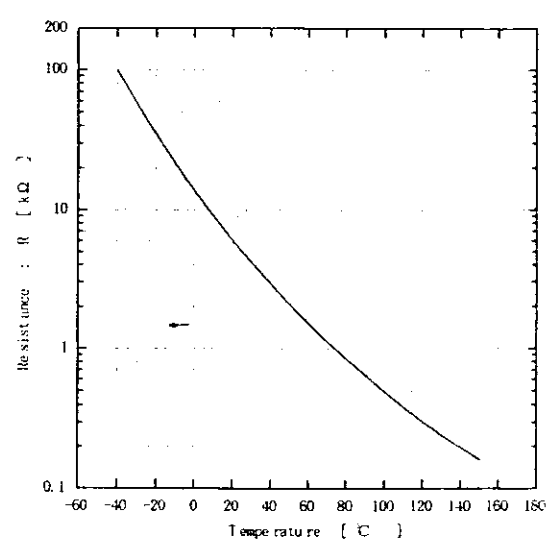

This material and the information herein is the property of Fuji Electric Co., Ltd. They shall be neither reproduced, copied, lent, or disclosed in any way whatsoever for the use of any third party nor used for the manufacturing purposes without the express written consent of Fuji Electric Co., Ltd.

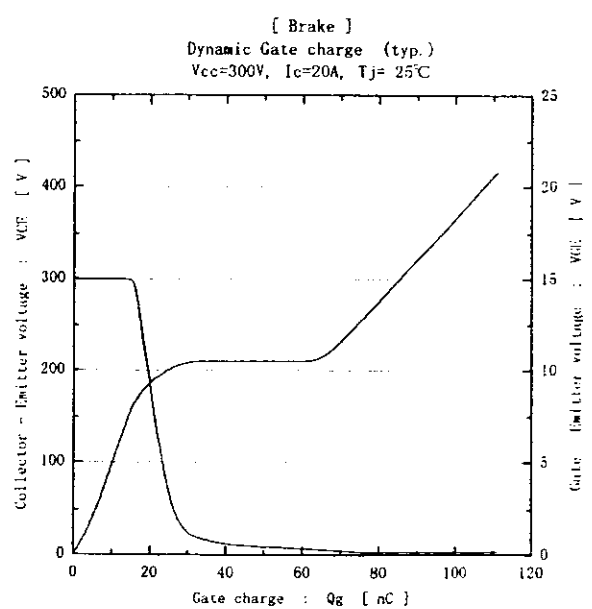
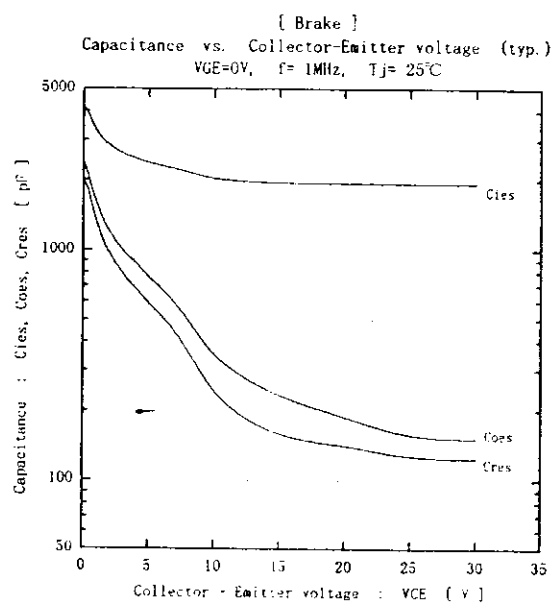
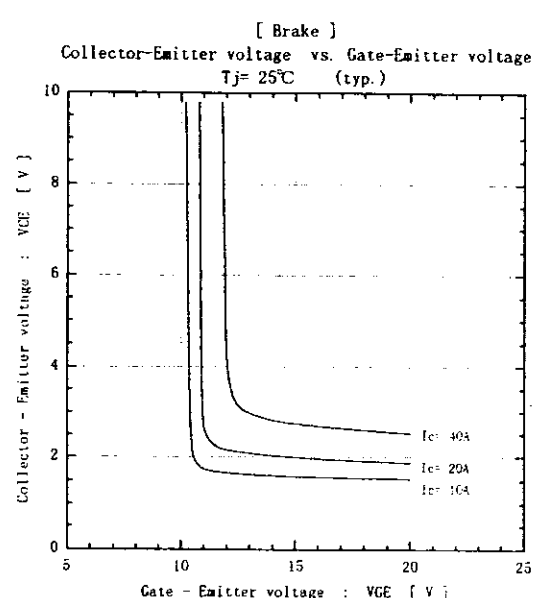
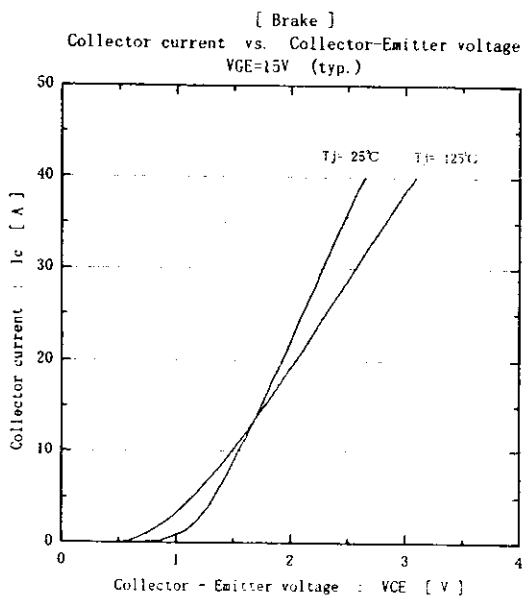
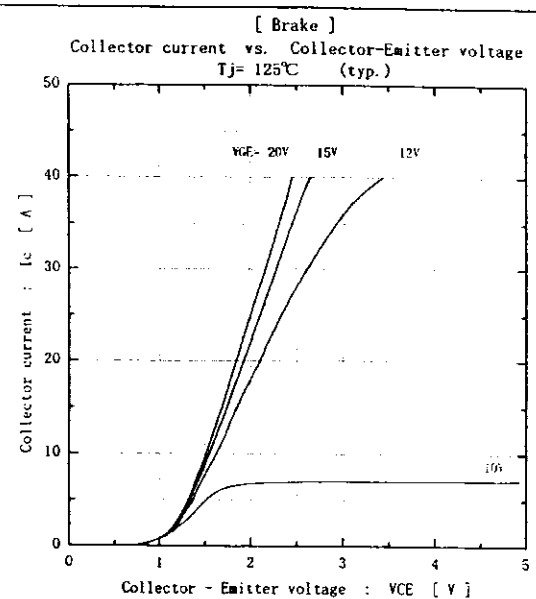
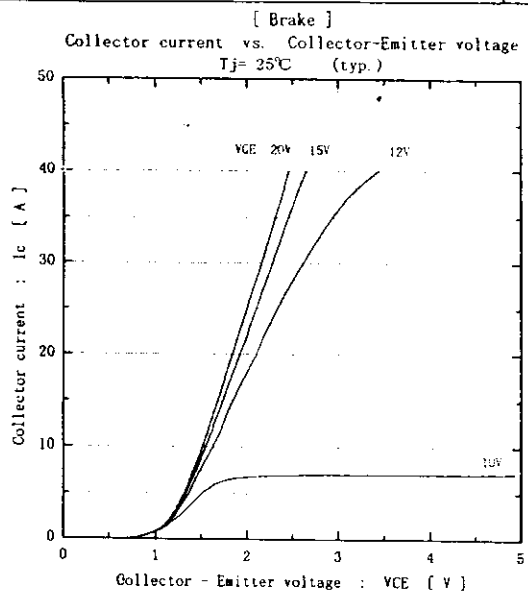

Fuji Electric Co., Ltd.

DWG.NO.

MS6M 0430

1/10

This datasheet has been download from:

www.datasheetcatalog.com

Datasheets for electronics components.