

TOSHIBA FIELD EFFECT TRANSISTOR SILICON N CHANNEL MOS TYPE (π -MOSIII)

2SK2733

HIGH SPEED, HIGH CURRENT SWITCHING APPLICATIONS
 CHOPPER REGULATOR, DC-DC CONVERTER AND MOTOR DRIVE APPLICATIONS

INDUSTRIAL APPLICATIONS
 Unit in mm

- Low Drain-Source ON Resistance : $R_{DS(ON)} = 8.0\Omega$ (Typ.)
- High Forward Transfer Admittance : $|Y_{fs}| = 0.9S$ (Typ.)
- Low Leakage Current : $I_{DSS} = 100\mu A$ (Max.) ($V_{DS} = 720V$)
- Enhancement-Mode : $V_{th} = 2.0 \sim 4.0V$ ($V_{DS} = 10V, I_D = 1mA$)

MAXIMUM RATINGS ($T_a = 25^\circ C$)

CHARACTERISTIC		SYMBOL	RATING	UNIT
Drain-Source Voltage		V_{DSS}	900	V
Drain-Gate Voltage ($R_{GS} = 20k\Omega$)		V_{DGR}	900	V
Gate-Source Voltage		V_{GSS}	± 30	V
Drain Current	DC	I_D	1	A
	Pulse	I_{DP}	3	
Drain Power Dissipation ($T_c = 25^\circ C$)		P_D	60	W
Single Pulse Avalanche Energy**		E_{AS}	324	mJ
Avalanche Current		I_{AR}	1	A
Repetitive Avalanche Energy*		E_{AR}	6.0	mJ
Channel Temperature		T_{ch}	150	$^\circ C$
Storage Temperature Range		T_{stg}	$-55 \sim 150$	$^\circ C$

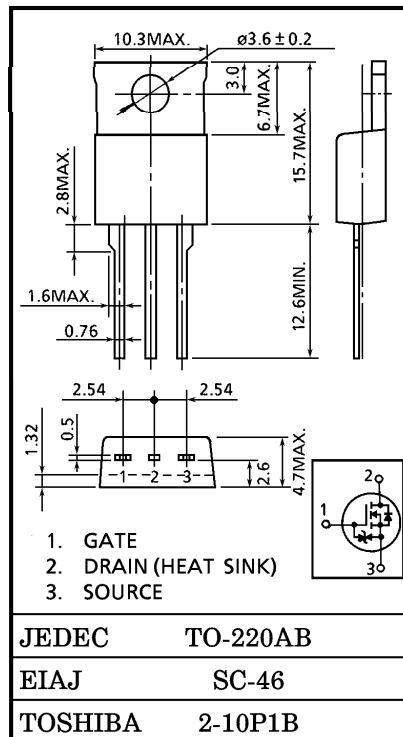

Weight : 2.0g

HERMAL CHARACTERISTICS

CHARACTERISTIC	SYMBOL	MAX.	UNIT
Thermal Resistance, Channel to Case	$R_{th(ch-c)}$	2.08	$^\circ C / W$
Thermal Resistance, Channel to Ambient	$R_{th(ch-a)}$	83.3	$^\circ C / W$

Note ;

* Repetitive rating ; Pulse Width Limited by Max. junction temperature.

** $V_{DD} = 90V$, Starting $T_{ch} = 25^\circ C$, $L = 594mH$, $R_G = 25\Omega$, $I_{AR} = 1A$

This transistor is an electrostatic sensitive device. Please handle with caution.

961001EAA2

● TOSHIBA is continually working to improve the quality and the reliability of its products. Nevertheless, semiconductor devices in general can malfunction or fail due to their inherent electrical sensitivity and vulnerability to physical stress. It is the responsibility of the buyer, when utilizing TOSHIBA products, to observe standards of safety, and to avoid situations in which a malfunction or failure of a TOSHIBA product could cause loss of human life, bodily injury or damage to property. In developing your designs, please ensure that TOSHIBA products are used within specified operating ranges as set forth in the most recent products specifications. Also, please keep in mind the precautions and conditions set forth in the TOSHIBA Semiconductor Reliability Handbook.

● The information contained herein is presented only as a guide for the applications of our products. No responsibility is assumed by TOSHIBA CORPORATION for any infringements of intellectual property or other rights of the third parties which may result from its use. No license is granted by implication or otherwise under any intellectual property or other rights of TOSHIBA CORPORATION or others.

● The information contained herein is subject to change without notice.

ELECTRICAL CHARACTERISTICS (Ta = 25°C)

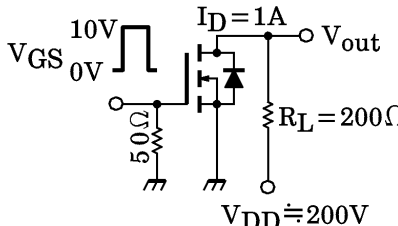
CHARACTERISTIC		SYMBOL	TEST CONDITION	MIN.	TYP.	MAX.	UNIT
Gate Leakage Current		IGSS	VGS = ±30V, VDS = 0V	—	—	±10	μA
Gate-Source Breakdown Voltage		V (BR) GSS	IG = ±10μA, VDS = 0V	±30	—	—	V
Drain Cut-off Current		IDSS	VDS = 720V, VGS = 0V	—	—	100	μA
Drain-Source Breakdown Voltage		V (BR) DSS	ID = 10mA, VGS = 0V	900	—	—	V
Gate Threshold Voltage		Vth	VDS = 10V, ID = 1mA	2.0	—	4.0	V
Drain-Source ON Resistance		RDS (ON)	VGS = 10V, ID = 0.5A	—	8.0	9.0	Ω
Forward Transfer Admittance		Yfs	VDS = 20V, ID = 0.5A	0.2	0.9	—	S
Input Capacitance		Ciss	VDS = 25V, VGS = 0V, f = 1MHz	—	370	—	pF
Reverse Transfer Capacitance		Crss		—	5	—	
Output Capacitance		Coss		—	40	—	
Switching Time	Rise Time	tr	 <p>VGS 10V, 0V ID = 1A VDD ≐ 200V RL = 200Ω 50Ω</p>	—	20	—	ns
	Turn-on Time	ton		—	70	—	
	Fall Time	tf		—	30	—	
	Turn-off Time	toff		VIN : tr, tf < 5ns, Duty ≤ 1%, tw = 10μs	—	95	
Total Gate Charge (Gate-Source Plus Gate-Drain)		Qg	VDD ≐ 400V, VGS = 10V, ID = 1A	—	15	—	nC
Gate-Source Charge		Qgs		—	6	—	
Gate-Drain ("Miller") Charge		Qgd		—	9	—	

SOURCE-DRAIN DIODE RATINGS AND CHARACTERISTICS (Ta = 25°C)

CHARACTERISTIC	SYMBOL	TEST CONDITION	MIN.	TYP.	MAX.	UNIT
Continuous Drain Reverse Current	IDR	—	—	—	1	A
Pulse Drain Reverse Current	IDRP	—	—	—	3	A
Diode Forward Voltage	VDSF	IDR = 1A, VGS = 0V	—	—	-1.9	V
Reverse Recovery Time	trr	IDR = 1A, VGS = 0V	—	750	—	ns
Reverse Recovery Charge	Qrr	dIDR / dt = 100A / μs	—	3	—	μC

MARKING

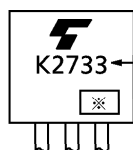

TYPE

※ Lot Number



Month (Starting from Alphabet A)



Year (Last Number of the Christian Era)

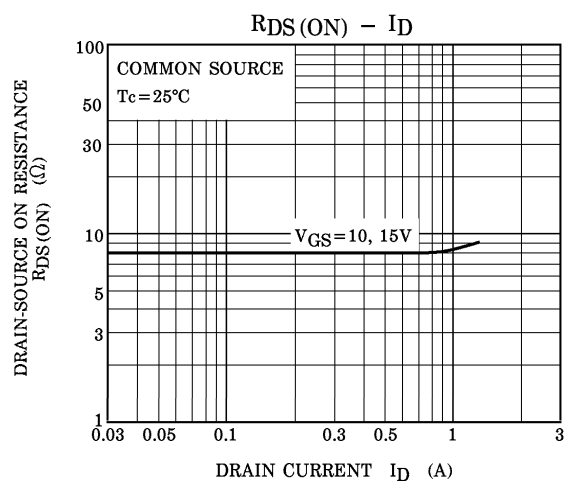
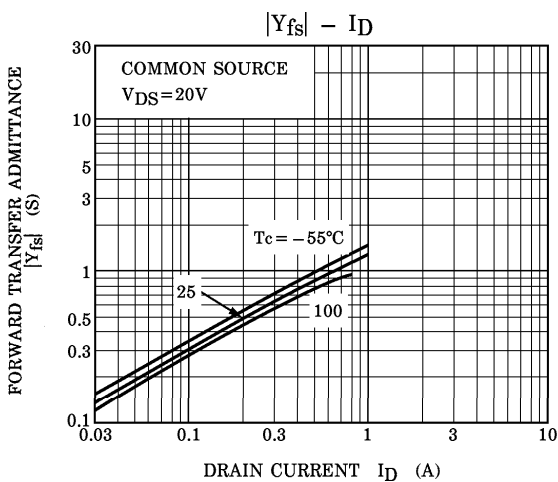
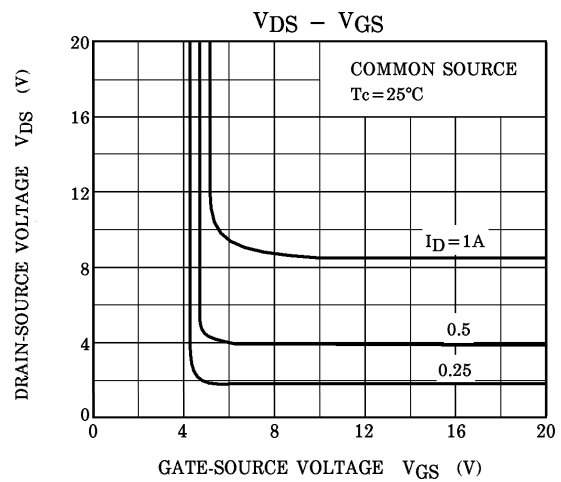
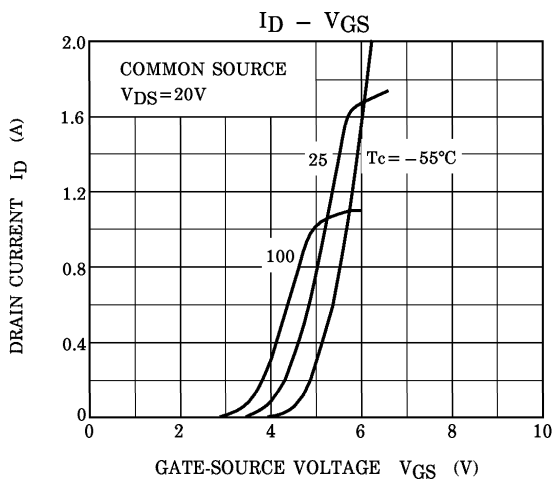
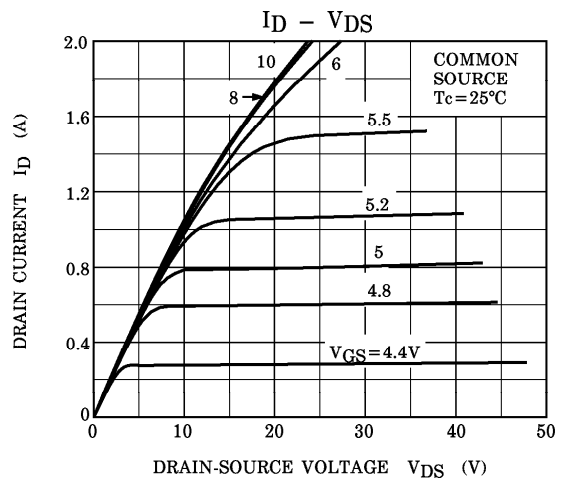
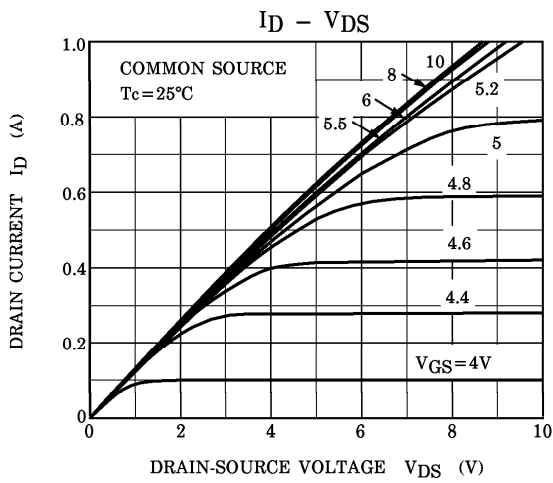

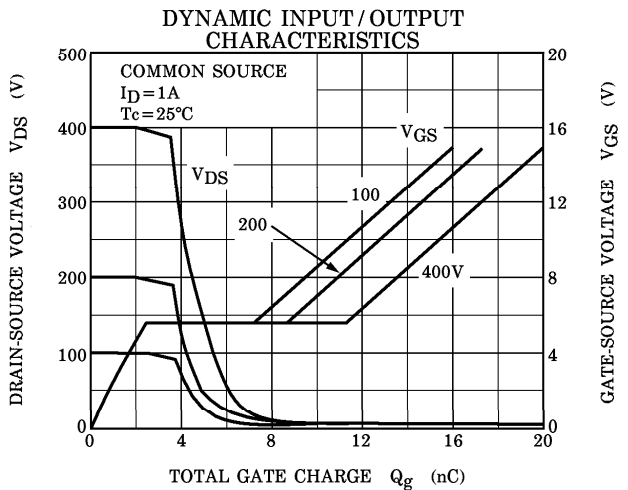
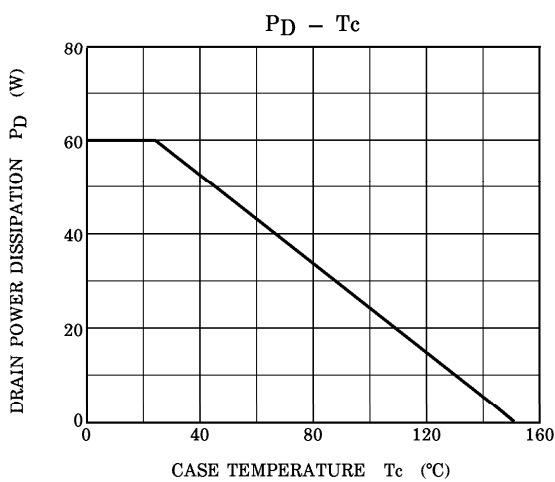
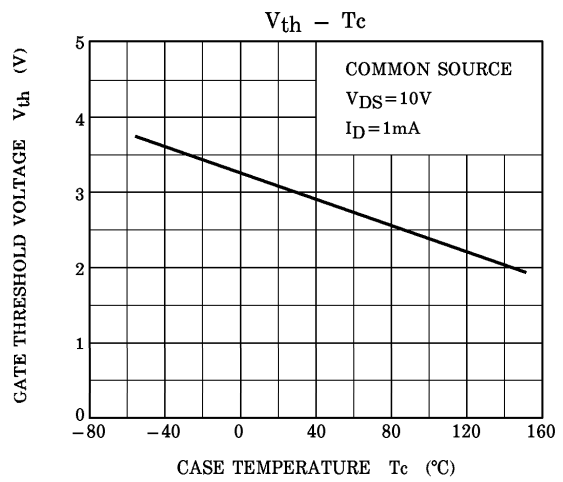
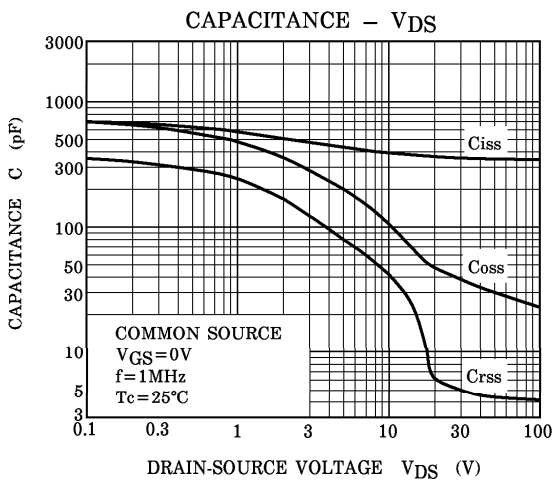
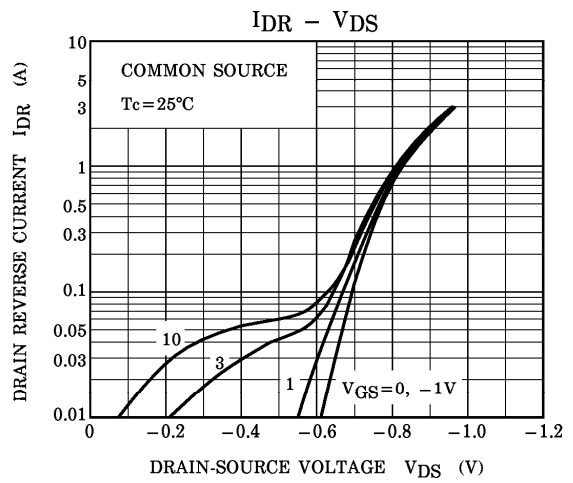
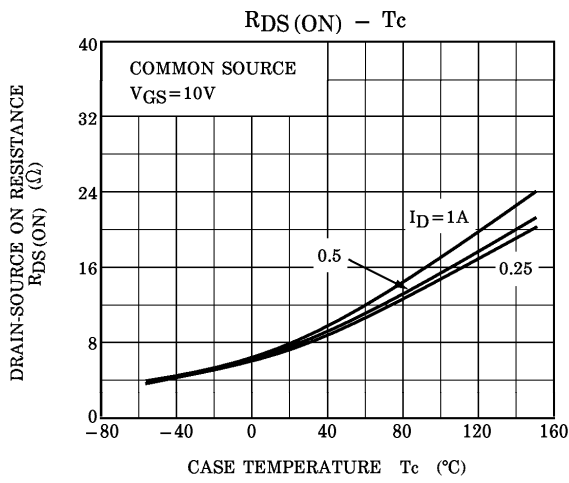

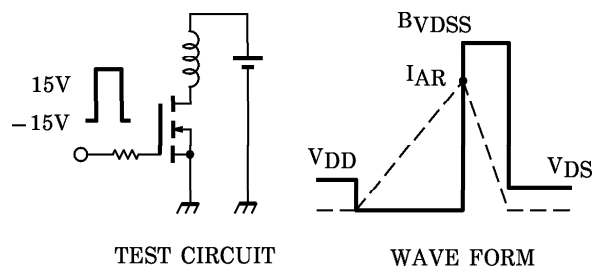
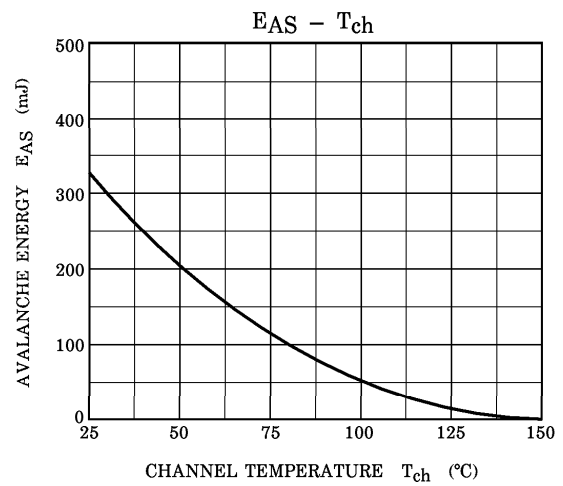
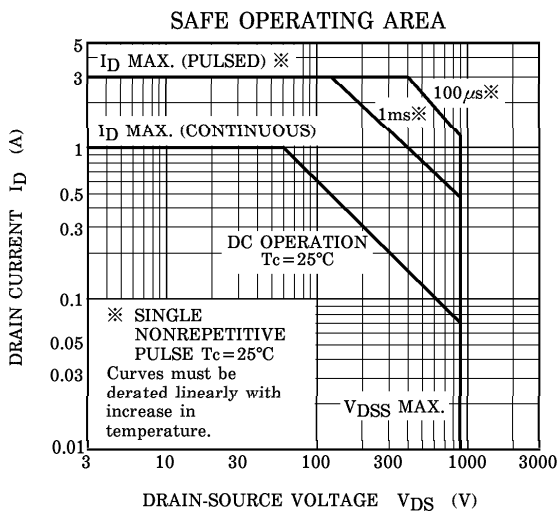
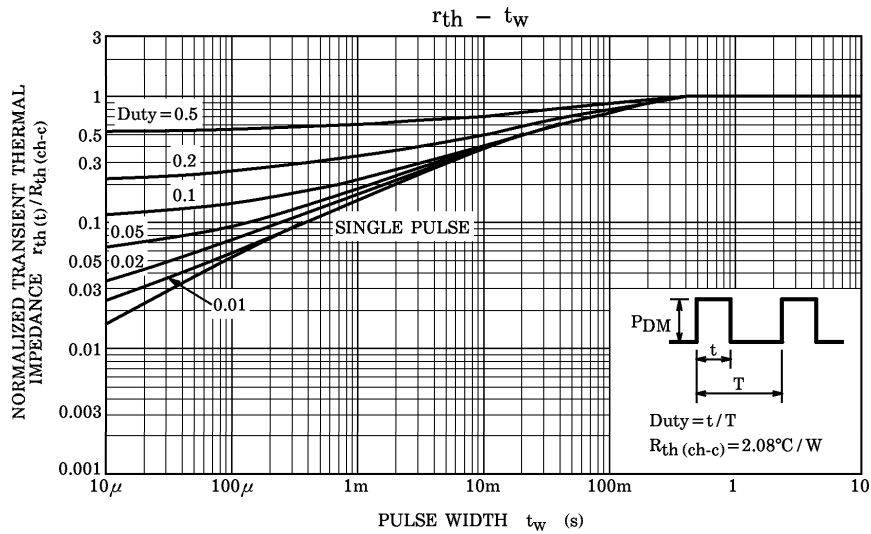

Peak $I_{AR} = 1A$, $R_G = 25\Omega$
 $V_{DD} = 90V$, $L = 594mH$

$$E_{AS} = \frac{1}{2} \cdot L \cdot I^2 \cdot \left(\frac{B_{VDSS}}{B_{VDSS} - V_{DD}} \right)$$