



Princeton Technology Corp. reserves the right to change the product described in this datasheet. All information contained in this datasheet is subject to change without prior notice. Princeton Technology Corp. assumes no responsibility for the use of any circuits shown in this datasheet.

---

---

## Description

The PA2464/PA2464-LF is a Power Amplifier (PA) IC as the final RF amplifier for hand-held applications in the 400MHz to 480MHz band.

---

---

## Features

- ◆ Single 3.5V to 6V Supply Voltage
- ◆ +36dBm Output Power
- ◆ 75% Efficiency
- ◆ 8-pin SOP(FD) package (5mm x 4mm)

---

---

## Applications

- ◆ FRS, GMRS Handsets
- ◆ Commercial and Consumer Systems
- ◆ Portable Battery-Powered Equipment
- ◆ Long distance Remote Control

---

---

## Block Diagram

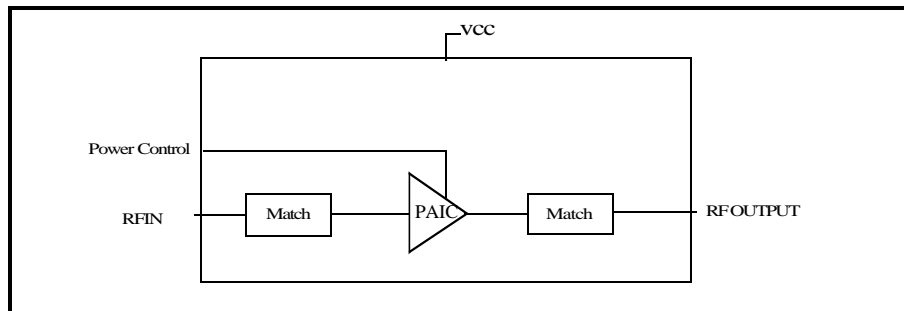



Package and Pin Assignment: 8-Pin SOP(FD)

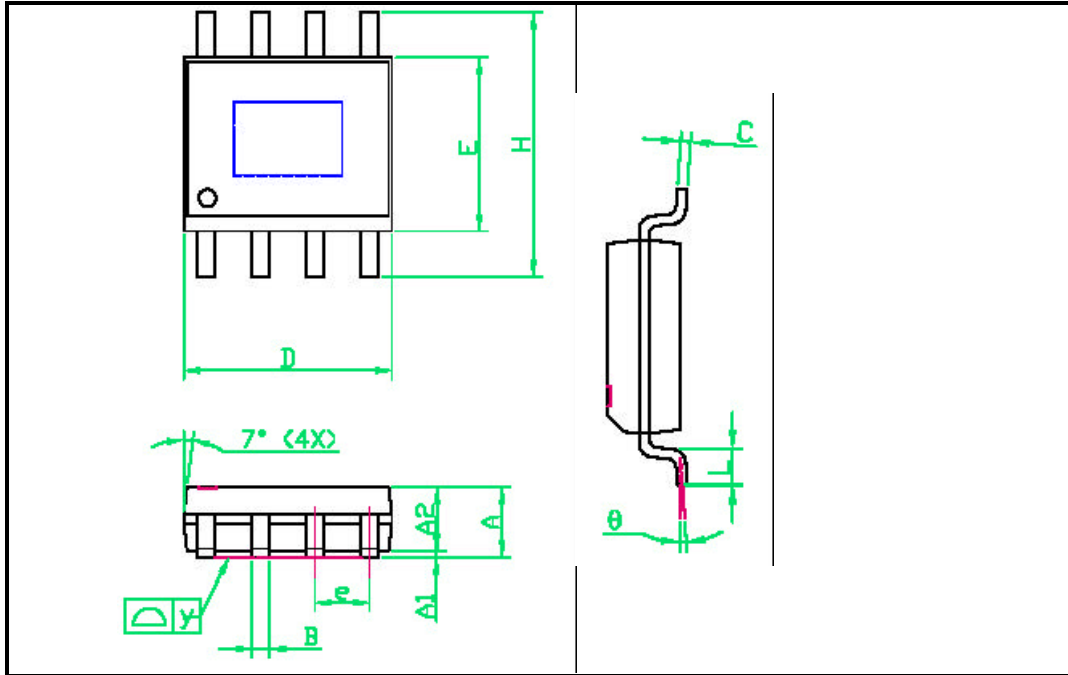

Symbols	Dimensions in mm			Dimensions in inch		
	min.	nom.	max.	min.	nom.	max.
A	1.45	1.50	1.55	0.057	0.059	0.061
A1	0.00	---	0.10	0.000	---	0.004
A2	---	1.45	---	---	0.057	---
B	0.33	---	0.51	0.013	---	0.020
C	0.19	---	0.25	0.007	---	0.010
D	4.80	---	5.00	0.189	---	0.197
E	3.80	---	4.00	0.150	---	0.157
e	---	1.27	---	---	0.050	---
H	5.80	---	6.20	0.228	---	0.244
L	0.40	---	1.27	0.016	---	0.050
y	---	---	0.10	---	---	0.004
θ	0°	---	8°	0°	---	8°



## Pin Descriptions

Number	Name	I/O	Description
1	APC1	I	Analog Power Control
2	NC	I	No Connection
3	RF_IN	I	RF Input
4	VCC	Power	Power supply for PA
5	L2	I	Connect to PIN4 through a matching section,do not short to GND or PIN4.
6	RF_OUT	O	RF Output
7	RF_OUT	O	RF Output
8	APC2	I	Analog Power Control

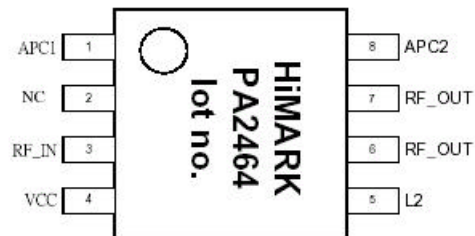



### Absolute Maximum Ratings

$$V_{SS} = V_{SS1} = 0 \text{ V}$$

Parameter	Symbol	Rating	Unit
Supply Voltage	$V_{CC}$	6	V
Supply current	$I_{CC}$	1000	mA
Input Power	$P_{IN}$	10	dBm
Operating Temperature Range	$T_{OPR}$	5 to 100	$^{\circ}\text{C}$
Storage Temperature Range	$T_{STG}$	-40 to 125	$^{\circ}\text{C}$
Soldering Temperature Range	$T_{SLD}$	255	$^{\circ}\text{C}$
Soldering Time Range	$t_{SLD}$	10	s

### Recommended Operating Conditions

$$V_{SS} = V_{SS1} = 0 \text{ V}$$

Parameter	Symbol	Value			Unit
		min.	typ.	max.	
Supply Voltage Range	$V_{CC}$		3.5	6	V
Operating Temperature	$T_A$	-30	25	85	$^{\circ}\text{C}$



## Electrical Characteristics

( $V_{CC} = 6V$ ,  $V_{SS} = 0V$ ,  $T_A = 25^\circ C$ ,  $R_L = 50 \text{ Ohm}$ )

Parameter	Symbol	Condition	Value			Unit
			min.	typ.	max.	
VCC Supply Voltage	$V_{CC}$			6		V
Frequency Range	f		400		480	MHz
Input Power	$P_{IN}$		-	5	-	dBm
Output Power	$P_{OUT}$	$P_{IN} = 5 \text{ dBm}$	-	36		dBm
Efficiency		$P_{IN} = 5 \text{ dBm}$		75		%
Current Consumption	I	$P_{OUT} = 36 \text{ dBm}, V_{CC} = 6 \text{ V}$		900	1000	mA
Control Voltage Range	$V_{APC}$		0.2		1.6	V
Full Power Control Voltage		$P_{OUT} = 36 \text{ dBm}$		1.5		V
Control Current into $V_{APC}$	$I_{APC}$			40		mA
2nd to 13th Harmonic Distortion		$P_{OUT} = 36 \text{ dBm}$		-20		dBc
Input VSWR		All power level		1.5:1	2:1	
Rise Time and Fall Time		$P_{OUT} = 36 \text{ dBm}$			2	$\mu\text{sec}$



## Electrical Characteristics

( $V_{CC} = 4.5V$ ,  $V_{SS} = 0V$ ,  $T_A = 25^\circ C$ ,  $R_L = 50 \text{ Ohm}$ )

Parameter	Symbol	Condition	Value			Unit
			min.	typ.	max.	
VCC Supply Voltage	$V_{CC}$			4.5		V
Frequency Range	f		400		480	MHz
Input Power	$P_{IN}$		-	5	-	dBm
Output Power	$P_{OUT}$	$P_{IN} = 5 \text{ dBm}$	-	35		dBm
Efficiency		$P_{IN} = 5 \text{ dBm}$		65		%
Current Consumption	I	$P_{OUT} = 35 \text{ dBm}, V_{CC} = 4.5 \text{ V}$		1070	1200	mA
Control Voltage Range	$V_{APC}$		0.2		1.4	V
Full Power Control Voltage		$P_{OUT} = 35 \text{ dBm}$		1.3		V
Control Current into $V_{APC}$	$I_{APC}$			40		mA
2nd to 13th Harmonic Distortion		$P_{OUT} = 35 \text{ dBm}$		-20		dBc
Input VSWR		All power level		1.5:1	2:1	
Rise Time and Fall Time		$P_{OUT} = 35 \text{ dBm}$			2	$\mu\text{sec}$



## Electrical Characteristics

( $V_{CC} = 3.5V$ ,  $V_{SS} = 0V$ ,  $T_A = 25^\circ C$ ,  $R_L = 50 \text{ Ohm}$ )

Parameter	Symbol	Condition	Value			Unit
			min.	typ.	max.	
VCC Supply Voltage	$V_{CC}$			3.5		V
Frequency Range	f		400		480	MHz
Input Power	$P_{IN}$		-	5	-	dBm
Output Power	$P_{OUT}$	$P_{IN} = 5 \text{ dBm}$	-	34		dBm
Efficiency		$P_{IN} = 5 \text{ dBm}$		60		%
Current Consumption	I	$P_{OUT} = 34 \text{ dBm}, V_{CC} = 3.5 \text{ V}$		1180	1300	mA
Control Voltage Range	$V_{APC}$		0.2		1.5	V
Full Power Control Voltage		$P_{OUT} = 34 \text{ dBm}$		1.4		V
Control Current into $V_{APC}$	$I_{APC}$			40		mA
2nd to 13th Harmonic Distortion		$P_{OUT} = 34 \text{ dBm}$		-20		dBc
Input VSWR		All power level		1.5:1	2:1	
Rise Time and Fall Time		$P_{OUT} = 34 \text{ dBm}$			2	$\mu\text{sec}$



## Electrical Characteristics

( $V_{CC} = 3.0V$ ,  $V_{SS} = 0V$ ,  $T_A = 25^\circ C$ ,  $R_L = 50 \text{ Ohm}$ )

Parameter	Symbol	Condition	Value			Unit
			min.	typ.	max.	
VCC Supply Voltage	$V_{CC}$			3		V
Frequency Range	f		400		480	MHz
Input Power	$P_{IN}$		-	5	-	dBm
Output Power	$P_{OUT}$	$P_{IN} = 5\text{dBm}$	-	33		dBm
Efficiency		$P_{IN} = 5\text{dBm}$		55		%
Current Consumption	I	$P_{OUT} = 33\text{dBm}, V_{CC} = 3V$		1190	1300	mA
Control Voltage Range	$V_{APC}$		0.2		1.5	V
Full Power Control Voltage		$P_{OUT} = 33\text{dBm}$		1.4		V
Control Current into $V_{APC}$	$I_{APC}$			40		mA
2nd to 13th Harmonic Distortion		$P_{OUT} = 33\text{dBm}$		-20		dBc
Input VSWR		All power level		1.5:1	2:1	
Rise Time and Fall Time		$P_{OUT} = 33\text{dBm}$			2	$\mu\text{sec}$



### Evaluation Board Circuit

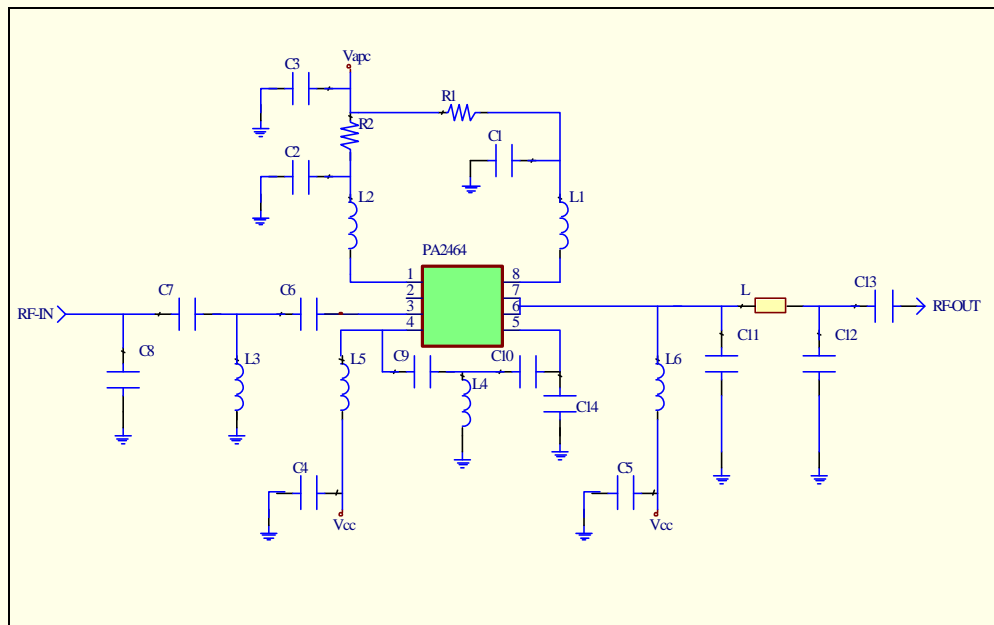

### Evaluation Board Layout

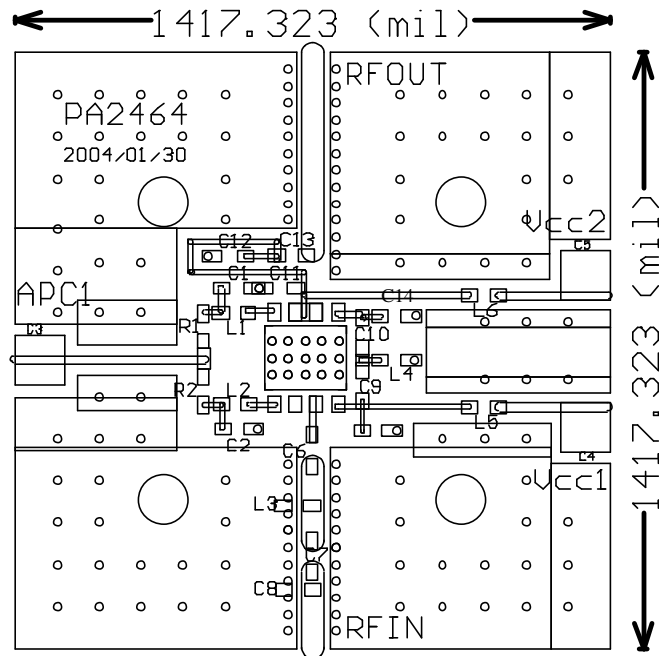



**BOM**

<b>VCC</b>	<b>3V</b>	<b>3.5V</b>	<b>4.5V</b>	<b>6V</b>	<b>6V</b>	<b>6V</b>
<b>Freq.(MHz)</b>	<b>465</b>	<b>465</b>	<b>465</b>	<b>465</b>	<b>465</b>	<b>465</b>
<b>Pout</b>	<b>33dBm</b>	<b>34dBm</b>	<b>35dBm</b>	<b>36dBm</b>	<b>3W</b>	<b>2W</b>
<b>EFF(%)</b>	<b>55</b>	<b>60</b>	<b>65</b>	<b>75</b>	<b>65</b>	<b>55</b>
<b>Vapc</b>	<b>1.42V</b>	<b>1.39V</b>	<b>1.28V</b>	<b>1.5V</b>	<b>1.36V</b>	<b>1.09V</b>
<b>C1/C2</b>	1nF	1nF	1nF	1nF	1nF	1nF
<b>C3/C4/C5</b>	1uF	1uF	1uF	1uF	1uF	1uF
<b>C6</b>	100pF	100pF	100pF	100pF	100pF	100pF
<b>C7</b>	6pF	6pF	6pF	6pF	7pF	4.7pF
<b>C8</b>	6pF	6pF	6pF	18pF	12pF	10pF
<b>C9</b>	18pF	18pF	18pF	100pF	100pF	100pF
<b>C10</b>	100pF	100pF	100pF	11pF	7pF	7pF
<b>C11</b>	6pF	6pF	6pF	5pF	5pF	5pF
<b>C12</b>	7pF	7pF	7pF	8pF	7pF	7pF
<b>C13</b>	4pF	5pF	6pF	15pF	15pF	15pF
<b>C14</b>	6pF	6pF	6pF	-	-	-
<b>L1/L2</b>	100nH	100nH	100nH	100nH	100nH	100nH
<b>L3</b>	15nH	15nH	15nH	15nH	12nH	15nH
<b>L4</b>	-	-	-	10nH	22nH	22nH
<b>*L5/L6</b>	25nH	25nH	25nH	25nH	25nH	25nH
<b>R1/R2</b>	0 ohm	0 ohm	0 ohm	0 ohm	0 ohm	0 ohm

\* air coil inductor



Typical Characteristics

465MHz,  $V_{cc}=6V$ ,  $P_{in}=5dBm$ ,  $V_{apc}=1.5V$

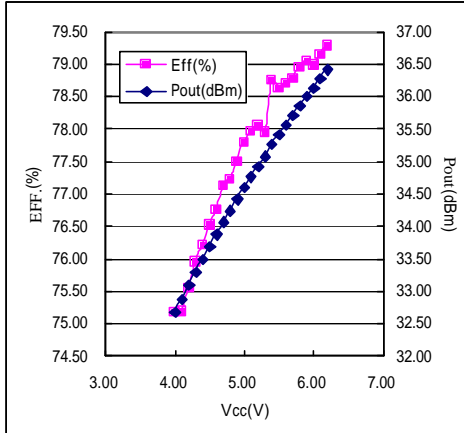

Fig 1.1 Output Power vs. Vcc

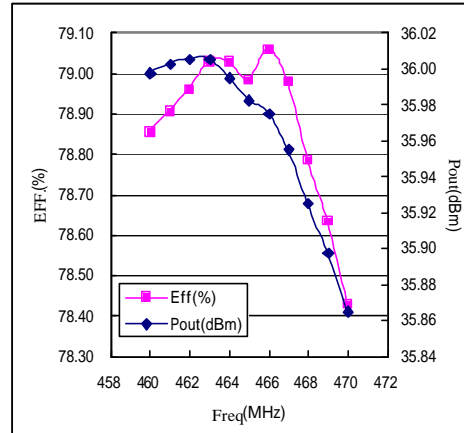

Fig 1.2 Output Power vs. Frequency

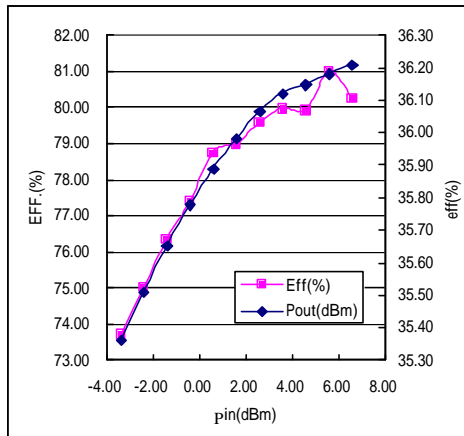

Fig 1.3 Output Power vs. Input Power

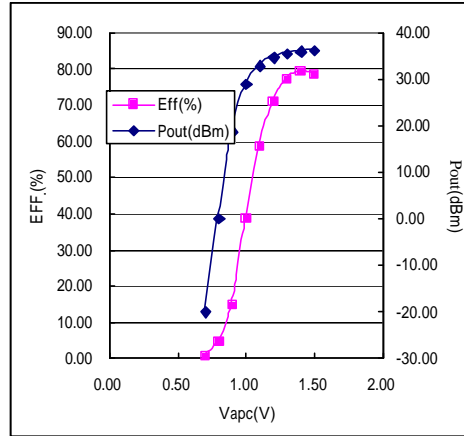

Fig1.4 Output Power vs. Control Voltage



### Typical Characteristics

465MHz,  $V_{cc}=4.5V$ ,  $P_{in}=5dBm$ ,  $V_{apc}=1.28V$

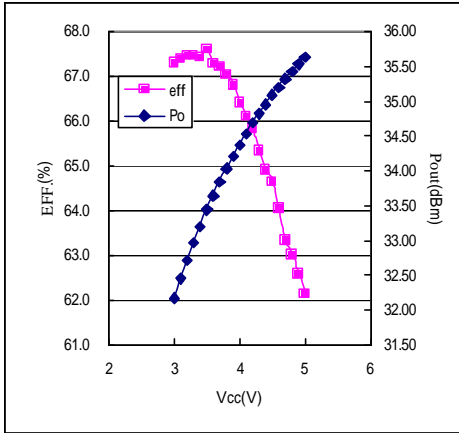

Fig 2.1 Output Power vs. Vcc

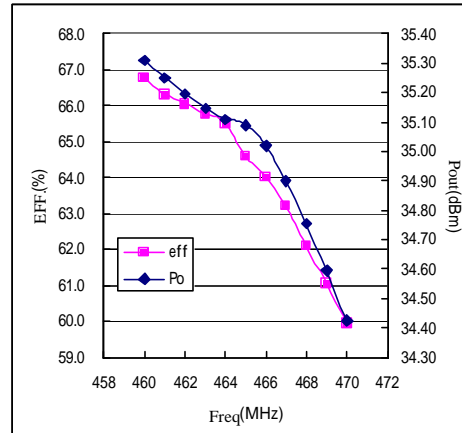

Fig 2.2 Output Power vs. Frequency

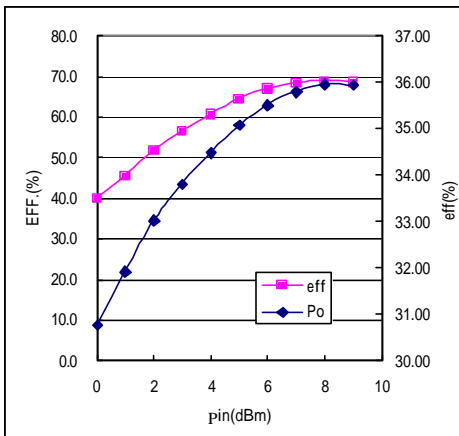

Fig 2.3 Output Power vs. Input Power

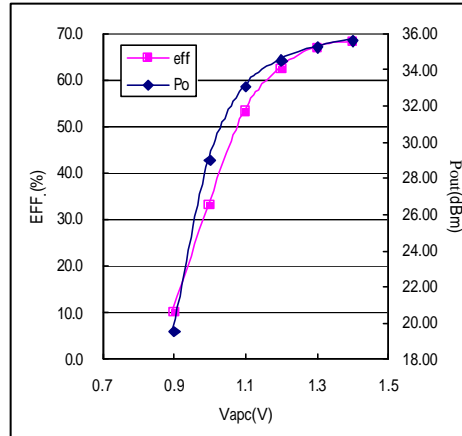

Fig 2.4 Output Power vs. Control Voltage



### Typical Characteristics

465MHz,  $V_{cc}=3.5V$ ,  $P_{in}=5dBm$ ,  $V_{apc}=1.39V$

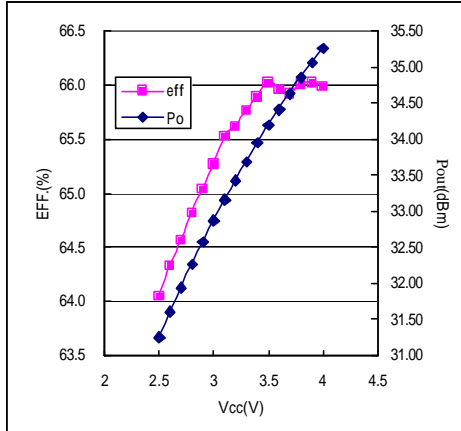

Fig 3.1 Output Power vs. Vcc

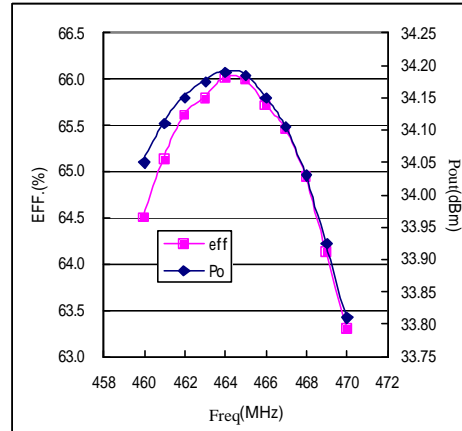

Fig 3.2 Output Power vs. Frequency

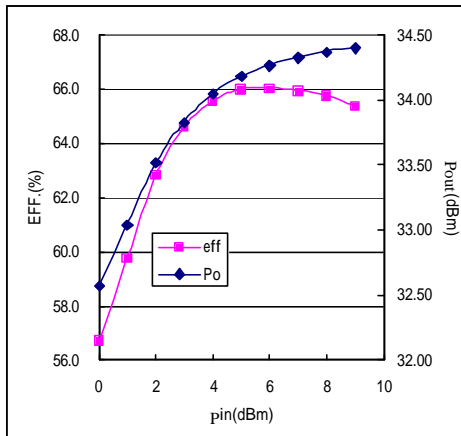

Fig 3.3 Output Power vs. Input Power

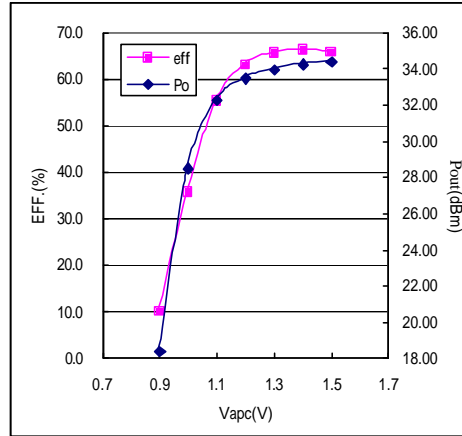

Fig 3.4 Output Power vs. Control Voltage



### Typical Characteristics

465MHz,  $V_{cc}=3V$ ,  $P_{in}=5dBm$ ,  $V_{apc}=1.42V$

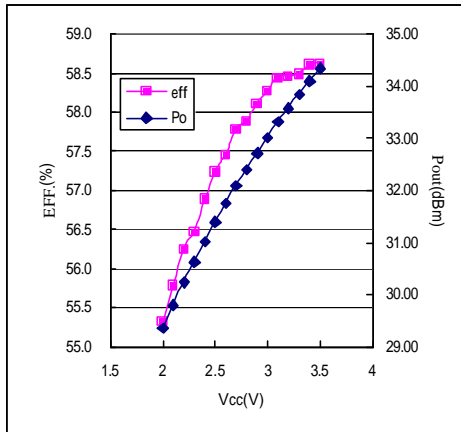

Fig 4.1 Output Power vs. Vcc

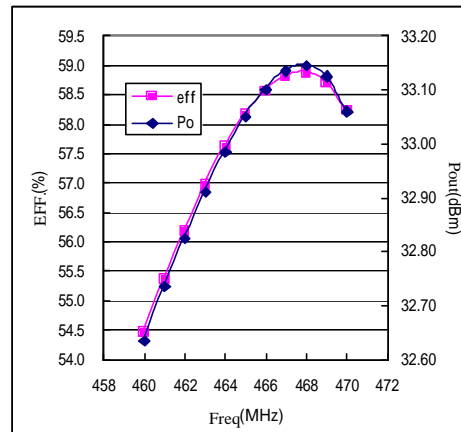

Fig 4.2 Output Power vs. Frequency

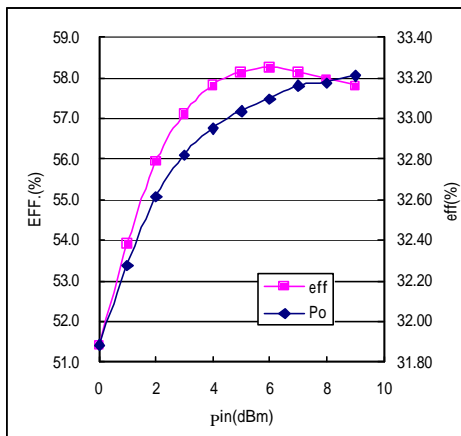

Fig 4.3 Output Power vs. Input Power

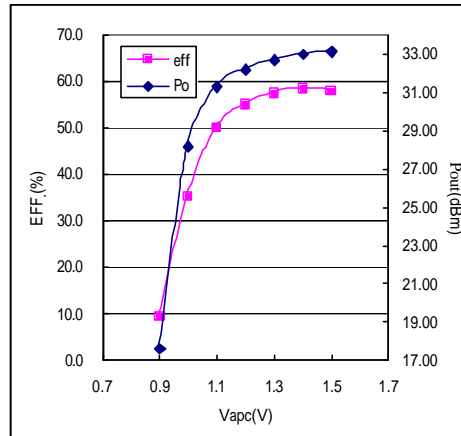
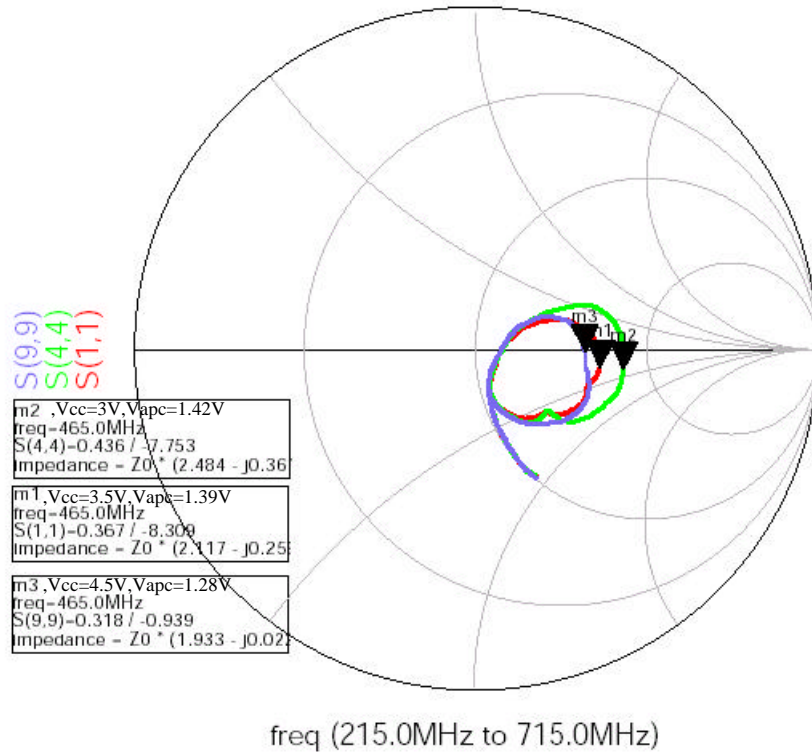

Fig 4.4 Output Power vs. Control Voltage

### Input Impedance

465MHz, Pin=5dBm



NOTE:1. C7=C6=100pF, C8=X, L3=X

2. Z0=50 ohm