

LITEON**LTP-2344
2044 A3 SERIES**

T-41-35

**2.0" 4x4 SINGLE COLOR & MULTICOLOR
DOT MATRIX DISPLAYS****FEATURES**

- 2.0 INCH (50.80mm) MATRIX HEIGHT.
- LOW POWER REQUIREMENT.
- HIGH CONTRAST.
- HIGH BRIGHTNESS.
- SINGLE PLANE, WIDE VIEWING ANGLE.
- SOLID STATE RELIABILITY.
- 4x4 ARRAY WITH X-Y SELECT.
- COMPATIBLE WITH USASCII AND EBCDIC CODES.
- STACKABLE HORIZONTALLY.
- CHOICE OF TWO MATRIX ORIENTATION CATHODE ROW OR CATHODE COLUMN.
- EASY MOUNTING ON P.C. BOARD.
- CATEGORIZED FOR LUMINOUS INTENSITY.
- SINGLE COLOR DISPLAYS HAVE THE CHOICE OF THREE BRIGHT COLORS-GREEN/YELLOW/ORANGE.
- MULTICOLOR DISPLAYS ARE APPLICABLE TO THREE BRIGHT COLORS: GREEN, ORANGE AND YELLOW (GREEN AND ORANGE MIXED).

**DESCRIPTION**

The LTP-2x44 series are 2.0 inch (50.80mm) matrix-height 4x4 dot matrix displays.

The LTP-2044A₃ are multicolor applicable displays. The multicolor displays have gray face and white dot color.

The LTP-2344 series are single color displays. The bright red green, yellow and orange displays have gray face and white dot color. The high efficiency red displays have red face and red dot color.

The green series devices are made from GaP on a utilize LED chips which transparent GaP substrate.

The yellow, orange and high efficiency red series devices utilize LED chips which are made from GaAsP on a transparent GaP substrate.

DEVICES

PART NO. LTP--				DESCRIPTION	PACKAGE DIMENSION	INTERNAL CIRCUIT DIAGRAM
GREEN	YELLOW	ORANGE	MULTI-COLOR			
2344G	2344Y	2344E	—	Anode Row, Cathode Column	A	A
—	—	—	2044A ₃	Anode Row, Cathode Column	B	B

PACKAGE DIMENSIONS

A. LTP-2344

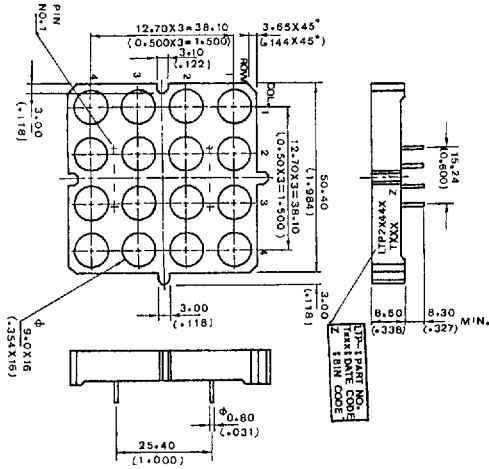

B. LTP-2044A₃

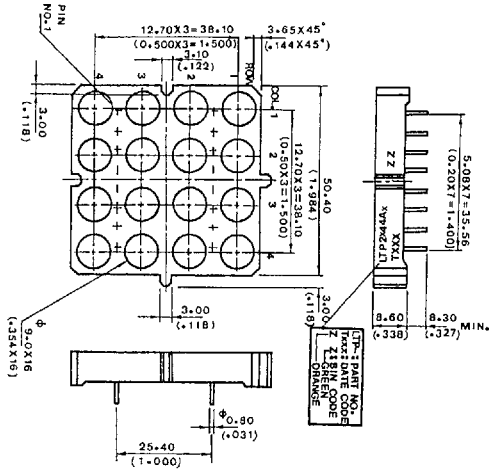

NOTE: All dimensions are in millimeters tolerance are: (inches)

- Lead length (from seating plane): minimum value $\frac{+1.00}{-0.00}$ mm $\frac{+0.040''}{-0.000''}$
- ± 0.25 mm $(0.010'')$ unless otherwise noted.

PIN CONNECTION

PIN NO.	CONNECTION	
	A. LTP-2344	B. LTP-2044A ₃
1	Cathode Column 1	Cathode orange Column 1
2	Cathode Column 2	Cathode Green Column 1
3	Cathode Column 3	Cathode orange Column 2
4	Cathode Column 4	Cathode Green Column 2
5	Anode Row 1	Cathode orange Column 3
6	Anode Row 2	Cathode Green Column 3
7	Anode Row 3	Cathode orange Column 4
8	Anode Row 4	Cathode Green Column 4
9		Anode orange Row 1
10		Anode Green Row 1
11		Anode orange Row 2
12		Anode Green Row 2
13		Anode orange Row 3
14		Anode Green Row 3
15		Anode orange Row 4
16		Anode Green Row 4

DOT MATRIX DISPLAYS

INTERNAL CIRCUIT DIAGRAM

A. LTP-2344

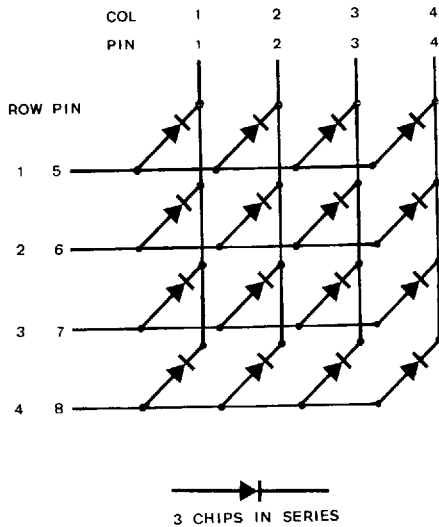

B. LTP-2044A₃

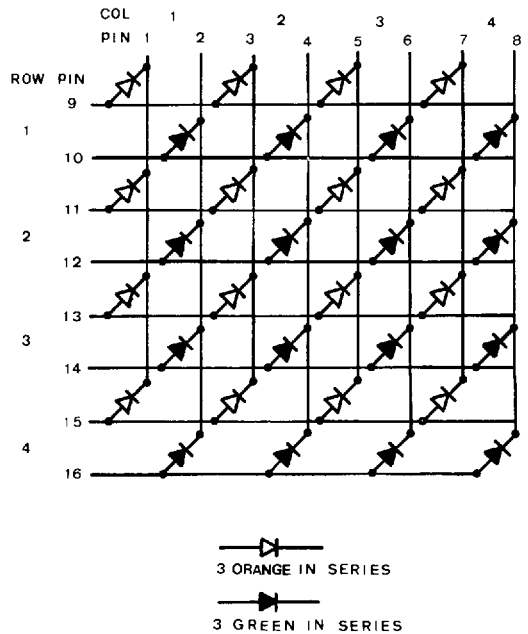

ABSOLUTE MAXIMUM RATINGS AT T_A = 25°C

PARAMETER	GREEN	YELLOW	ORANGE	UNIT
Power Dissipation Per Dot	150	180	150	mW
Peak Forward Current Per Dot (1/10 Duty Cycle, 0.1ms Pulse Width)	75	80	75	mA
Continuous Forward Current Per Dot	18	20	18	mA
Derating Linear From 25°C Per Dot	0.26	0.24	0.26	mA/°C
Reverse Voltage Per Dot	15	15	15	V
Operating Temperature Range	-25°C to +85°C			
Storage Temperature Range	-25°C to +85°C			
Solder Temperature 1/16 inch Below Seating Plane for 3 Seconds at 260°C				

ELECTRICAL/OPTICAL CHARACTERISTICS AT TA = 25°C
LTP-2344G/2044A₃ (GREEN)

PARAMETER	SYMBOL	MIN.	TYP.	MAX.	UNIT	TEST CONDITION
Average Luminous Intensity	I _v	5.0	11.0		mcd	I _F = 48 mA 1/8 DUTY
Peak Emission Wavelength	λ _p		565		nm	I _F = 20 mA
Spectral Line Half-Width	Δλ		30		nm	I _F = 20 mA
Forward Voltage, any Dot	V _F		6.3	8.4	V	I _F = 20 mA
Reverse Current, any Dot	I _R			100	μA	V _R = 15V
Luminous Intensity Matching Ratio	I _v -m			2:1		I _F = 20 mA

TYPICAL ELECTRICAL/OPTICAL CHARACTERISTIC CURVES

(25°C Ambient Temperature Unless Otherwise Noted)

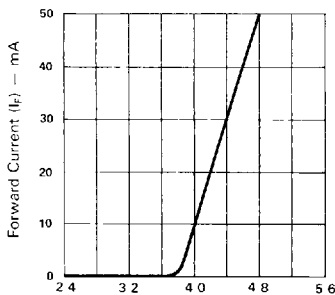

Forward Voltage (V_f) - Volts
 Fig 1 FORWARD CURRENT V_s FORWARD VOLTAGE

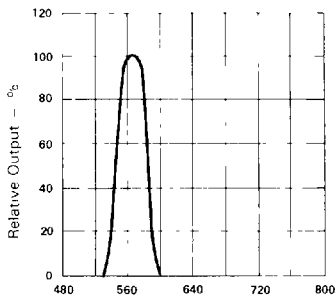

Wavelength (λ) - nm
 Fig 2 SPECTRAL RESPONSE

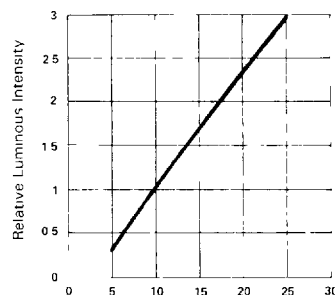

Forward Current (I_f) - mA
 Fig 3 RELATIVE LUMINOUS INTENSITY V_s FORWARD CURRENT (PER SEGMENT)

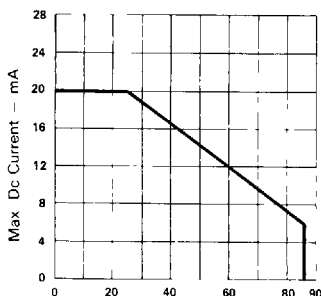

Ambient Temperature (T_a) - °C
 Fig 4 MAX ALLOWABLE DC CURRENT PER SEG V_s AMBIENT TEMPERATURE

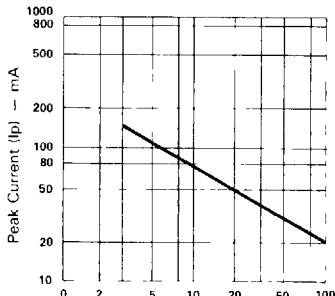

Duty Cycle %
 Fig 5 MAX PEAK CURRENT V_s DUTY CYCLE % (REFRESH RATE F = 1 KHz)

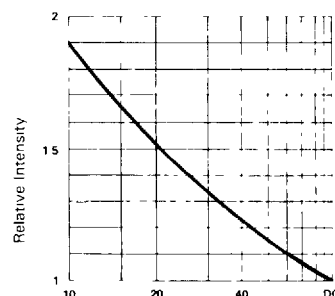

Duty Cycle %
 Fig 6 LUMINOUS INTENSITY V_s DUTY CYCLE % (AVERAGE I_f = 10mA PER SEG)

DOT MATRIX
 DISPLAYS

ELECTRICAL/OPTICAL CHARACTERISTICS AT $T_A = 25^\circ\text{C}$
LTP-2344Y

PARAMETER	SYMBOL	MIN.	TYP.	MAX.	UNIT	TEST CONDITION
Average Luminous Intensity	I_V	5.0	9.0		mcd	$I_F = 48\text{mA}$ 1/8 DUTY
Peak Emission Wavelength	λ_p		585		nm	$I_F = 20\text{mA}$
Spectral Line Half-Width	$\Delta\lambda$		35		nm	$I_F = 20\text{mA}$
Forward Voltage, any Dot	V_F		6.3	8.4	V	$I_F = 20\text{mA}$
Reverse Current, any Dot	I_R			100	μA	$V_R = 15\text{V}$
Luminous Intensity Matching Ratio	$I_{v,m}$			2:1		$I_F = 20\text{mA}$

TYPICAL ELECTRICAL/OPTICAL CHARACTERISTIC CURVES

(25°C Ambient Temperature Unless Otherwise Noted)

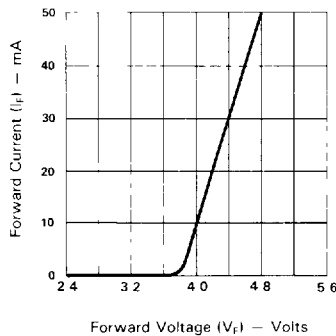

Fig 1 FORWARD CURRENT VS FORWARD VOLTAGE

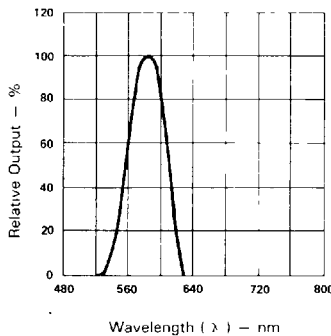

Fig 2 SPECTRAL RESPONSE

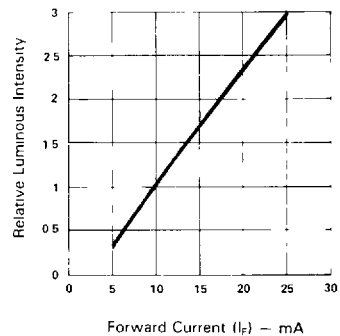

Fig 3 RELATIVE LUMINOUS INTENSITY VS FORWARD CURRENT (PER SEGMENT)

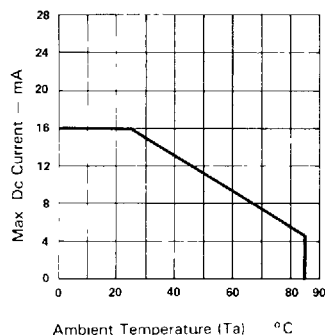

Fig 4 MAX ALLOWABLE DC CURRENT PER SEG VS AMBIENT TEMPERATURE

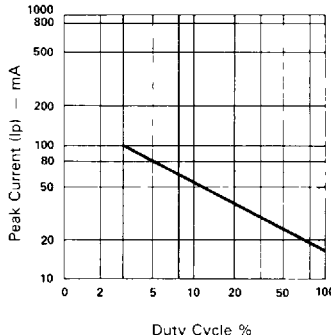

Fig 5 MAX PEAK CURRENT VS DUTY CYCLE % (REFRESH RATE - F = 1 KHZ)

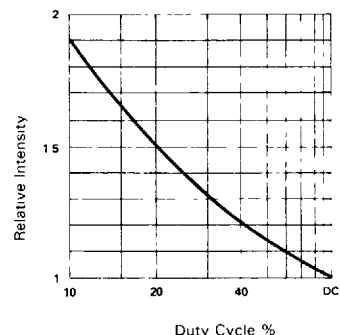

Fig 6 LUMINOUS INTENSITY VS DUTY CYCLE % (AVERAGE $I_F = 10\text{mA}$ PER SEG)

**ELECTRICAL/OPTICAL CHARACTERISTICS AT $T_A = 25^\circ C$
LTP-2344E/2044A₃ (ORANGE)**

PARAMETER	SYMBOL	MIN.	TYP.	MAX.	UNIT	TEST CONDITION
Average Luminous Intensity	I_v	5.0	11.0		mcd	$I_F = 48 \text{ mA}$ 1/8 DUTY
Peak Emission Wavelength	λ_p		630		nm	$I_F = 20 \text{ mA}$
Spectral Line Half-Width	$\Delta\lambda$		35		nm	$I_F = 20 \text{ mA}$
Forward Voltage, any Dot	V_F		6.3	8.4	V	$I_F = 20 \text{ mA}$
Reverse Current, any Dot	I_R			100	μA	$V_R = 15V$
Luminous Intensity Matching Ratio	$I_v\text{-m}$			2:1		$I_F = 20 \text{ mA}$

TYPICAL ELECTRICAL/OPTICAL CHARACTERISTIC CURVES

($25^\circ C$ Ambient Temperature Unless Otherwise Noted)

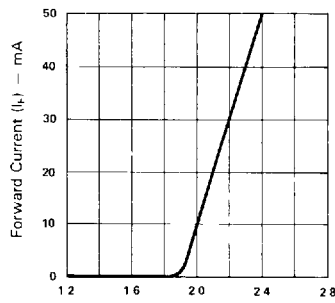

Forward Voltage (V_F) — Volts
Fig 1 FORWARD CURRENT VS FORWARD VOLTAGE

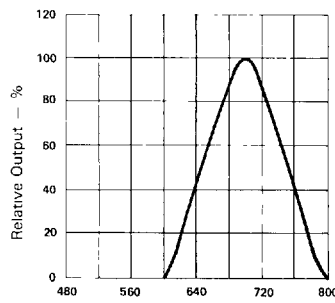

Wavelength (λ) — nm
Fig 2 SPECTRAL RESPONSE

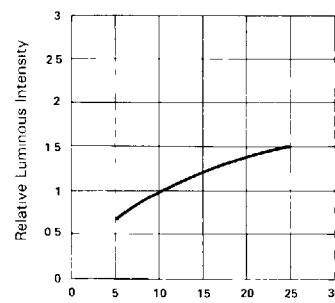

Forward Current (I_F) — mA
Fig 3 RELATIVE, LUMINOUS INTENSITY VS FORWARD CURRENT (PER SEGMENT)

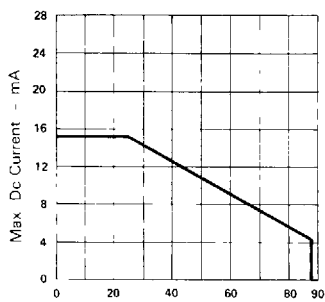

Ambient Temperature (T_A) — $^\circ C$
Fig 4 MAX ALLOWABLE DC CURRENT PER SEG VS AMBIENT TEMPERATURE

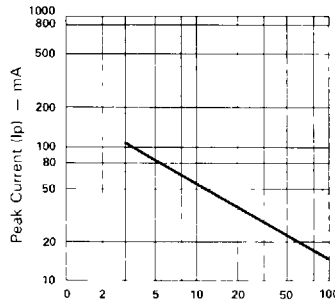

Duty Cycle %
Fig 5 MAX PEAK CURRENT VS DUTY CYCLE % (REFRESH RATE $F = 1 \text{ KHz}$)