

Digital Radio Transmitter Modules for 21.2 to 23.6 GHz

Technical Data

DRT1-23XX

Features

- **Integrated Microwave/ Millimeter-Wave Modules**
- **Low Phase Noise**
- **Silicon Bipolar VCO**
- **Full Band Tuning**
- **GaAs MMIC Output Stage**
- **Sample Output for Phase Locking**
- **Excellent Tuning Linearity**
- **30 dB Attenuator**
- **Waveguide/SMA RF Output**
- **Detected Output**

Description

This digital radio transmitter module is designed for medium data rate point to point communication systems operating at 23 GHz. This module offers excellent phase noise performance and can be easily phase locked to a frequency reference. The transmitter module provides +20 dBm of output power, ideal for use in radios using 2 and 4 level FSK modulation. The module features an ultra low noise silicon bipolar VCO operating in the S/C band. A portion of the oscillator output is coupled off and is applied to a frequency divider network.

The low frequency output (less than 1 GHz) from the frequency divider can be easily used to phase lock the source. The main oscillator output is applied to a frequency multiplier network to produce the desired output frequency in the 23 GHz range. The output of this network is filtered then amplified by a GaAs MMIC device to produce the required output power. A detected sample of the output signal is provided to facilitate built in test of key radio components.

Applications

This digital radio module supplies the transmitter function in radios operating in the 21.2 to 23.6 GHz band. The source provides close to 100 mW output power over the temperature range of -30°C to +70°C. Included within the transmitter module is a muting function to reduce output power by 50 dB for "hot standby" applications. An internal voltage controlled attenuator function is optional allowing for 30 dB dynamic range adjustment.

Block Diagrams

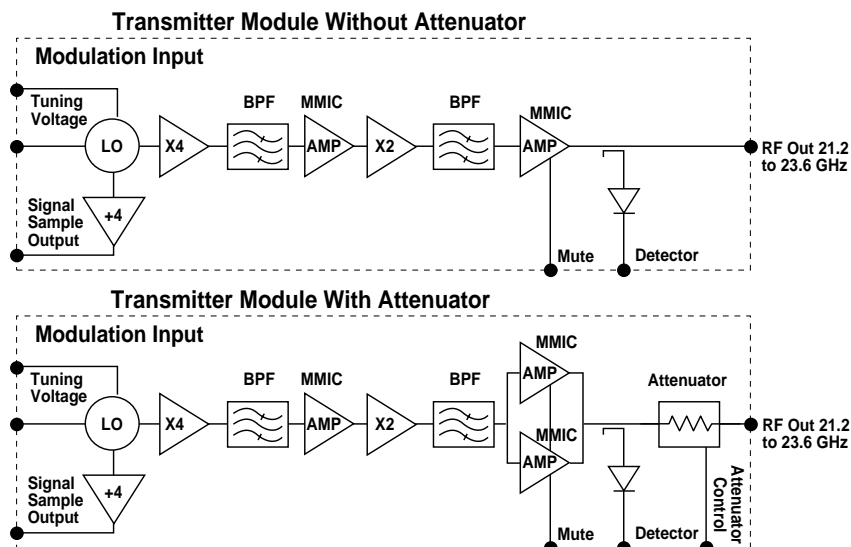

DRT1-23XX Absolute Maximum Ratings (T_A = -30 to +70°C)

Parameters	Units	Ratings
DC Circuit Power +10	Volts	11
+5.0	Volts	+5.5
-5.0	Volts	-4.5
Power Control	Volts	5
Tuning Voltage	Volts	17

Notes:

1. Operation in excess of any one of these parameters may result in permanent damage.
2. A thermal interface medium must be used between the bottom of the package and its mating surface to ensure optimum heat transfer.

Electrical Characteristics

Part Number		DRT1-2321 or DRT1-2322			DRT1-2311 or DRT1-2312		
Parameters	Units	Min.	Typ.	Max.	Min.	Typ.	Max.
RF Tuning Range	GHz	21.2		23.6	21.2		23.6
Operating Temperature Range	°C	-30		70	-30		70
Storage Temperature Range	°C	-45		85	-45		85
RF Power Output	dBm	19	20		19	20	
Sample Out Frequency	MHz	663		738	663		738
Sample Out Power	dBm	-10		0	-10		0
Detected Out	V	0.4		2	0.4		2
Harmonics and Sub-Harmonics from 2.65 to 55 GHz from carrier ^[1]	dBc			-30			-30
Spurious Output from 2.65 - 55 GHz ^[1]	dBc			-30			-30
@ fo ± 1.0 GHz	dBc			-50			-50
@ fo ± sample out frequency	dBc			-40			-40
Phase Noise @ 100 KHz	dBc		-85	-82		-85	-82
Tuning Voltage	V	1		16	1		16
Input Capacitance, Nom	pf		27			27	
Main Tuning Sensitivity	MHz/V		260	335		260	335
Main Tuning Sensitivity Variation			1.5:1	2.0:1		1.5:1	2.0:1
Modulation Bandwidth	MHz		20			20	
Modulation Sensitivity	MHz/V	7		25	7		25
Modulation Sensitivity Variation over any 300 MHz			1.15:1			1.15:1	
DC Circuit Power +10 Volts	mA			175			175
+5 Volts	mA			975			600
-5 Volts	mA			50			50
Frequency Pushing on +10V Line based on ± 0.2V variation	MHz/V		40	50		40	50
Return Loss @ Full Power Output ^[2]	dB		10			10	
Mute Control	dBc		-50			-50	
Mute Control Range	V	0		5	0		5
RF Connector		WR 42 or Coax			WR 42 or Coax		
Attenuator Range	dB	30				NA	
Attenuator Control Voltage	V	0		5		NA	
RF Output Dynamic Range		30 Min.			NA		
Humidity Non Condensing	%		85			85	
Condensing	%		95			95	
Case Size	inches	3.50 x 1.25 x 0.40			3.50 x 1.25 x 0.40		

Notes:

1. Tested only to 50 GHz
2. Module is unconditionally stable with this load VSWR of 2.0:1

DRT1-23XX Typical Performance

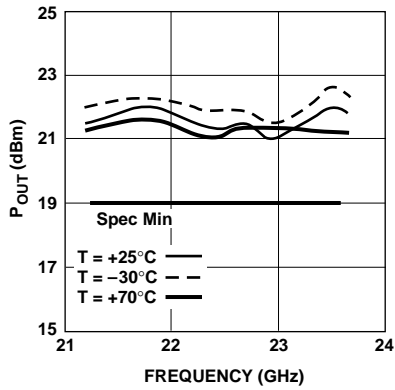

Figure 1. Power Out vs. Frequency.

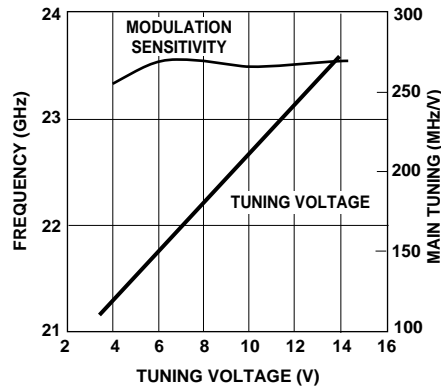

Figure 2. Tuning Voltage vs. Frequency and Modulation Sensitivity.

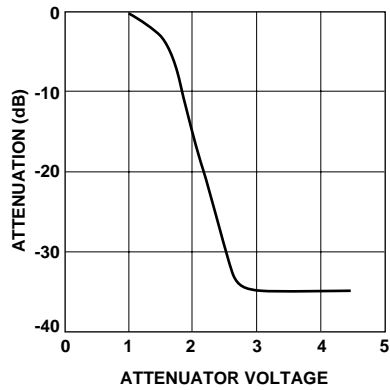

Figure 3. Dynamic Range Adjust.

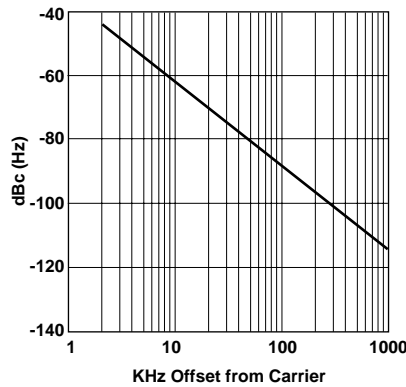

Figure 4. Phase Noise at 23 GHz vs. KHz Offset from Carrier.

Powering Up Instructions

The -5 volts must be applied to the receiver module **before** applying the +5 volts. Likewise when shutting down the receiver module the +5 volts must be removed before the -5 volts is

turned off. The +10 volts can be turned on in any sequence. Failure to follow this procedure could cause permanent damage to the module.

Mounting Instructions

Case must be mounted firmly, with screws, to an adequate metallic structure that has sufficient thermal properties to maintain the module case at a temperature not to exceed 70°C.

Product Options

Specify part number followed by option. For example:

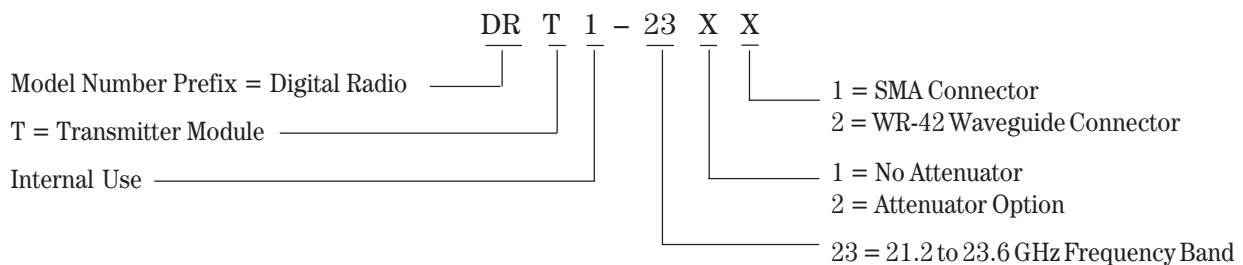

Case Dimensions

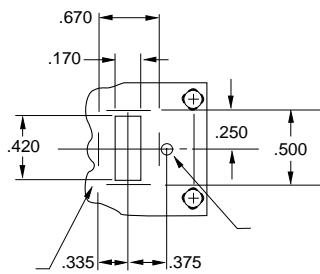
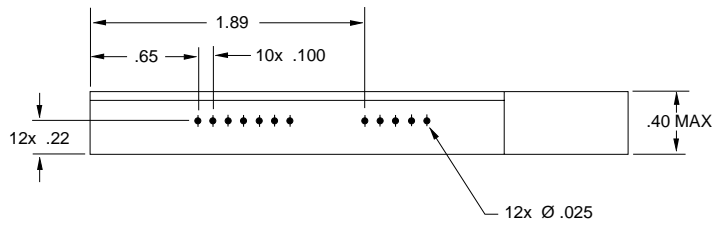
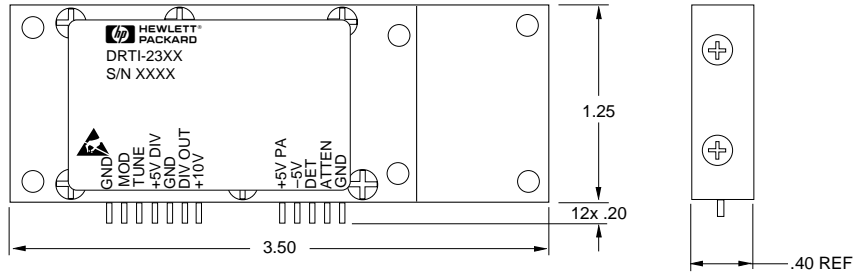

DETAIL A

