

PNP Silicon High-Voltage Transistors

BF 721
BF 723

- Suitable for video output stages in TV sets and switching power supplies
- High breakdown voltage
- Low collector-emitter saturation voltage
- Low capacitance
- Complementary types: BF 720/722 (NPN)

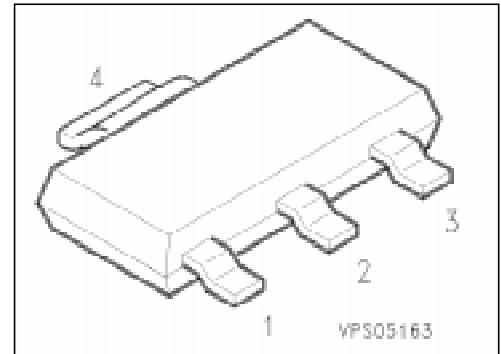

Type	Marking	Ordering Code (tape and reel)	Pin Configuration				Package ¹⁾
			1	2	3	4	
BF 721 BF 723	BF 721 BF 723	Q62702-F1239 Q62702-F1309	B	C	E	C	SOT-223

Maximum Ratings

Parameter	Symbol	Values		Unit
		BF 721	BF 723	
Collector-emitter voltage	V_{CE0}	–	250	V
	V_{CER}	300	–	
Collector-base voltage	V_{CB0}	300	250	V
Emitter-base voltage	V_{EB0}	5	5	
Collector current	I_C	50		mA
Peak collector current	I_{CM}	100		
Total power dissipation, $T_s \leq 110 \text{ °C}^2)$	P_{tot}	1.5		W
Junction temperature	T_j	150		°C
Storage temperature range	T_{stg}	– 65 ... + 150		

Thermal Resistance

Junction - ambient ²⁾	$R_{th JA}$	≤ 87	K/W
Junction - soldering point	$R_{th JS}$	≤ 27	

¹⁾ For detailed information see chapter Package Outlines.

²⁾ Package mounted on epoxy pcb 40 mm × 40 mm × 1.5 mm/6 cm² Cu.

Electrical Characteristics

at $T_A = 25\text{ °C}$, unless otherwise specified.

Parameter	Symbol	Values			Unit
		min.	typ.	max.	

DC characteristics

Collector-emitter breakdown voltage $I_C = 1\text{ mA}$, $I_B = 0$ BF 723	$V_{(BR)CE0}$	250	–	–	V
Collector-emitter breakdown voltage $I_C = 10\text{ }\mu\text{A}$, $R_{BE} = 2.7\text{ k}\Omega$ BF 721	$V_{(BR)CER}$	300	–	–	
Collector-base breakdown voltage $I_C = 10\text{ }\mu\text{A}$, $I_B = 0$ BF 721 BF 723	$V_{(BR)CB0}$	300 250	– –	– –	
Emitter-base breakdown voltage $I_E = 10\text{ }\mu\text{A}$, $I_C = 0$	$V_{(BR)EB0}$	5	–	–	
Collector-base cutoff current $V_{CB} = 200\text{ V}$, $I_E = 0$	I_{CB0}	–	–	10	nA
Collector-emitter cutoff current $V_{CE} = 200\text{ V}$, $R_{BE} = 2.7\text{ k}\Omega$ $V_{CE} = 200\text{ V}$, $R_{BE} = 2.7\text{ k}\Omega$, $T_A = 150\text{ °C}$	I_{CER}	– –	– –	50 10	nA μA
Emitter-base cutoff current $V_{EB} = 5\text{ V}$, $I_C = 0$	I_{EB0}	–	–	10	μA
DC current gain ¹⁾ $I_C = 25\text{ mA}$, $V_{CE} = 20\text{ V}$	h_{FE}	50	–	–	–
Collector-emitter saturation voltage $I_C = 30\text{ mA}$, $I_B = 5\text{ mA}$	V_{CEsat}	–	–	0.6	V

AC characteristics

Transition frequency $I_C = 10\text{ mA}$, $V_{CE} = 10\text{ V}$, $f = 100\text{ MHz}$	f_T	–	100	–	MHz
Collector-base capacitance $V_{CB} = 30\text{ V}$, $I_C = 0$, $f = 1\text{ MHz}$	C_{obo}	–	0.8	–	pF

¹⁾ Pulse test conditions: $t \leq 300\text{ }\mu\text{s}$, $D = 2\text{ %}$.

Total power dissipation $P_{tot} = f(T_A^*; T_S)$

* Package mounted on epoxy

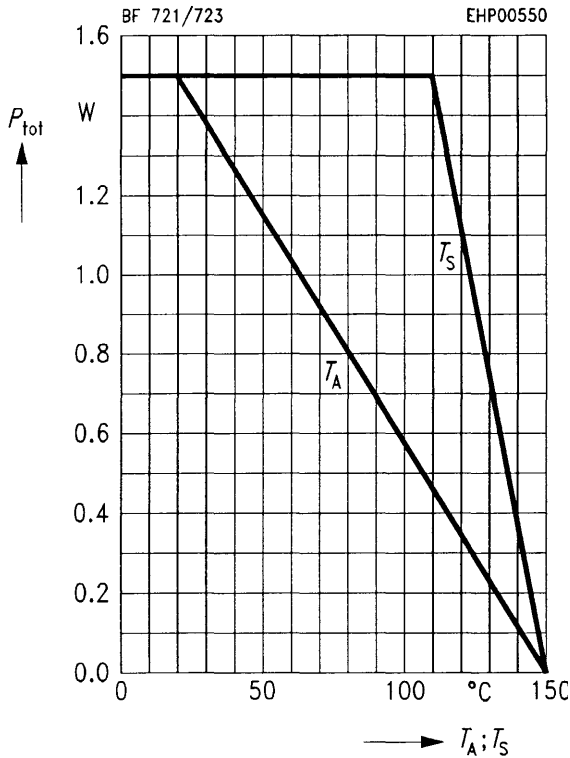

Collector cutoff current $I_{CB0} = f(T_A)$

$V_{CB} = 200$ V

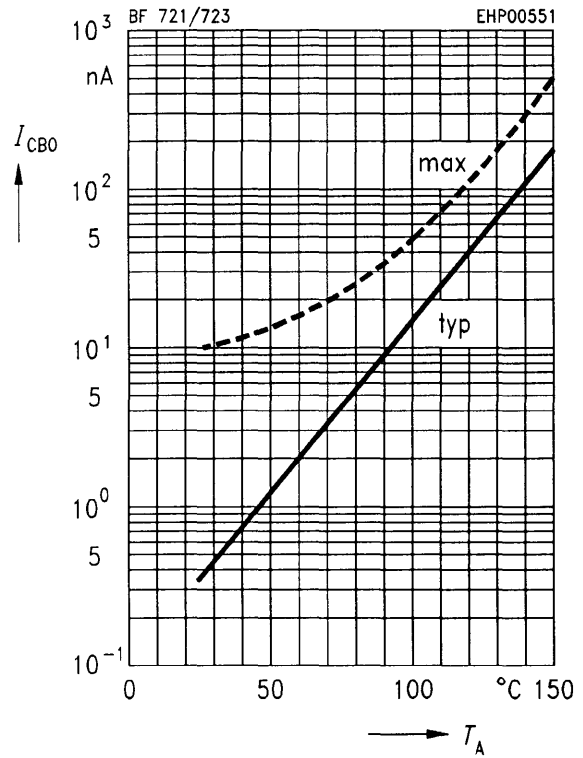

Collector current $I_C = f(V_{BE})$

$V_{CE} = 20$ V

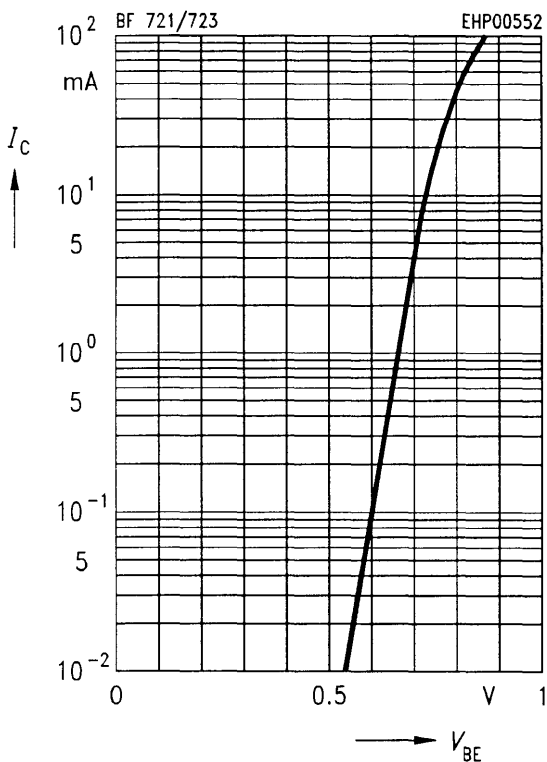

Permissible pulse load $P_{tot max}/P_{tot DC} = f(t_p)$

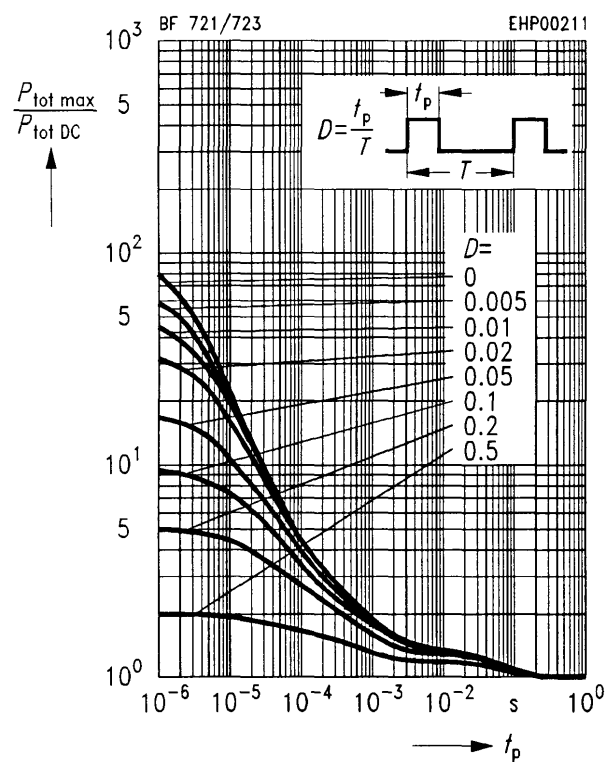

DC current gain $h_{FE} = f(I_C)$

$V_{CE} = 20 \text{ V}$

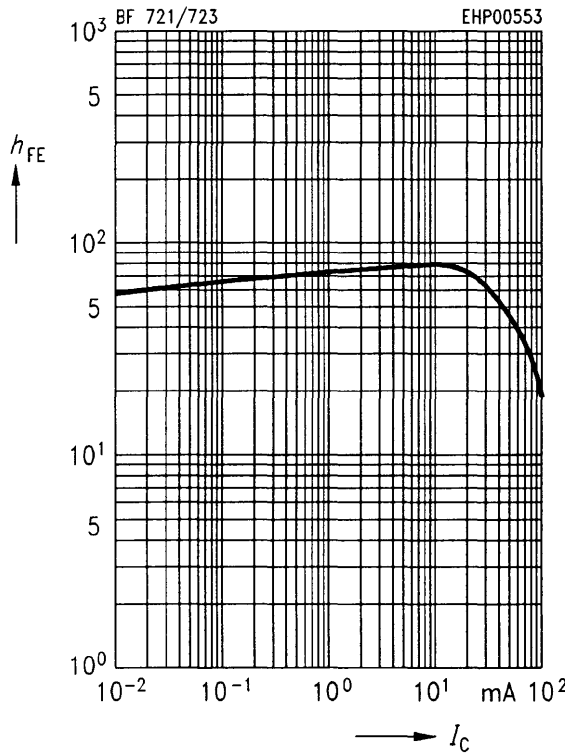

Transition frequency $f_T = f(I_C)$

$V_{CE} = 10 \text{ V}, f = 100 \text{ MHz}$

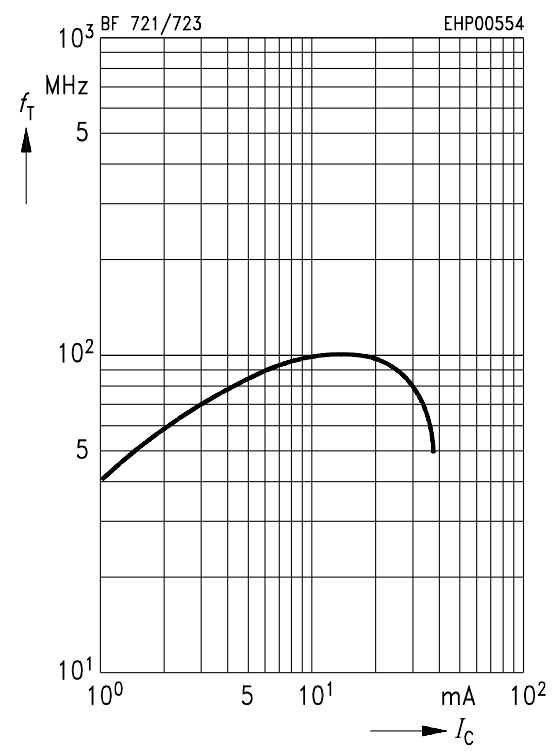

Collector-base capacitance $C_{obo} = f(V_{CB})$

$I_C = 0, f = 1 \text{ MHz}$

