

AKD4380

Evaluation board Rev.A for AK4380

GENERAL DESCRIPTION

The AKD4380 is an evaluation board for AK4380, which is 96kHz sampling 24Bit $\Delta\Sigma$ DAC. AKD4380 has the interface with AKM's wave generator using ROM data and with AKM's A/D converter evaluation boards. Therefore, it is easy to evaluate the AK4380. The AKD4380 also has the digital audio interface and can achieve the interface with digital audio systems via opt-connector or RCA connector.

■ **Ordering guide**

AKD4380 --- Evaluation board for AK4380

FUNCTION

- **Compatible with 2 types of interface**
 - Direct interface with AKM's A/D converter evaluation boards (539X,535X) ,and direct interface with a signal generator (AKD43XX)
 - On-board CS8414 as DIR which accepts optical or RCA input.
- **BNC connector for an external clock input by 10 pin Header.**

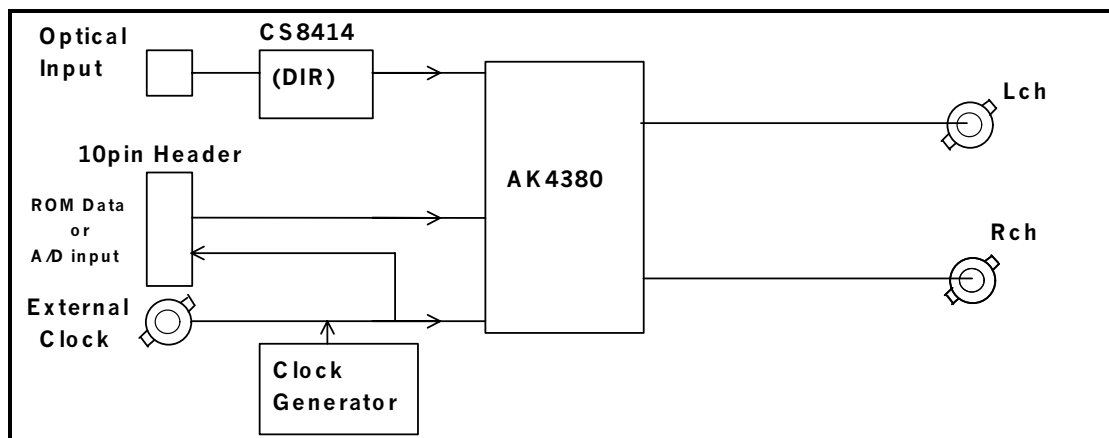

Figure 1. AKD4380 Block Diagram

■ **Analog output**

Analog signal is output through BNC connectors on the board. And the output level of AK4380 is 3.45Vpp.

■ **Operation sequence**

- 1) Set up the power supply lines.
 - [VA] (red) = 4.5 ~ 5.5V
 - [VD] (red) = 4.5 ~ 5.5V
 - [AGND] (black) = 0V
 - [DGND] (black) = 0V

Each supply line should be distributed from the power supply unit.

- 2) Set up the evaluation mode, jumper pins and DIP switches. (See the followings.)
- 3) Power on.
 - The AK4380 should be reset once bringing upon power-up

■ **Evaluation mode**

Applicable evaluation modes

- 1) DIR (Optical Link and RCA) (default)
- 2) Using ROM data (AK43XX)
- 3) Using AKM's evaluation board for ADC
- 4) Feeding all signals from external

1) DIR(Optical Link)

PORT3(TORX176) or J3(RCA) is used. All clock are supplied from CS8414(DIR). DIR generates MCLK, BICK, LRCK and SDATA from the received data through optical connector (TORX176) or RCA connector. Used for the evaluation using CD test disk. Nothing should be connected to PORT2. In case of using optical connector (TORX176), select "OPT" on JP14(DIR/RX). In case of using RCA connector, select "RX".

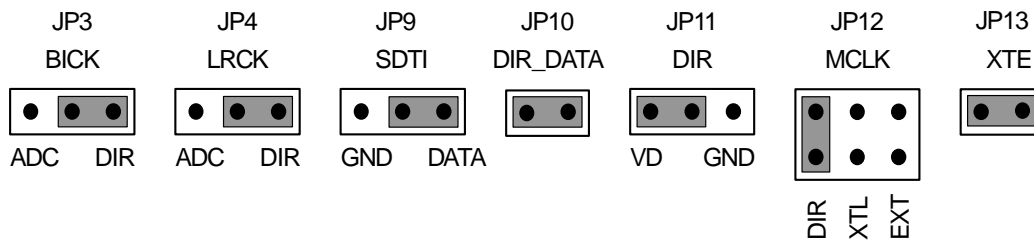

2) Ideal sine wave generated by ROM data

Connect the AKD43XX with PORT2(ADC/ROM). AKD4380 sends MCLK to AKD43XX, and receives LRCK, BICK and SDATA. In case of using external master clock through a BNC connector, select "BNC" on JP12(MCLK) and short JP13(XTE).

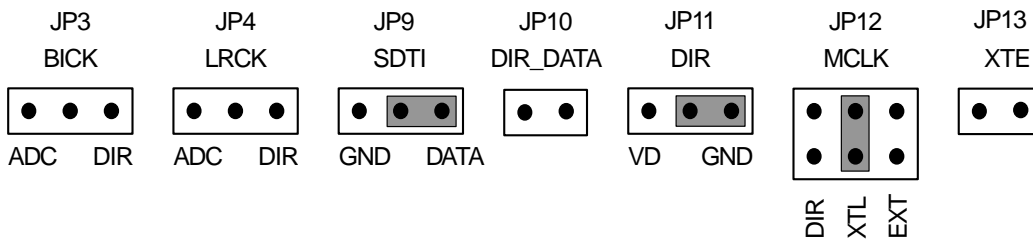

3) Using AKM’s evaluation board for ADC

To evaluate AK4380 with analog input, the AKM’s evaluation board for ADC can be used. MCLK, BICK and LRCK are supplied from clock generator on the AKD4380, and analog signal is A/D converted and send to AKD4380 through PORT2(ADC/ROM). In case of using external master clock through a BNC connector, select “BNC” on JP12(MCLK) and short JP13(XTE).

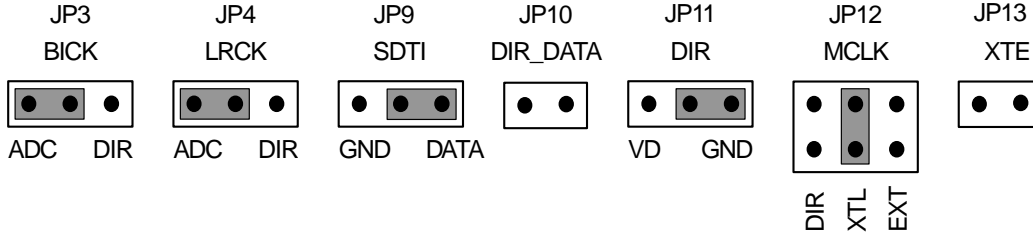

4) Feeding all signals from external

Under the following set-up, all external signals can be fed through POTR2.

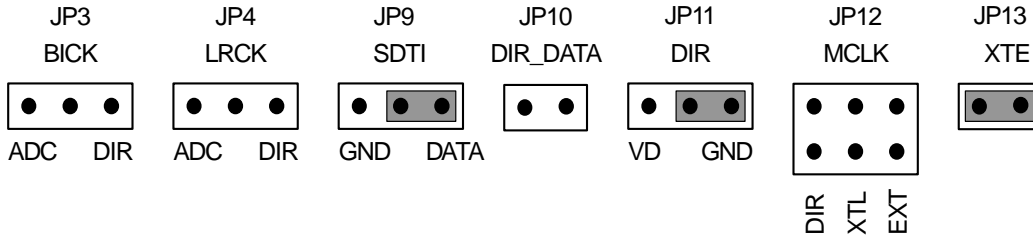

■ Clock (MCLK,BICK,LRCK) set up

In case of using evaluation mode 1), JP9,10 and 17 should be set up as follows. They need no care for other evaluation mode.

MCLK	JP5 (X_MCLK)	JP8 (X_LRCK)	BICK	JP7 (X_BICK)	
128fs	256/128	LR_128	32fs 64fs	64fs/32fs 128fs/64fs	default
256fs	256/128	LR_256/512	32fs 64fs 128fs	32fs 64fs/32fs 128fs/64fs	
512fs	512	LR_256/512	32fs 64fs 128fs	32fs 64fs/32fs 128fs/64fs	

Table 1. Clock set up

■ **DIP switch set up**

[SW4](MODE1): No.1 to 2 set the mode of AK4380 and No.3 to 5 set the mode of CS8414.

No.	Pin	OFF	ON
1	DFS0	Normal speed	Double speed
2	DIF0	24bit, MSB justified	I2S
3	M2	Digital interface format of CS8414 (See table 4.) (Note)	
4	M1		
5	M0		

Table 2. SW3 set-up

(Note: M2-0 should be selected at only evaluation mode 1.
In other mode, these should be "OFF".)

Mode	Format	3	4	5	6	7	8	JP6
		DIF0	DIF1	DIF2	M2	M1	M0	BICK2
0	16bit, LSB justified	0	0	0	1	0	1	THR
1	20bit, LSB justified	1	0	0	-	-	-	-
2	24bit, MSB justified	0	1	0	0	0	0	INV
3	I2S	1	1	0	0	1	0	THR
4	24bit, LSB justified	0	0	1	-	-	-	-

default

Table 3. Digital interface format set-up (1=ON, 0=OFF)
(CS8414 does not correspond to 20/24bit LSB justified format.)

■ **Other jumper pins set up**

[JP1] (GND): Analog ground and digital ground
open: separated <default>
short: AGND and DGND are connected.

[JP2] (DZF) Mute circuit
ON: Used . Analog output are muted when DZF="H".
OFF: Not used. <default>

[JP6] (BICK_ PHASE): Phase of BCLK
THR: BICK is coincides with AK4380. <default>
INV: BICK is inverted.

■ **The function of the toggle SW.**

[SW1](PDN): Resets the AK4380. Keep "H" during normal operation.
[SW2](SMUTE): Soft mute of AK4380. Bring "H" when using soft mute.
[SW3](P/S): H: parallel mode.
L: serial mode.

■ **Indication for LED**

[LED1] (VERF): Monitor VERF pin of the CS8414. LED turns on when some error has occurred to CS8414.
[LED2]: (PREM): Indicate whether the input data of CS8414 is pre-emphasized or not.

■ **Serial control mode**

The AK4380 can be controlled via the printer port (parallel port) of IBM-AT compatible PC. Connect PORT1(up-I/F) with PC by 10-line flat cable packed with the AKD4380.

Take care of the direction of connector. There is a mark at 1pin.
The pin layout of PORT1 is as Figure 2.

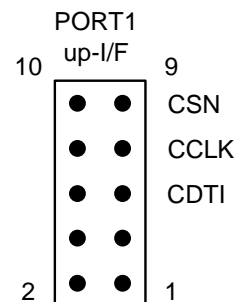

Figure 2. PORT1 pin layout

MEASUREMENT RESULTS

[Measurement condition]

- Measurement unit: Audio Precision System Two Cascade
- MCLK : 256fs
- BICK : 64fs
- fs : 44.1kHz, 96kHz
- BW : 10Hz~20kHz (fs=44.1kHz), 10Hz~40kHz (fs=96kHz)
- Bit : 24bit
- Power Supply : VDD=5V
- Interface : DIR (fs=44.1kHz, 96kHz)
- Temperature : Room

Parameter	Input signal	Measurement filter	fs=44.1kHz
S/(N+D)	1kHz, 0dB	20kLPF	94.0dB
DR	1kHz, -60dB	22kLPF	97.2dB
		22kLPF, A-weighted	100.0dB
S/N	no signal	22kLPF	97.2dB
		22kLPF, A-weighted	100.0dB

Parameter	Input signal	Measurement filter	fs=96kHz
S/(N+D)	1kHz, 0dB	40kLPF	92.3dB
DR	1kHz, -60dB	40kLPF	94.5dB
		22kLPF, A-weighted	97.2dB
S/N	no signal	40kLPF	94.5dB
		22kLPF, A-weighted	97.2dB

(fs=44.1kHz)

AKM

AK4380 Rev.A FFT (Input=0dBFS, fin=1kHz)

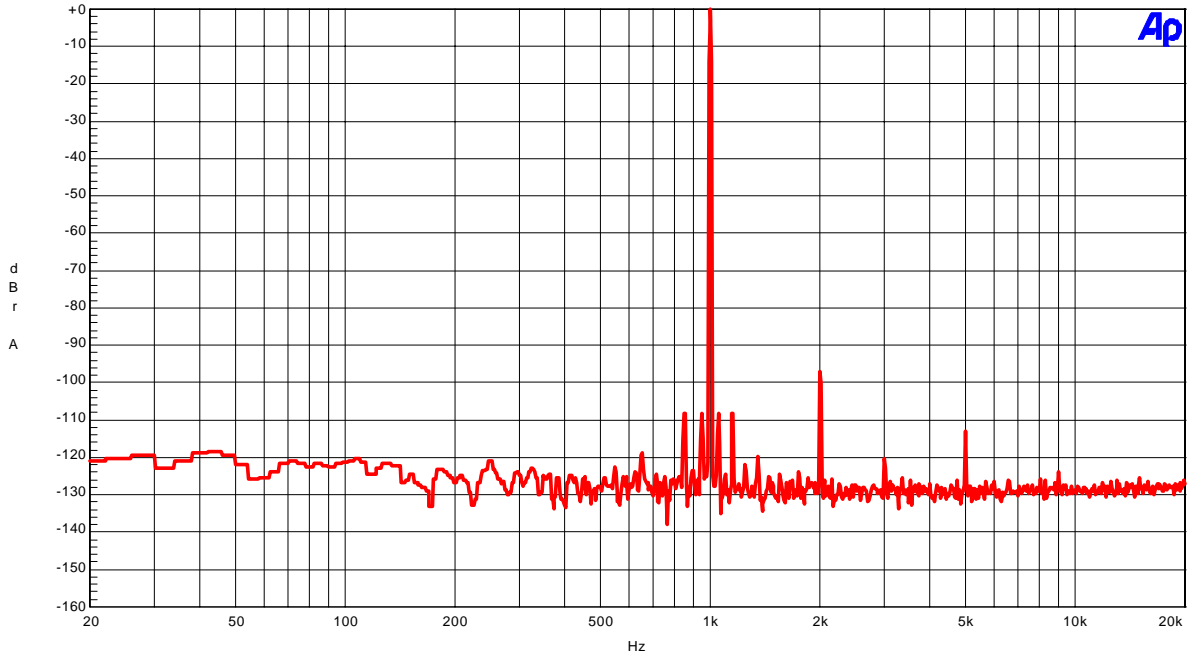

AKM

AK4380 Rev.A FFT (Input=-60dBFS, fin=1kHz)

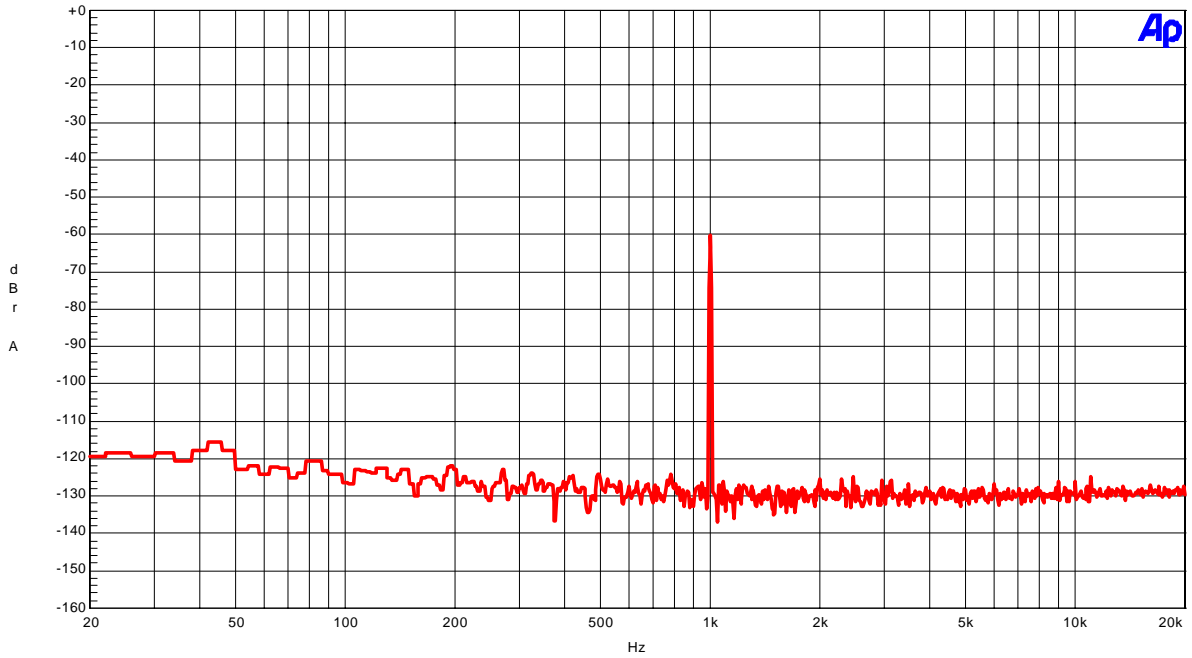

AKM (fs=44.1kHz)
AK4380 Rev.A FFT (Input="0"data, fin=1kHz)

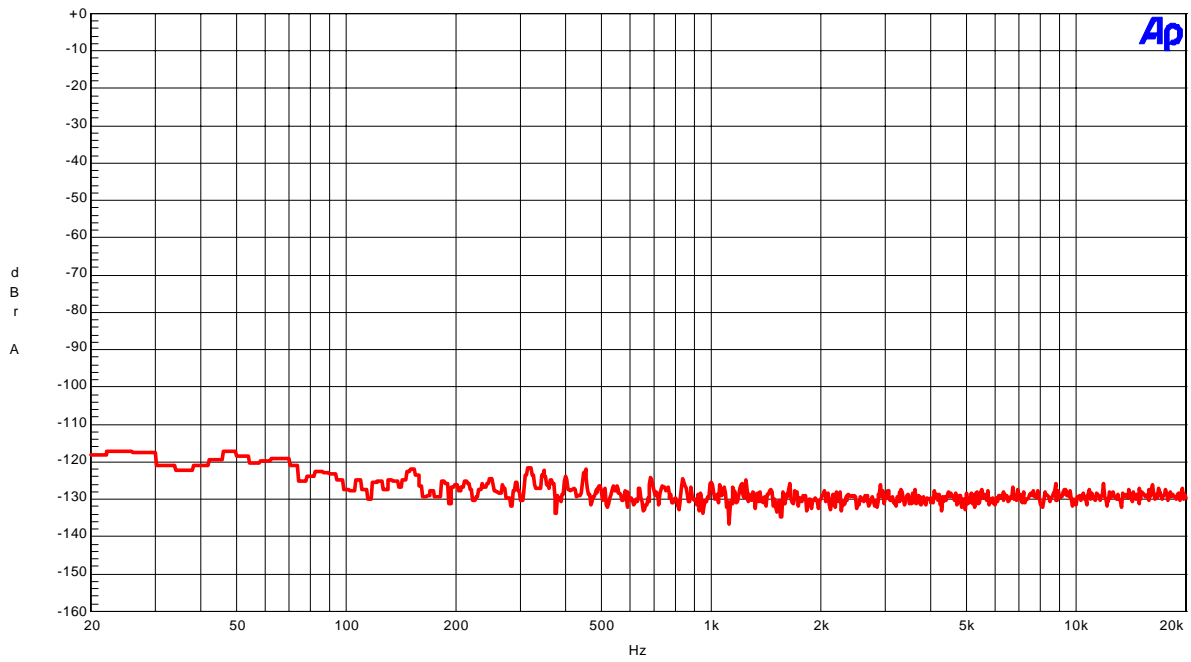

AKM AK4380 Rev.A FFT (Input="0"data, fin=1kHz, HiBW)

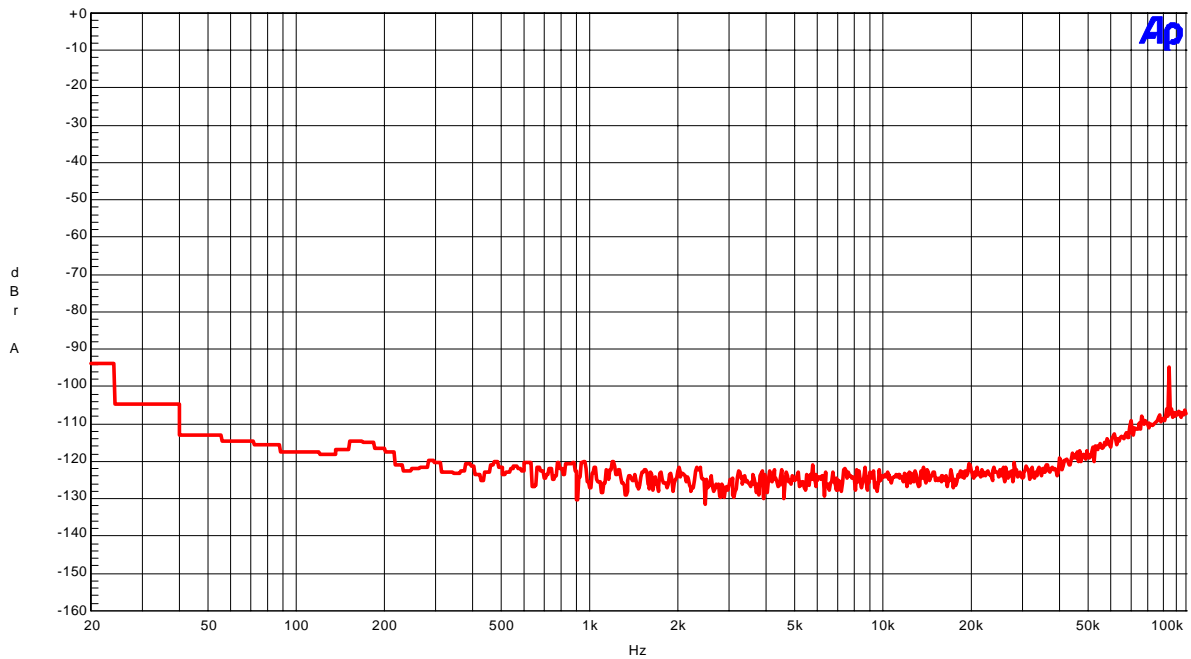

AKM (fs=44.1kHz)
AK4380 Rev.A THD + N vs Amplitude (fin=1kHz)

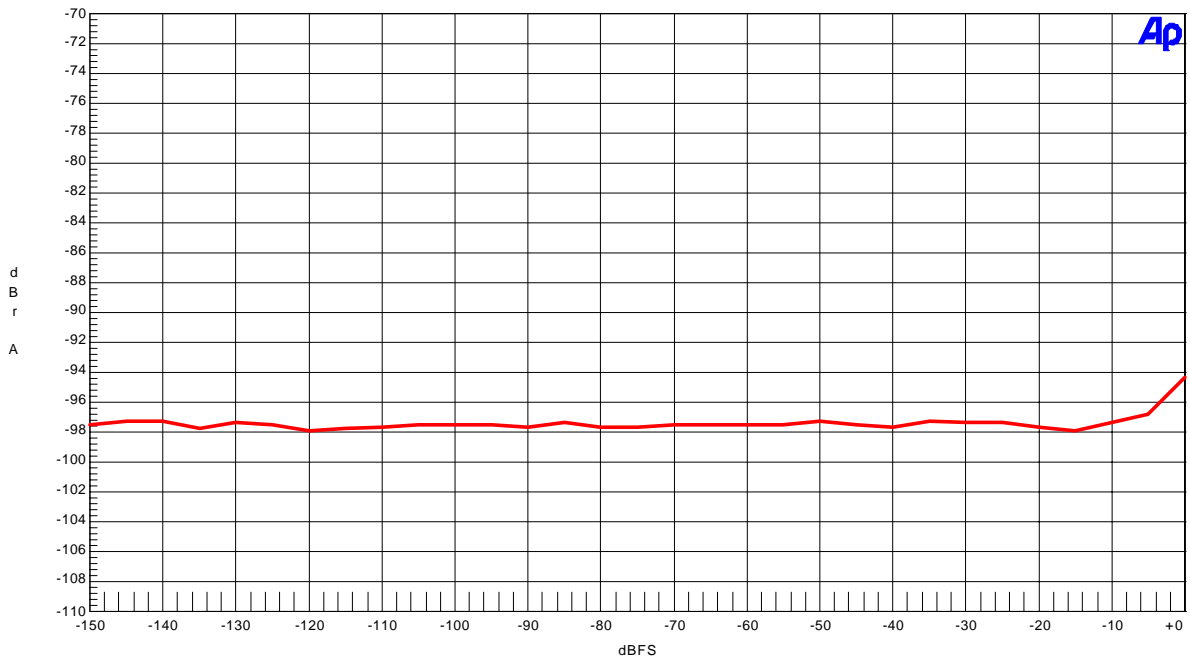

AKM AK4380 Rev.A THD + N vs Input Frequency (fin=1kHz)

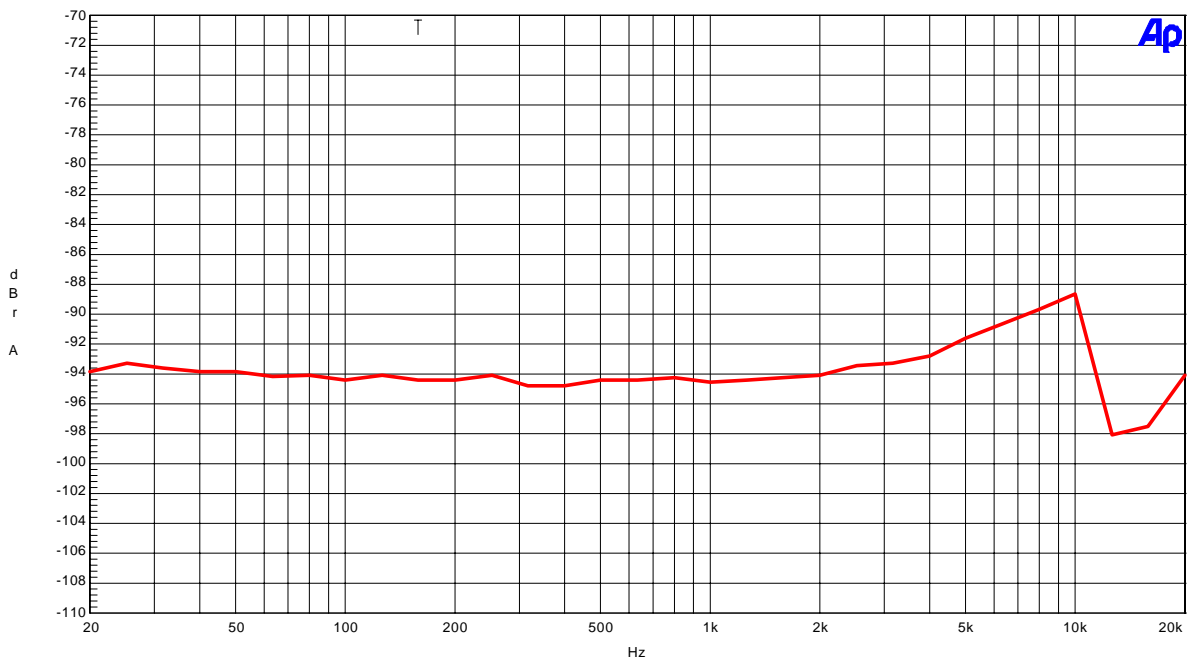

AKM

AK4380 Rev.A Linearity

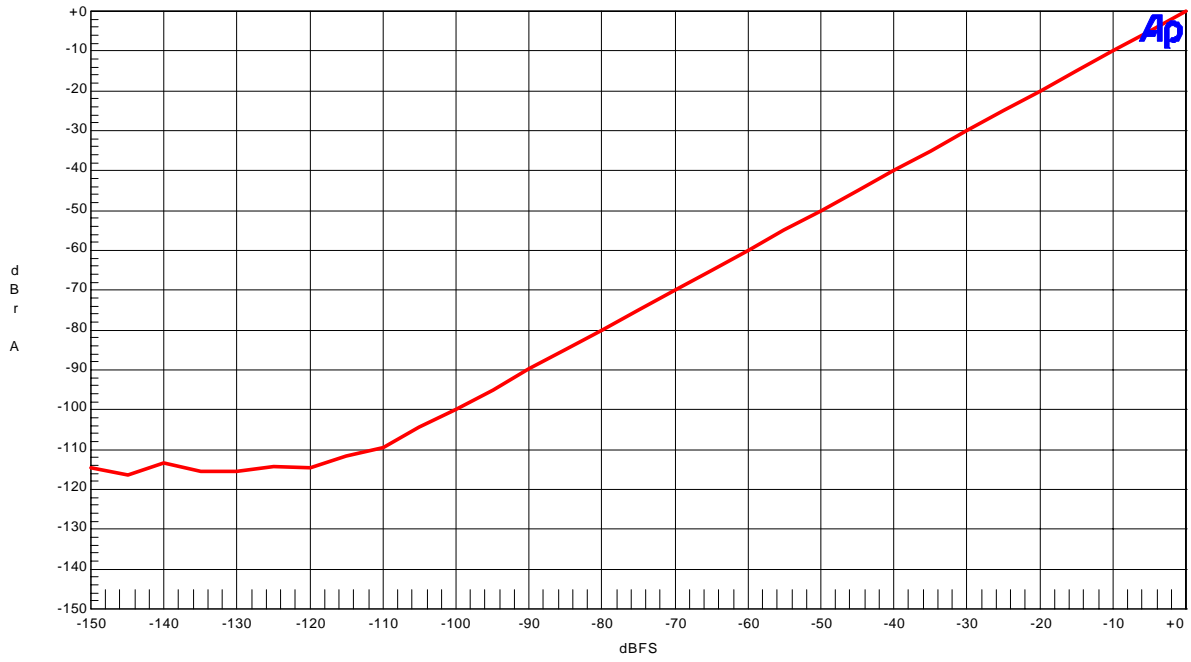

AKM

AK4380 Rev.A Frequency Response

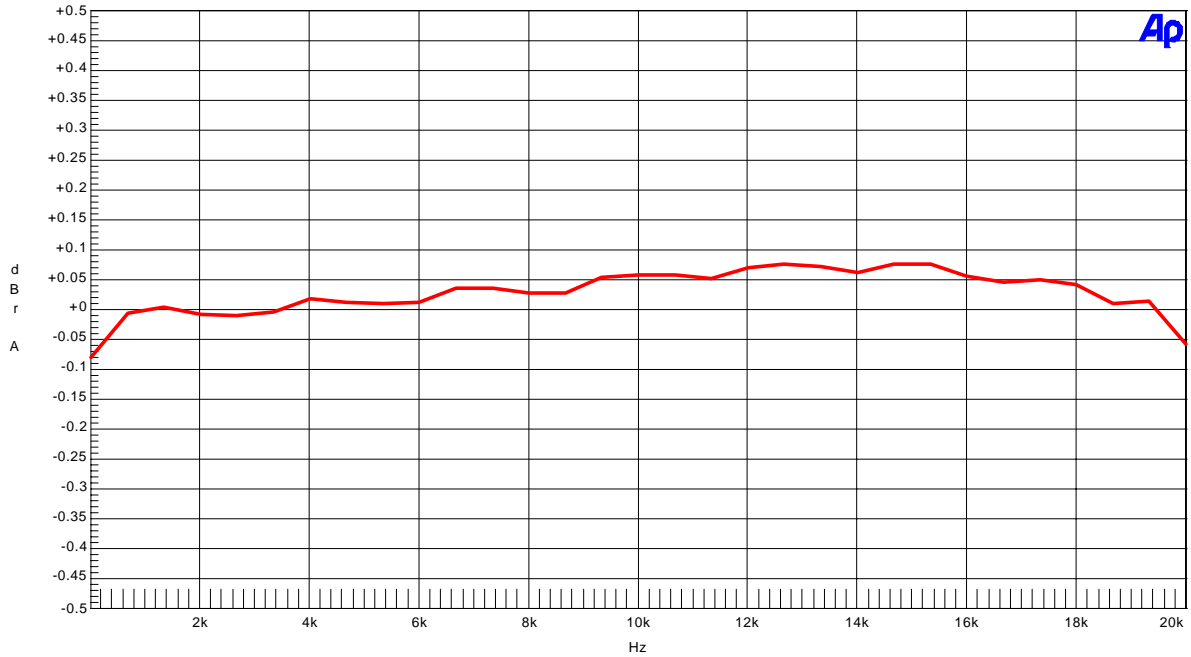

(fs=44.1kHz)

AKM

AK4380 Rev.A Crosstalk

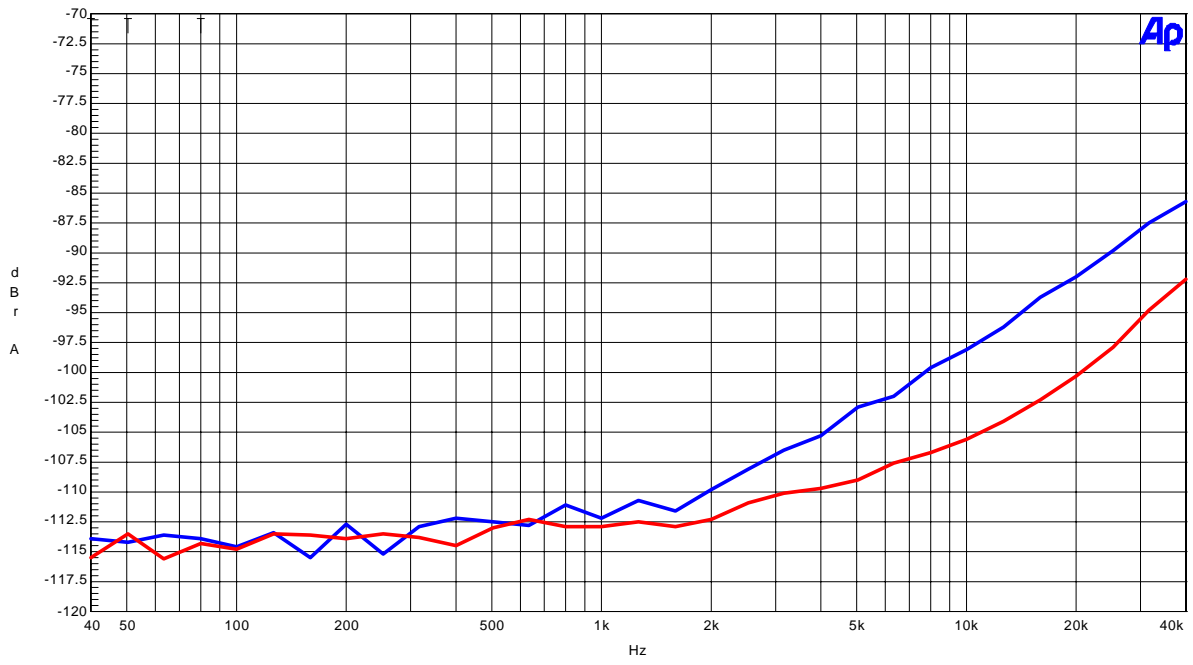

(fs=96kHz)

AKM

AK4380 Rev.A FFT (Input=0dBFS,fin=1kHz)

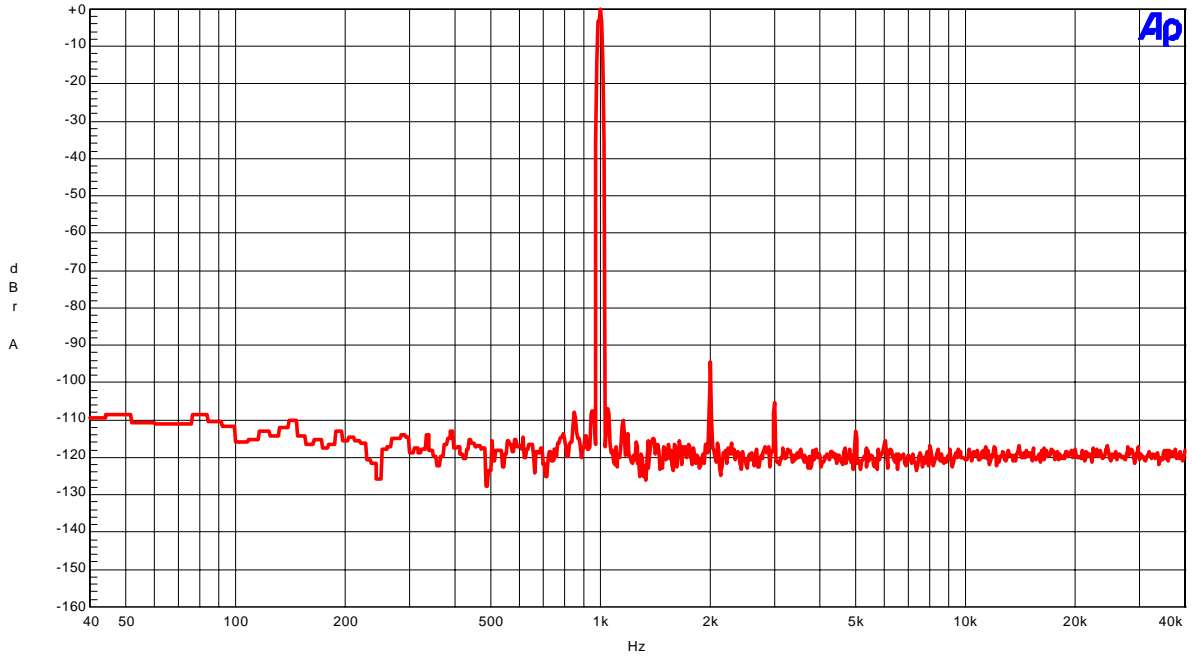

AKM

AK4380 Rev.A FFT (Input=-60dBFS,fin=1kHz)

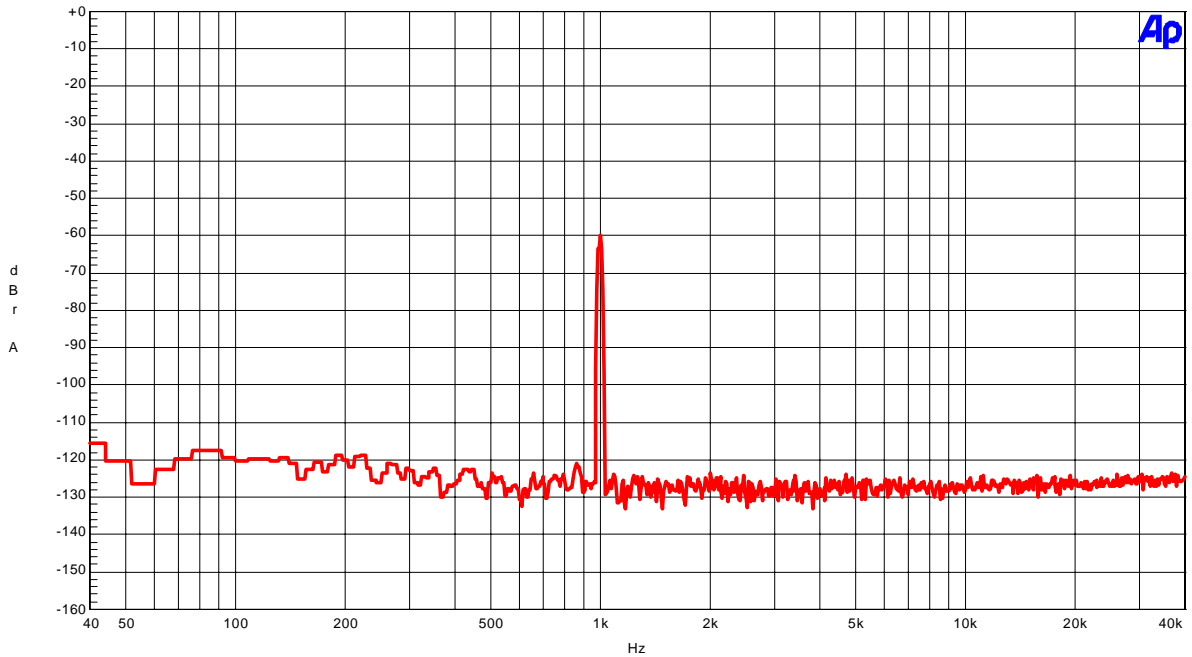

(fs=96kHz)

AKM

AK4380 Rev.A FFT (Input="0"data,fin=1kHz)

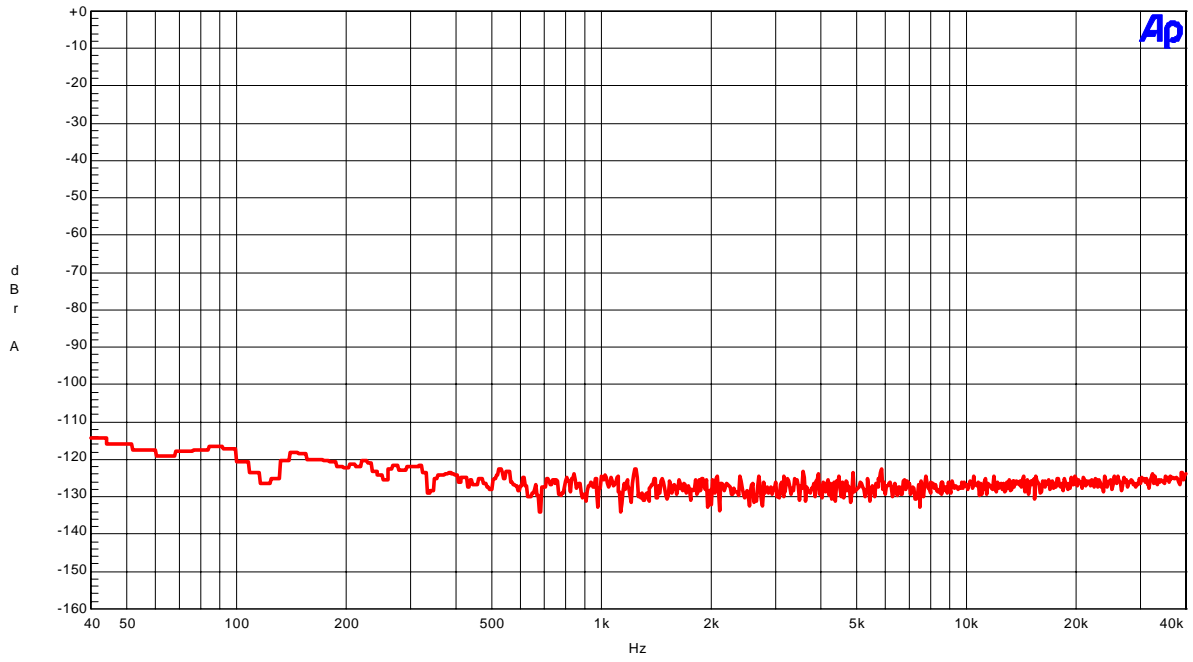

(fs=96kHz)

AKM

AK4380 Rev.A THD + N vs Amplitude(fin=1kHz)

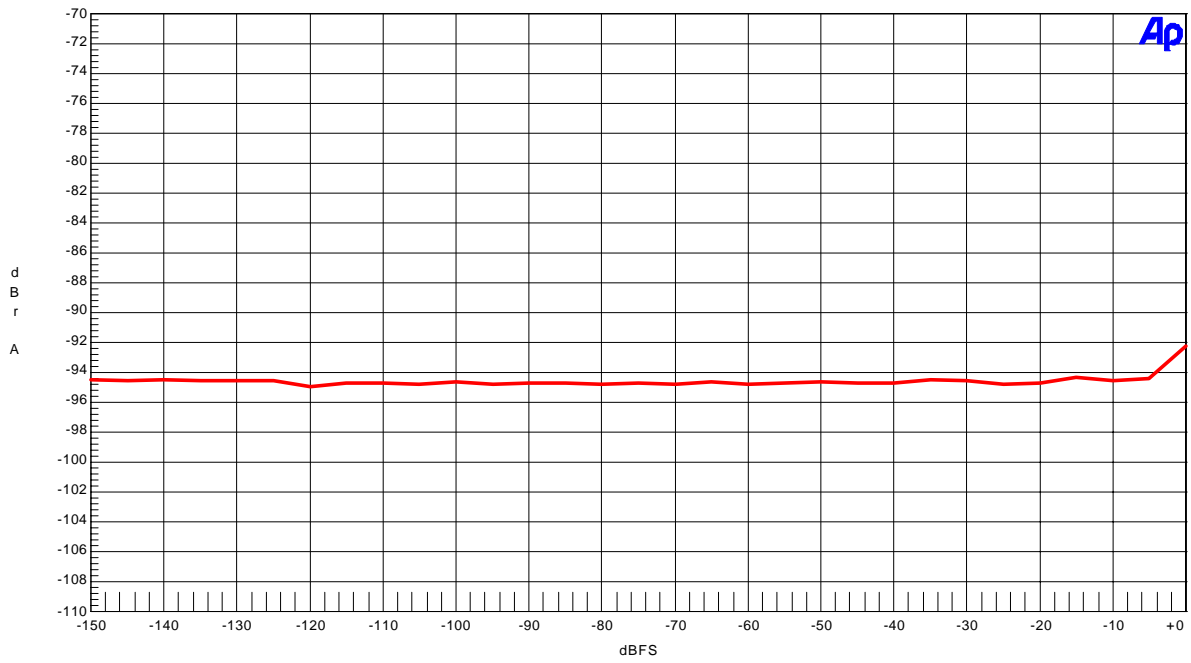

AKM

AK4380 Rev.A THD + N vs Input Frequency(Input=0dBFS)

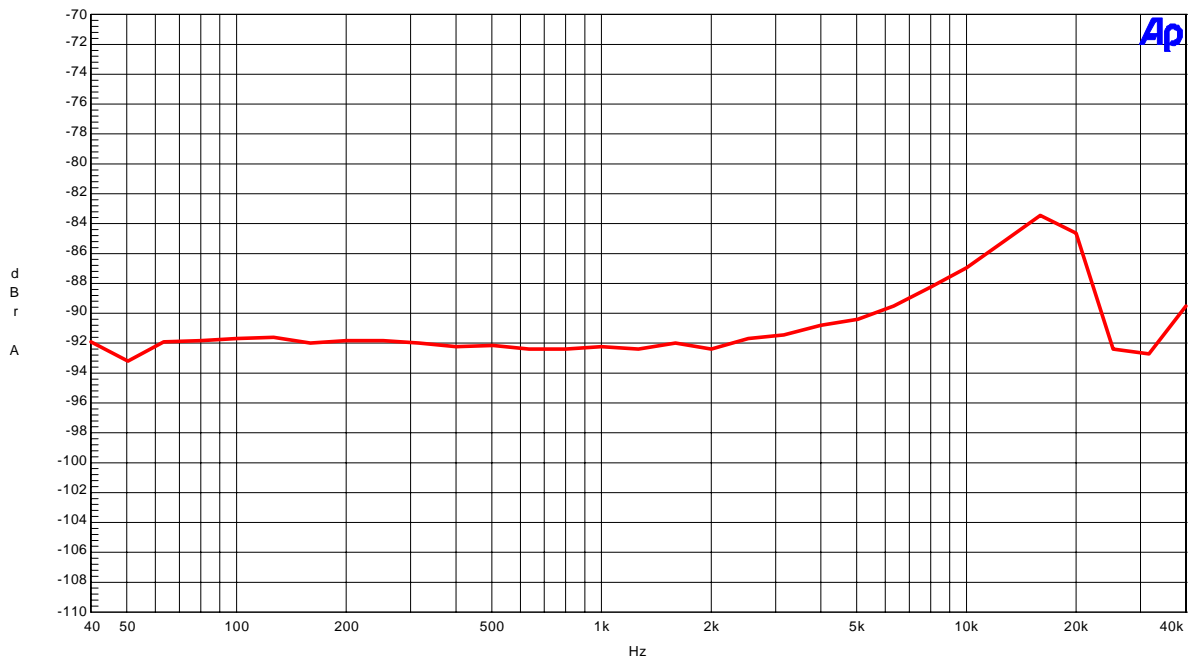

(fs=96kHz)

AKM

AK4380 Linearity

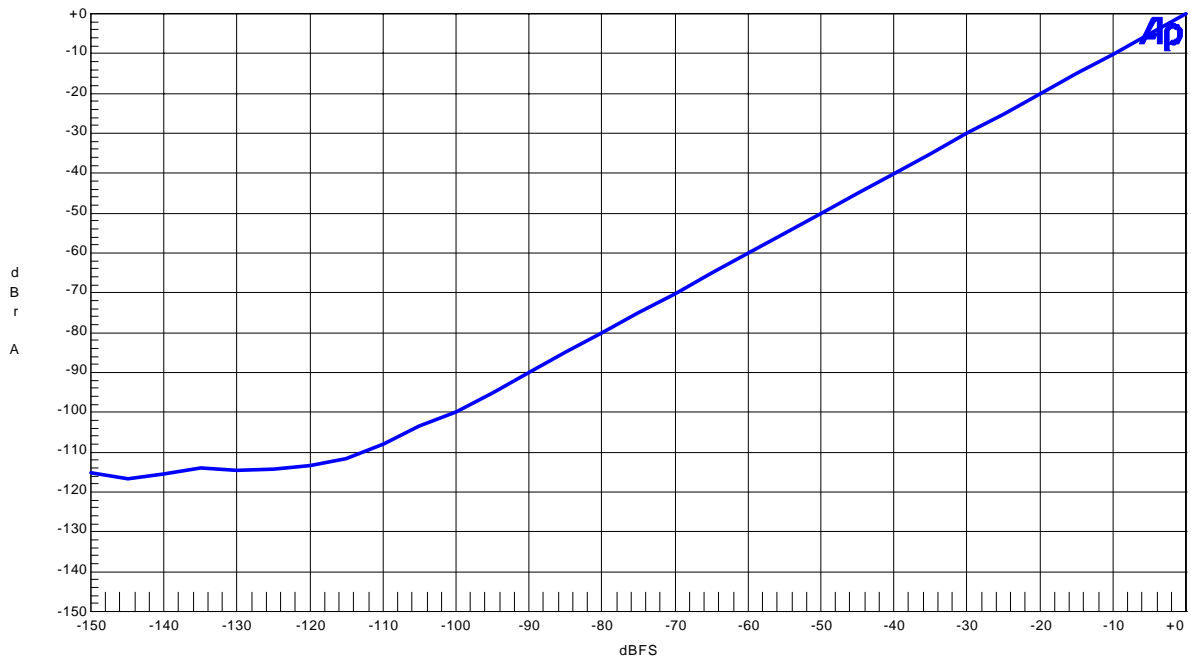

AKM

AK4380 Rev.A Frequency Response

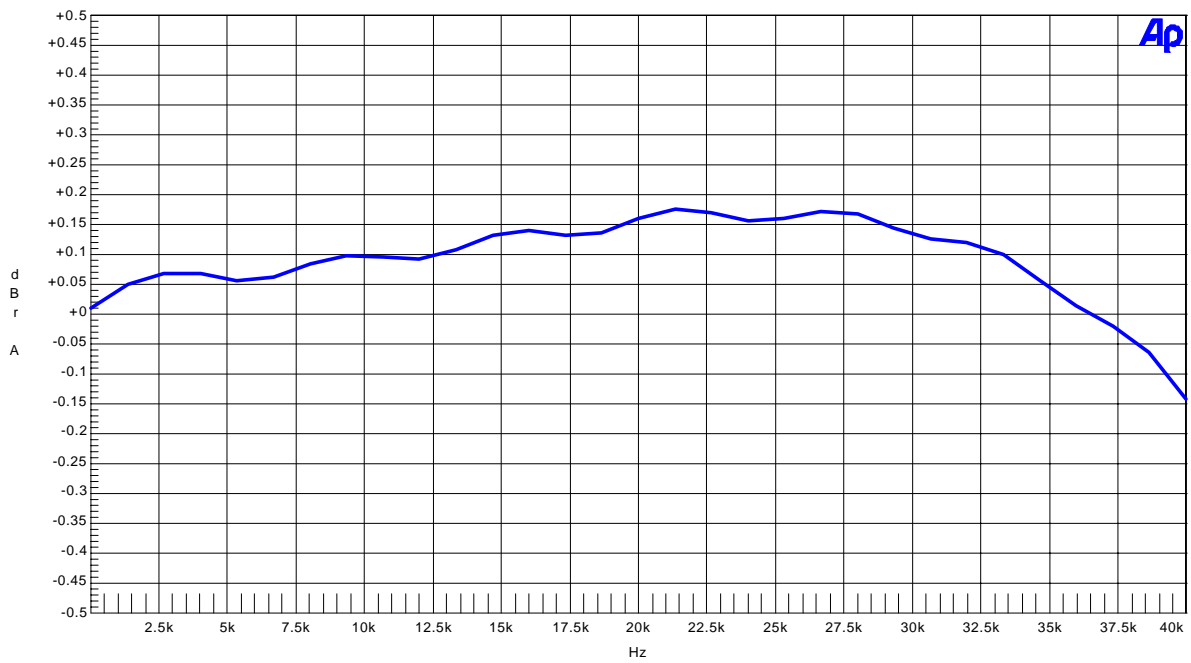

AKM

AK4380 Rev.A Crosstalk

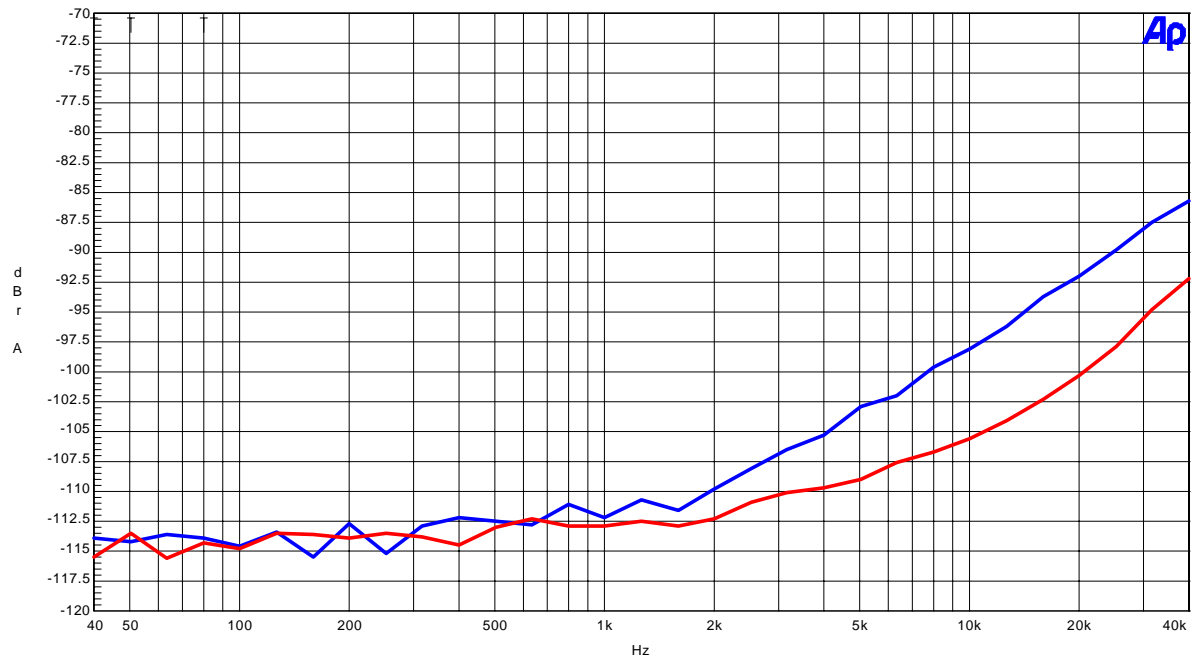

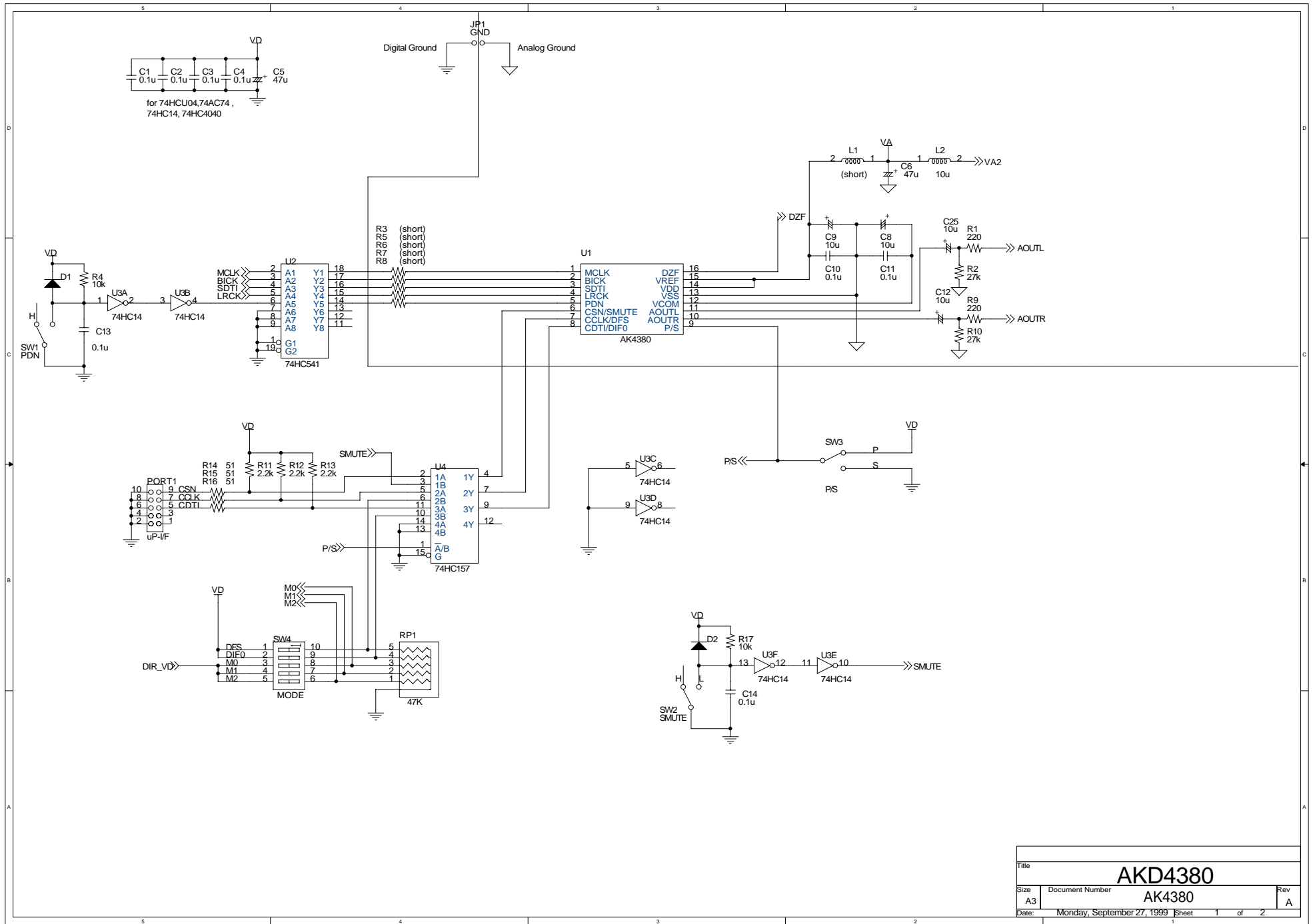

Title		
AKD4380		
Size	Document Number	Rev
A3	AK4380	A
Date:	Monday, September 27, 1999	Sheet 1 of 2

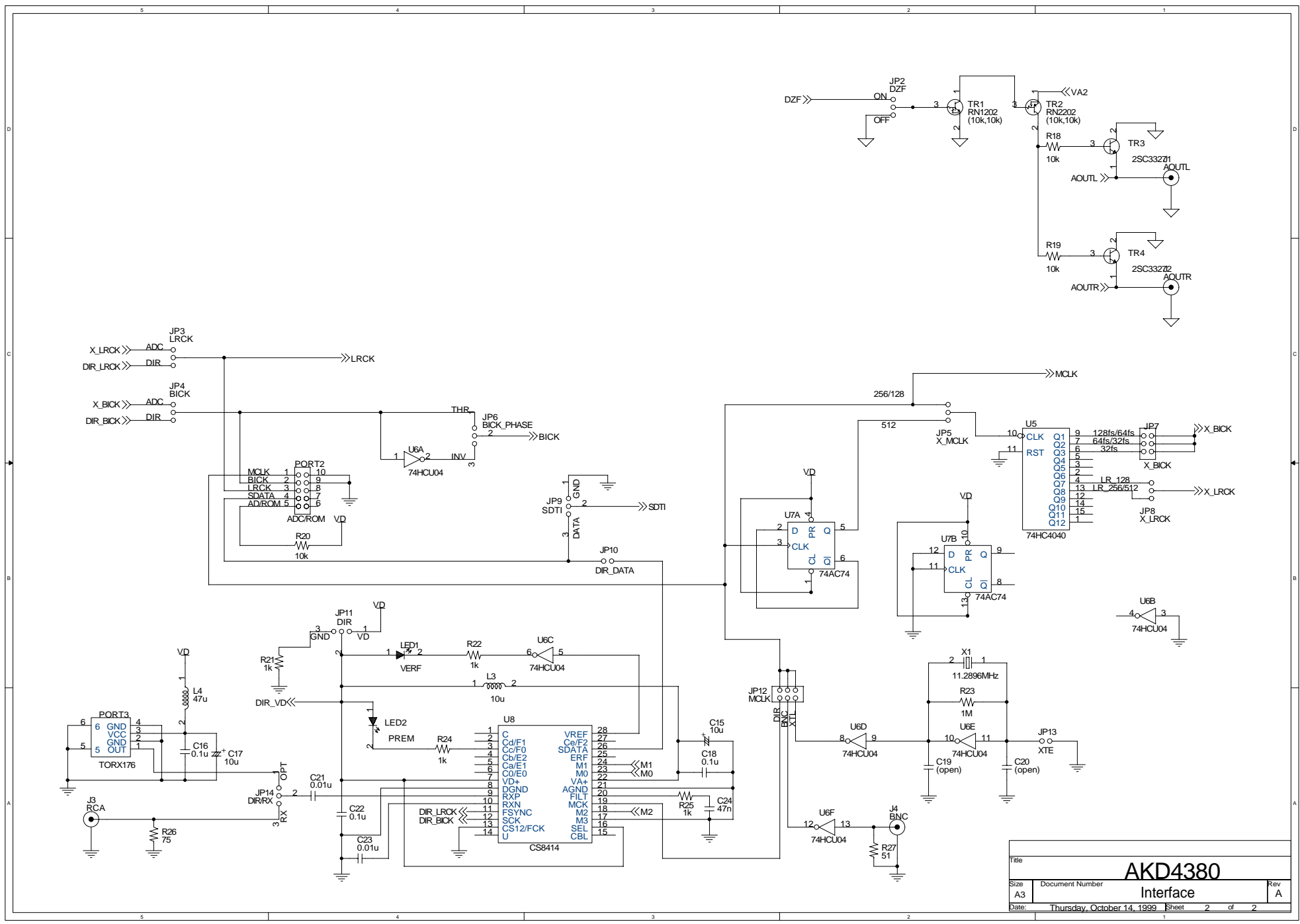

Title			AKD4380		
Size					
A3	Document Number	Interface			Rev
Date:		Thursday, October 14, 1999	Sheet	2	of 2

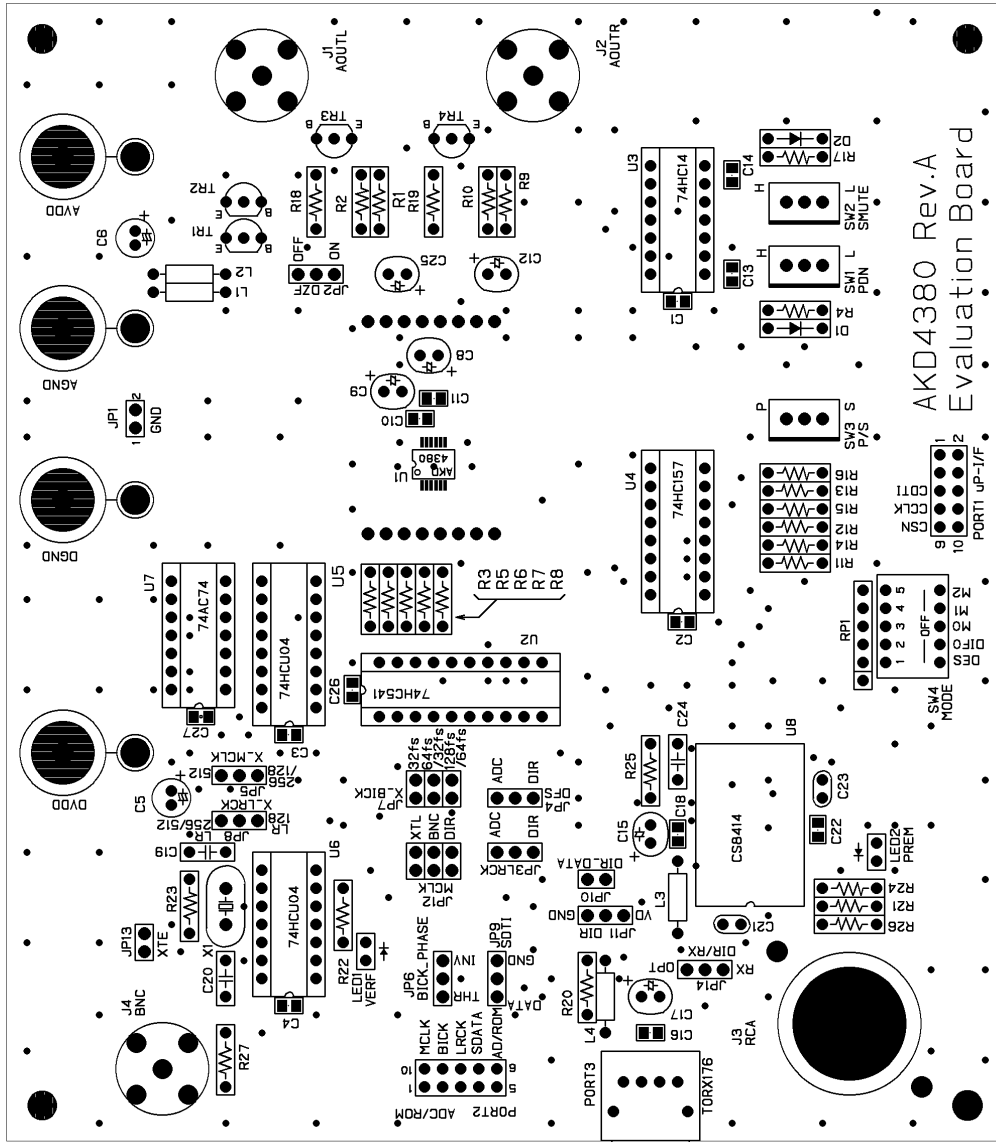

AKD4380 Rev.A
Evaluation Board

L1 部品面 シルク レジスト AKD4380

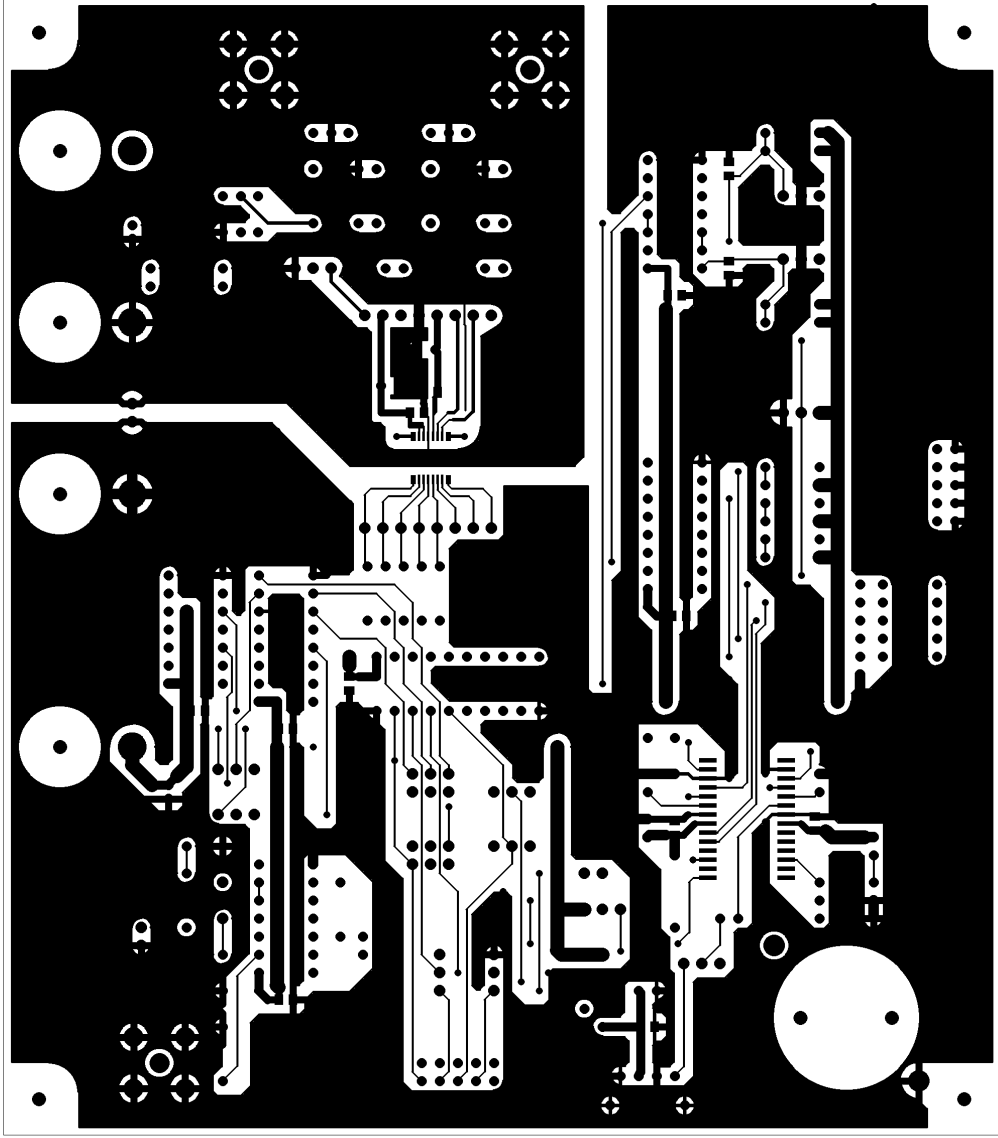

L1 部品面 パターン AKD4380

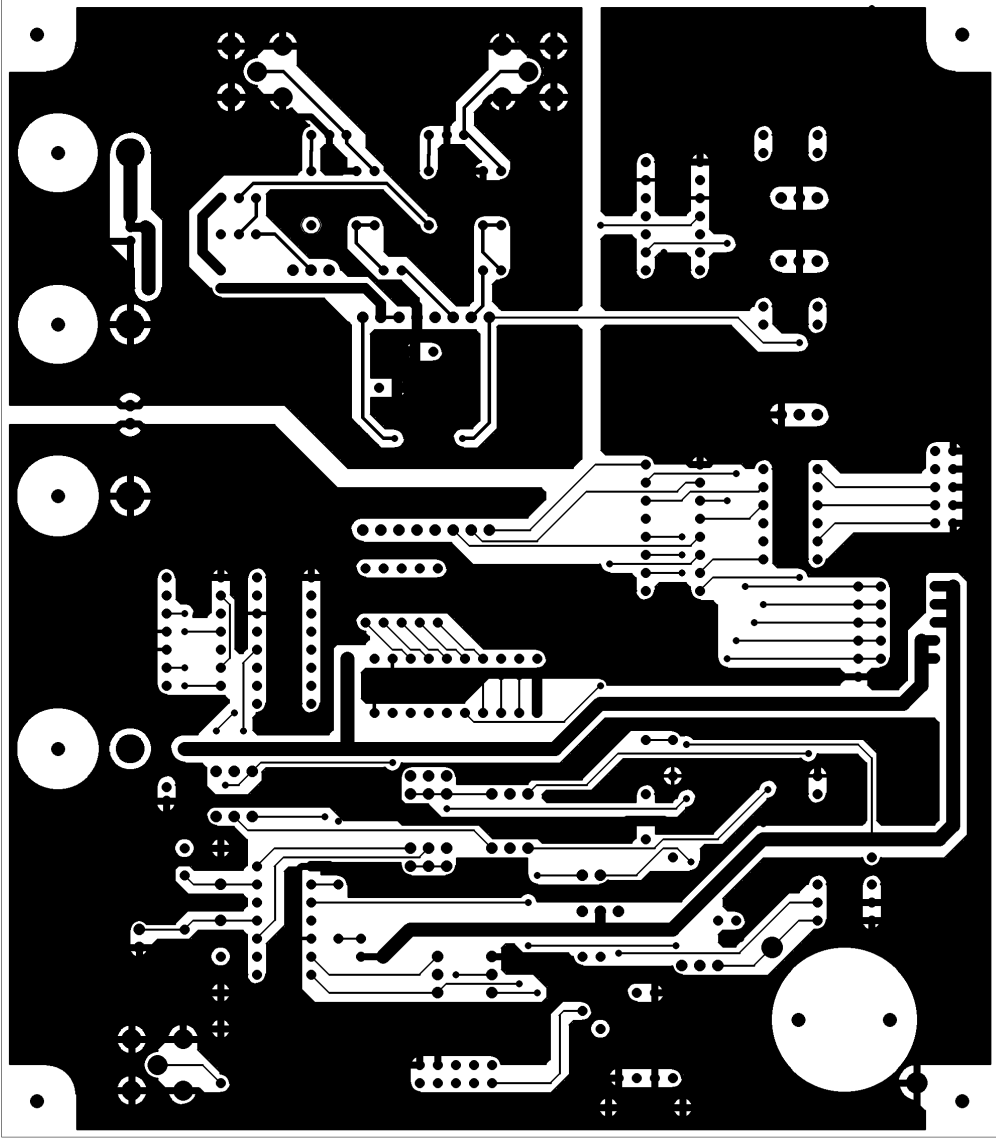

「S」未田面 1/2-2

YKD4380

IMPORTANT NOTICE

- These products and their specifications are subject to change without notice. Before considering any use or application, consult the Asahi Kasei Microsystems Co., Ltd. (AKM) sales office or authorized distributor concerning their current status.
- AKM assumes no liability for infringement of any patent, intellectual property, or other right in the application or use of any information contained herein.
- Any export of these products, or devices or systems containing them, may require an export license or other official approval under the law and regulations of the country of export pertaining to customs and tariffs, currency exchange, or strategic materials.
- AKM products are neither intended nor authorized for use as critical components in any safety, life support, or other hazard related device or system, and AKM assumes no responsibility relating to any such use, except with the express written consent of the Representative Director of AKM. As used here:
 - (a) A hazard related device or system is one designed or intended for life support or maintenance of safety or for applications in medicine, aerospace, nuclear energy, or other fields, in which its failure to function or perform may reasonably be expected to result in loss of life or in significant injury or damage to person or property.
 - (b) A critical component is one whose failure to function or perform may reasonably be expected to result, whether directly or indirectly, in the loss of the safety or effectiveness of the device or system containing it, and which must therefore meet very high standards of performance and reliability.
- It is the responsibility of the buyer or distributor of an AKM product who distributes, disposes of, or otherwise places the product with a third party to notify that party in advance of the above content and conditions, and the buyer or distributor agrees to assume any and all responsibility and liability for and hold AKM harmless from any and all claims arising from the use of said product in the absence of such notification.