



# PD55008 PD55008S

## RF POWER TRANSISTORS The LdmoST Plastic FAMILY

### N-CHANNEL ENHANCEMENT-MODE LATERAL MOSFETs

- EXCELLENT THERMAL STABILITY
- COMMON SOURCE CONFIGURATION
- $P_{OUT} = 8\text{ W}$  with 17 dB gain @ 500 MHz / 12.5V
- NEW RF PLASTIC PACKAGE

#### DESCRIPTION

The PD55008 is a common source N-Channel, enhancement-mode lateral Field-Effect RF power transistor. It is designed for high gain, broad band commercial and industrial applications. It operates at 12 V in common source mode at frequencies up to 1 GHz.

PD55008 boasts the excellent gain, linearity and reliability of ST's latest LDMOS technology mounted in the first true SMD plastic RF power package, PowerSO-10RF. PD55008's superior linearity performance makes it an ideal solution for car mobile radio.

The PowerSO-10 plastic package, designed to offer high reliability, is the first ST JEDEC approved, high power SMD package. It has been specially optimized for RF needs and offers excellent RF performances and ease of assembly.

*Mounting recommendations are available in [www.st.com/rf/](http://www.st.com/rf/) (look for application note AN1294)*

#### ABSOLUTE MAXIMUM RATINGS ( $T_{CASE} = 25^{\circ}\text{C}$ )

Symbol	Parameter	Value	Unit
$V_{(BR)DSS}$	Drain-Source Voltage	40	V
$V_{GS}$	Gate-Source Voltage	$\pm 20$	V
$I_D$	Drain Current	4	A
$P_{DISS}$	Power Dissipation (@ $T_c = 70^{\circ}\text{C}$ )	52.8	W
$T_j$	Max. Operating Junction Temperature	165	$^{\circ}\text{C}$
$T_{STG}$	Storage Temperature	-65 to +150	$^{\circ}\text{C}$

#### THERMAL DATA

$R_{th(j-c)}$	Junction -Case Thermal Resistance	1.8	$^{\circ}\text{C}/\text{W}$
---------------	-----------------------------------	-----	-----------------------------

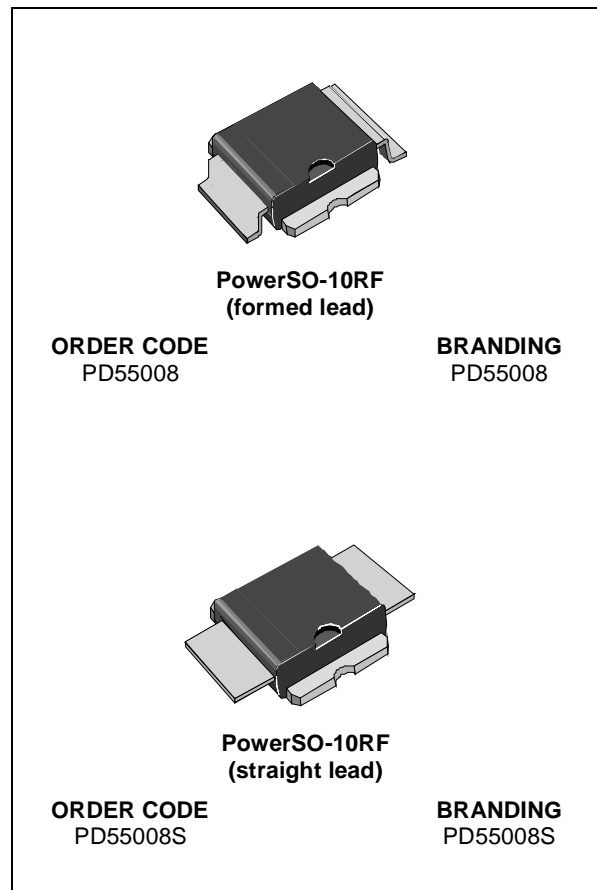

# PD55008 - PD55008S

## ELECTRICAL SPECIFICATION (T<sub>CASE</sub> = 25°C)

### STATIC

Symbol	Test Conditions		Min.	Typ.	Max.	Unit
I <sub>DSS</sub>	V <sub>GS</sub> = 0 V	V <sub>DS</sub> = 28 V			1	μA
I <sub>GSS</sub>	V <sub>GS</sub> = 20 V	V <sub>DS</sub> = 0 V			1	μA
V <sub>GS(Q)</sub>	V <sub>DS</sub> = 10 V	I <sub>D</sub> = 150 mA	2.0		5.0	V
V <sub>DS(ON)</sub>	V <sub>GS</sub> = 10 V	I <sub>D</sub> = 1.5 A			0.67	V
g <sub>FS</sub>	V <sub>DS</sub> = 10 V	I <sub>D</sub> = 1.5 A		1.6		mho
C <sub>ISS</sub>	V <sub>GS</sub> = 0 V	V <sub>DS</sub> = 12.5 V		58		pF
C <sub>OSS</sub>	V <sub>GS</sub> = 0 V	V <sub>DS</sub> = 12.5 V		38		pF
C <sub>RSS</sub>	V <sub>GS</sub> = 0 V	V <sub>DS</sub> = 12.5 V		2.8		pF

### DYNAMIC

Symbol	Test Conditions		Min.	Typ.	Max.	Unit
P <sub>OUT</sub>	V <sub>DD</sub> = 12.5 V	I <sub>DQ</sub> = 150 mA f = 500 MHz	8			W
G <sub>P</sub>	V <sub>DD</sub> = 12.5 V	I <sub>DQ</sub> = 150 mA P <sub>OUT</sub> = 8 W f = 500 MHz	15	17		dB
η <sub>D</sub>	V <sub>DD</sub> = 12.5 V	I <sub>DQ</sub> = 150 mA P <sub>OUT</sub> = 8 W f = 500 MHz	50	55		%
Load mismatch	V <sub>DD</sub> = 15.5 V	I <sub>DQ</sub> = 150 mA P <sub>OUT</sub> = 8 W f = 500 MHz ALL PHASE ANGLES	20:1			VSWR

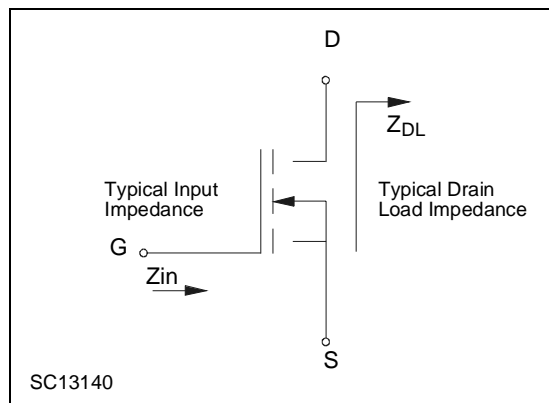
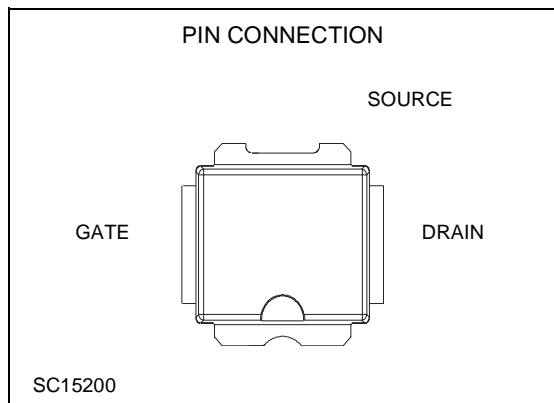

### IMPEDANCE DATA

PD55008

FREQ. MHz	Z <sub>IN</sub> (Ω)	Z <sub>DL</sub> (Ω)
480	1.141 - j 2.054	1.649 + j 2.916
500	1.589 - j 1.185	1.561 + j 2.639
520	1.649 - j 1.965	1.716 + j 1.552
800	1.05 + j 0.54	2.62 - j 1.91
850	1.50 + j 1.00	2.26 - j 1.54
900	1.95 + j 2.28	2.70 - j 1.90

PD55008S

FREQ. MHz	Z <sub>IN</sub> (Ω)	Z <sub>DL</sub> (Ω)
480	1.075 - j 2.727	2.046 + j 1.960
500	1.409 - j 3.448	2.129 + j 3.219
520	1.586 - j 2.087	3.082 + j 2.043

TYPICAL PERFORMANCE

Capacitance vs. Drain Voltage

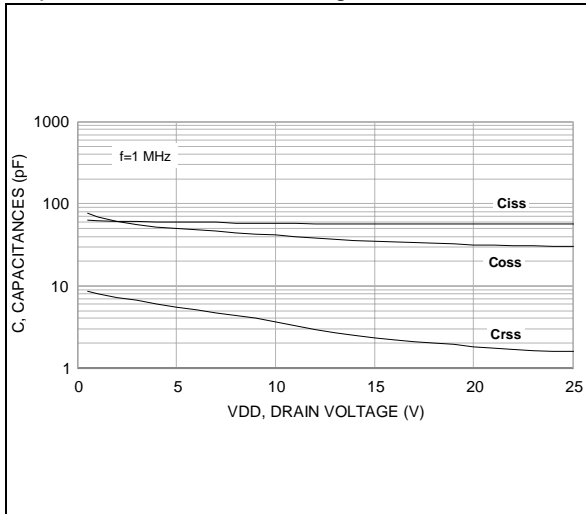

Drain Current vs. Gate-Source Voltage

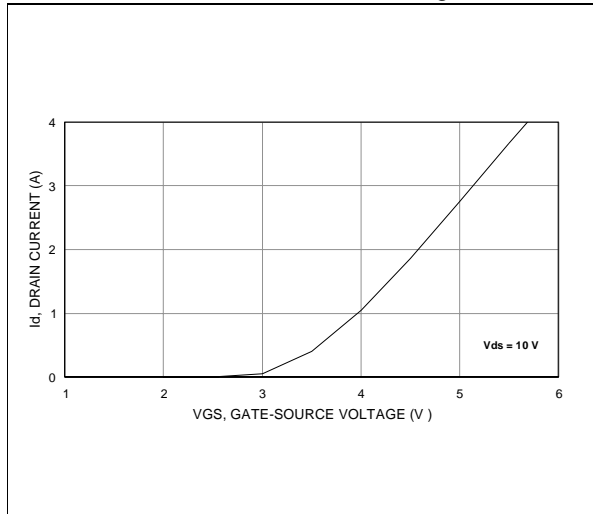

Gate-Source Voltage vs. Case Temperature

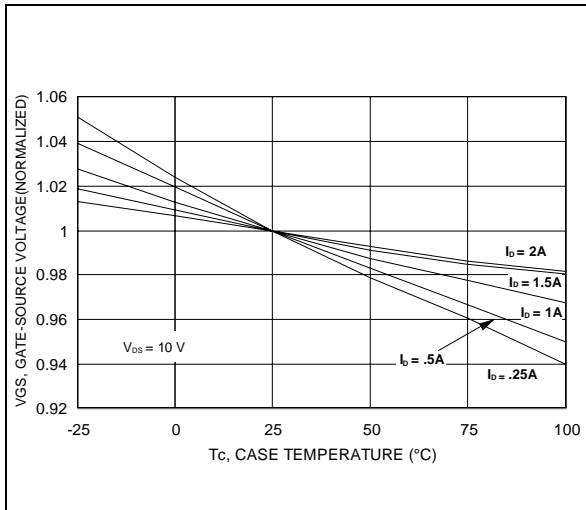

# PD55008 - PD55008S

## TYPICAL PERFORMANCE (PD55008)

### Output Power vs. Input Power

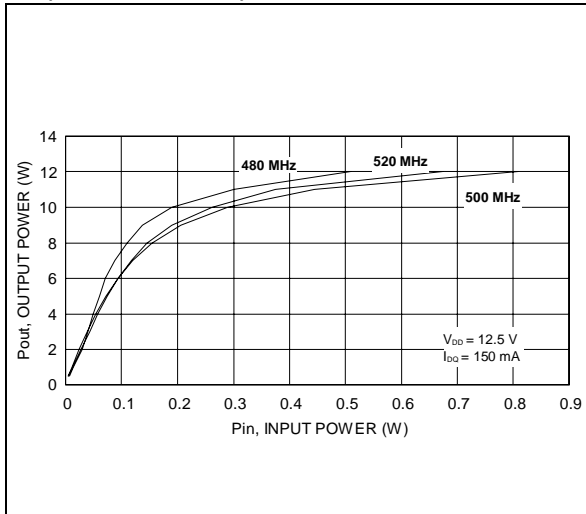

### Power Gain vs. Output Power

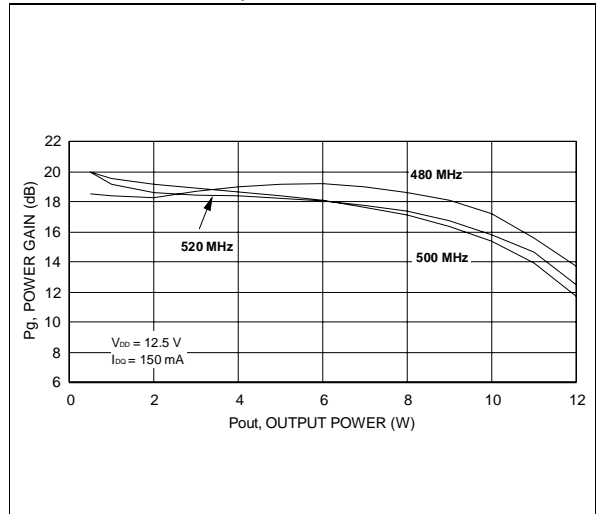

### Drain Efficiency vs. Output Power

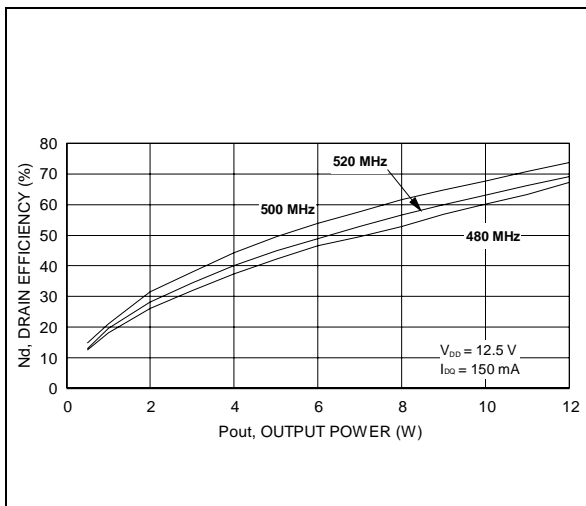

### Input Return Loss vs. Output Power

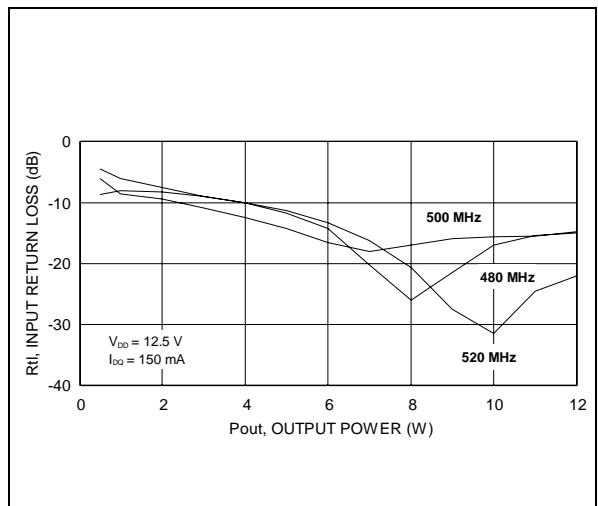

### Output Power vs. Bias Current

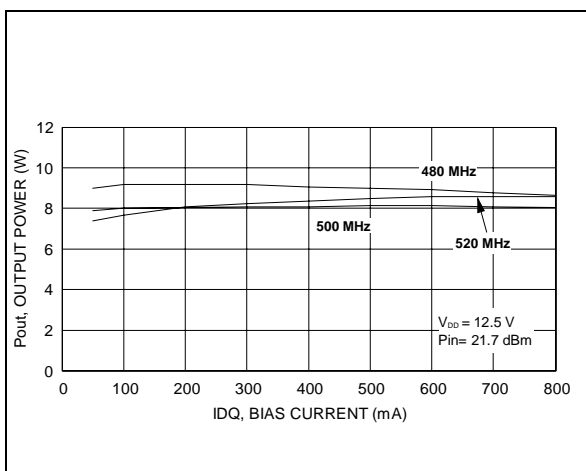

### Drain Efficiency vs. Bias Current

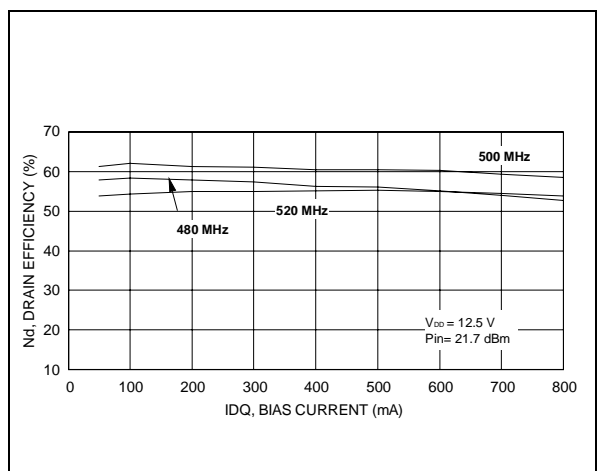

TYPICAL PERFORMANCE (PD55008)

Output Power vs. Supply Voltage

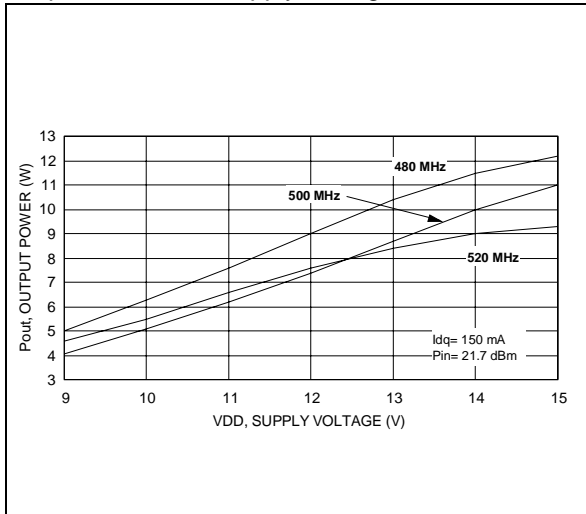

Drain Efficiency vs. Supply Voltage

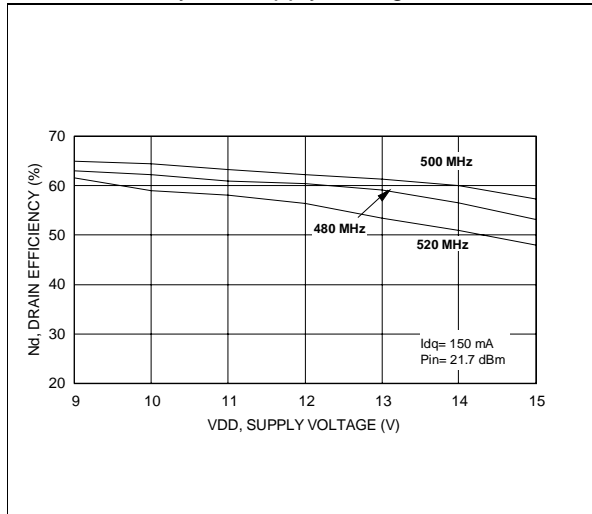

Output Power vs. Gate-Source Voltage

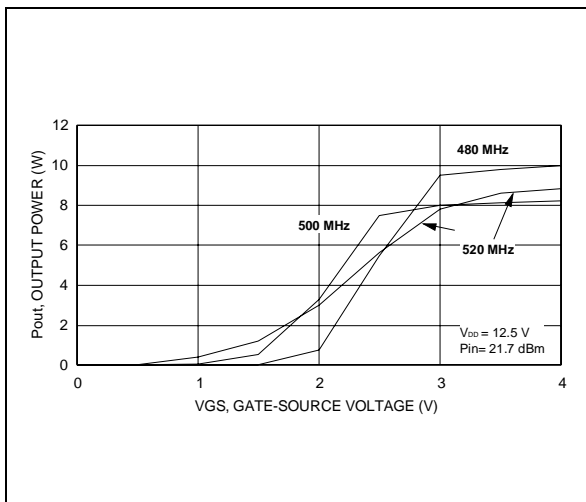

Output Power vs. Input Power

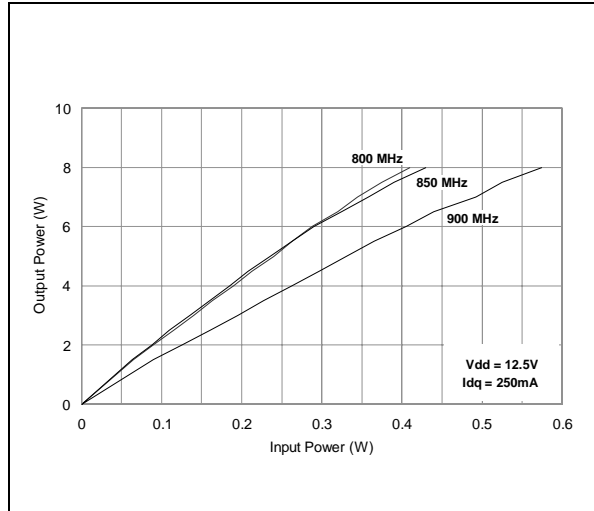

Drain Efficiency vs. Output Power

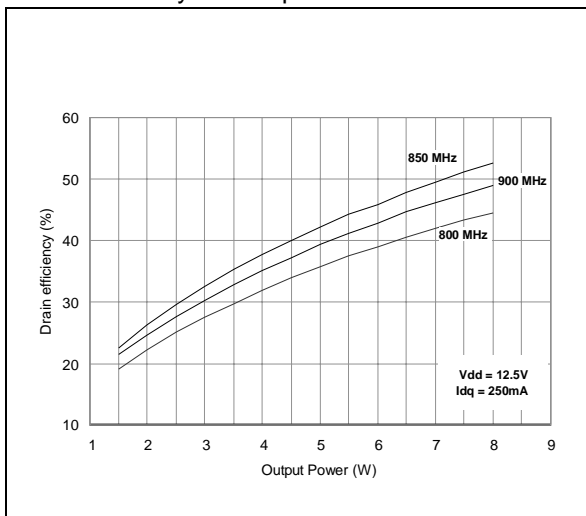

Input Return Loss vs. Output Power

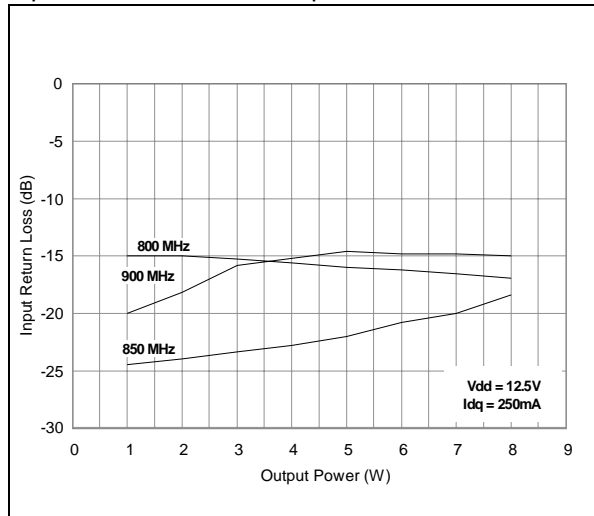

# PD55008 - PD55008S

## TYPICAL PERFORMANCE (PD55008S)

### Output Power vs. Input Power

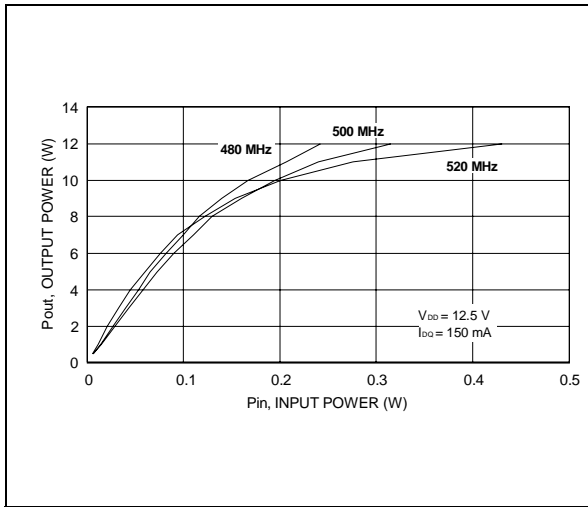

### Power Gain vs. Output Power

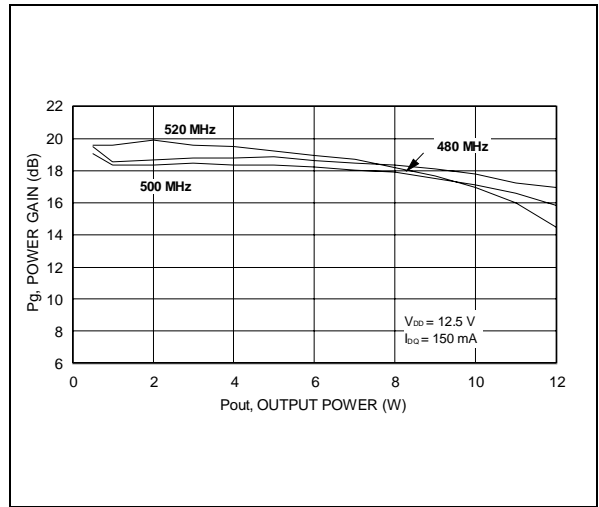

### Drain Efficiency vs. Output Power

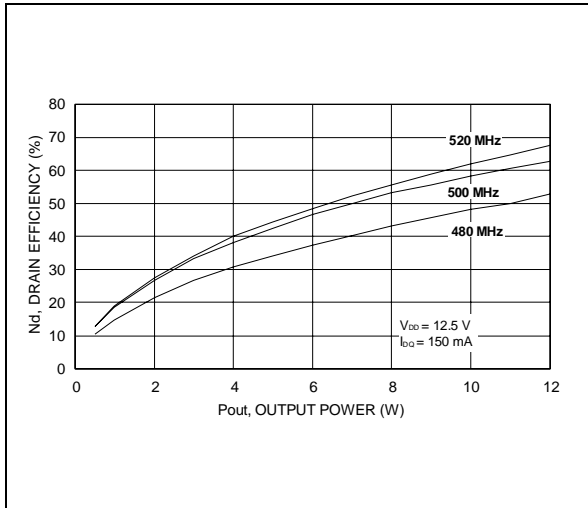

### Input Return Loss vs. Output Power

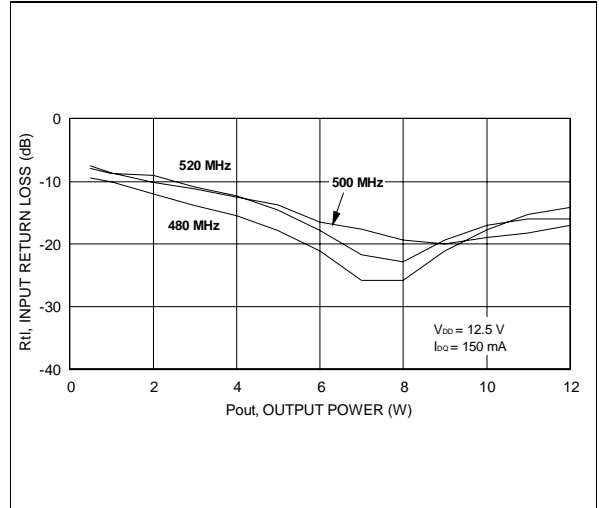

### Output Power vs. Bias Current

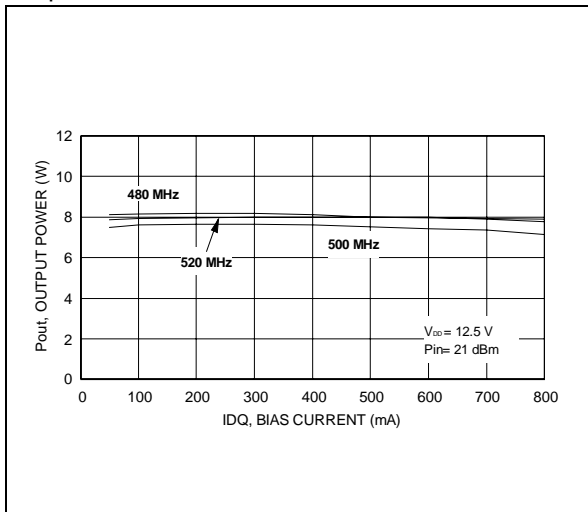

### Drain Efficiency vs. Bias Current

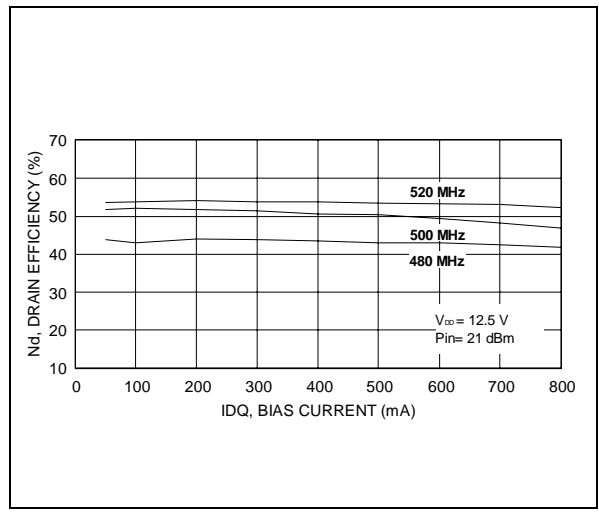

TYPICAL PERFORMANCE (PD55008S)

Output Power vs. Supply Voltage

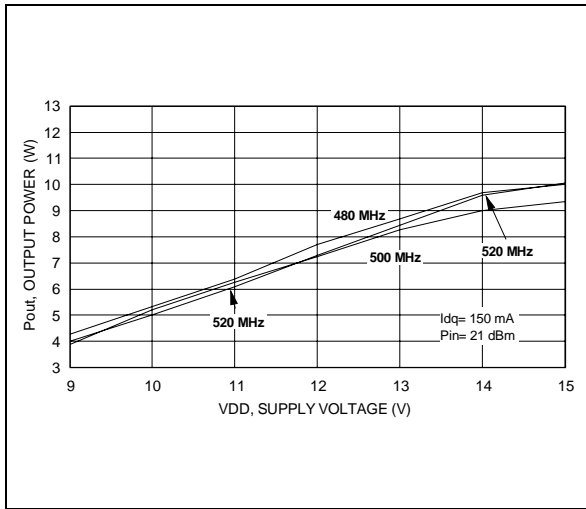

Drain Efficiency vs. Supply Voltage

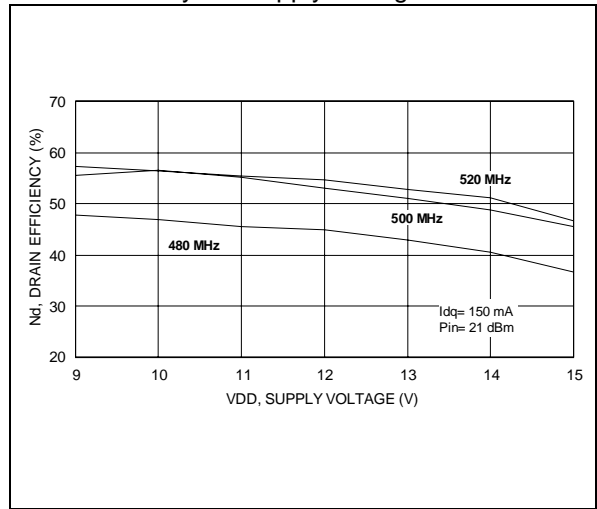

Output Power vs. Gate-Source Voltage

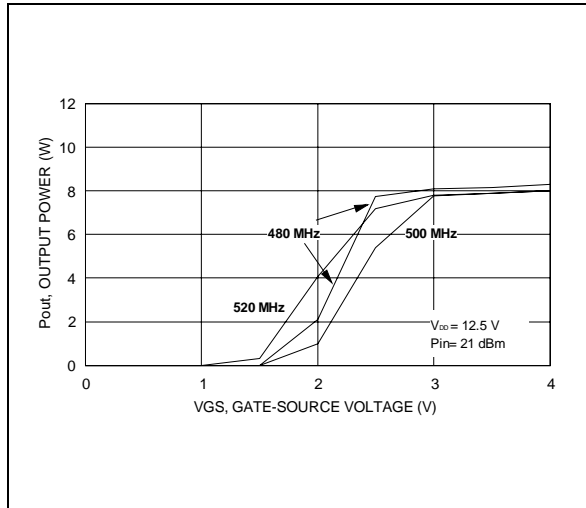

TEST CIRCUIT SCHEMATIC

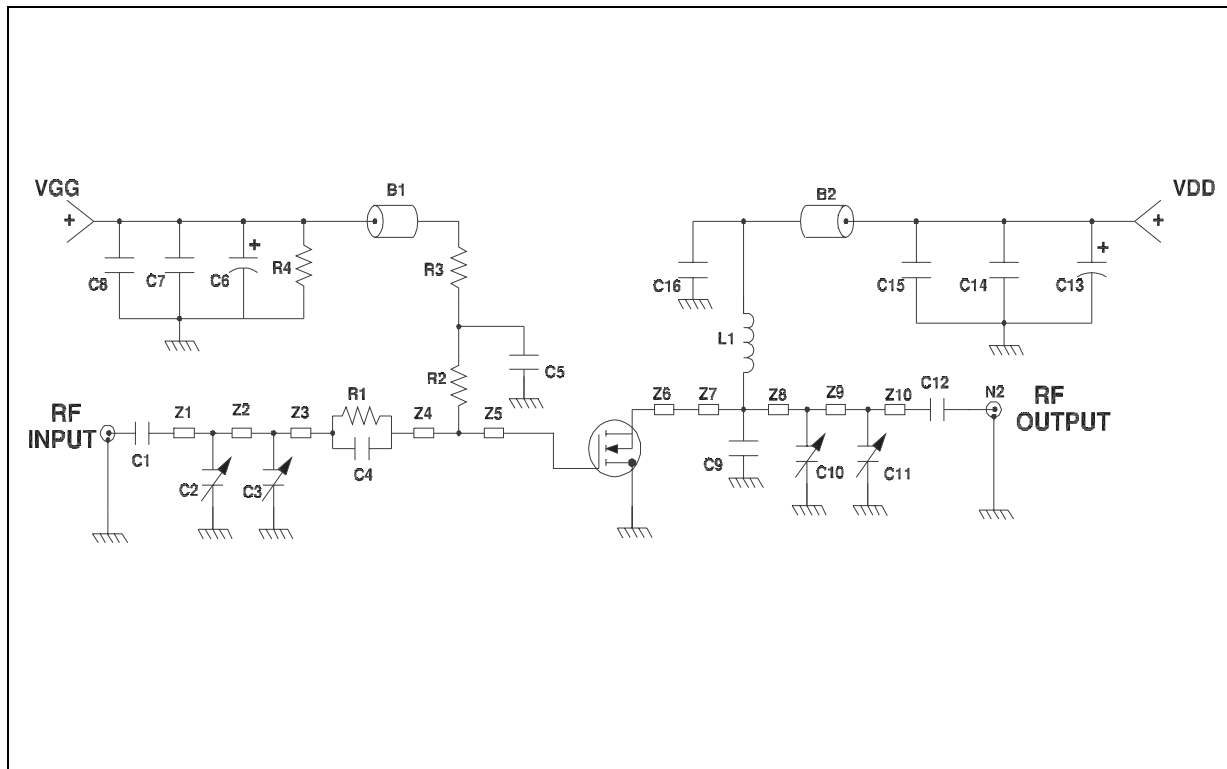

TEST CIRCUIT COMPONENT PART LIST

B1, B2	SHORT FERRITE BEAD, FAIR RITE PRODUCTS (2743021446)	R3	10 Ω, 0805 CHIP RESISTOR
C1, C12	240 pF, 100 mil CHIP CAPACITOR	R4	33 kΩ, 1/8 Ω RESISTOR
C2,C3,C10,C11	0 TO 20 pF, TRIMMER CAPACITOR	Z1	0.451" X 0.080" MICROSTRIP
C4	82 pF, 100 mil CHIP CAPACITOR	Z2	1.005" X 0.080" MICROSTRIP
C5,C16	120 pF, 100 mil CHIP CAPACITOR	Z3	0.020" X 0.080" MICROSTRIP
C6,C13	10 μF, 50 V ELECTROLYTIC CAPACITOR	Z4	0.155" X 0.080" MICROSTRIP
C7, C14	1.200 pF, 100 mil CHIP CAPACITOR	Z5,Z6	0.260" X 0.233" MICROSTRIP
C8,C15	0.1 F, 100 mil CHIP CAPACITOR	Z7	0.065" X 0.080" MICROSTRIP
C9	30 pF, 100 mil CHIP CAPACITOR	Z8	0.266" X 0.080" MICROSTRIP
L1	55.5 nH, TURN, COILCRAFT	Z9	1.113" X 0.080" MICROSTRIP
N1, N2	TYPE N FLANGE MOUNT	Z10	0.433" X 0.080" MICROSTRIP
R1	15 Ω, 0805 CHIP RESISTOR	BOARD	ROGER ULTRA LAM 2000 THK 0.030" ε <sub>r</sub> = 2.55 2oz ED Cu BOTH SIDES
R2	51 Ω, 1/2 W RESISTOR		



TEST CIRCUIT PHOTOMASTER

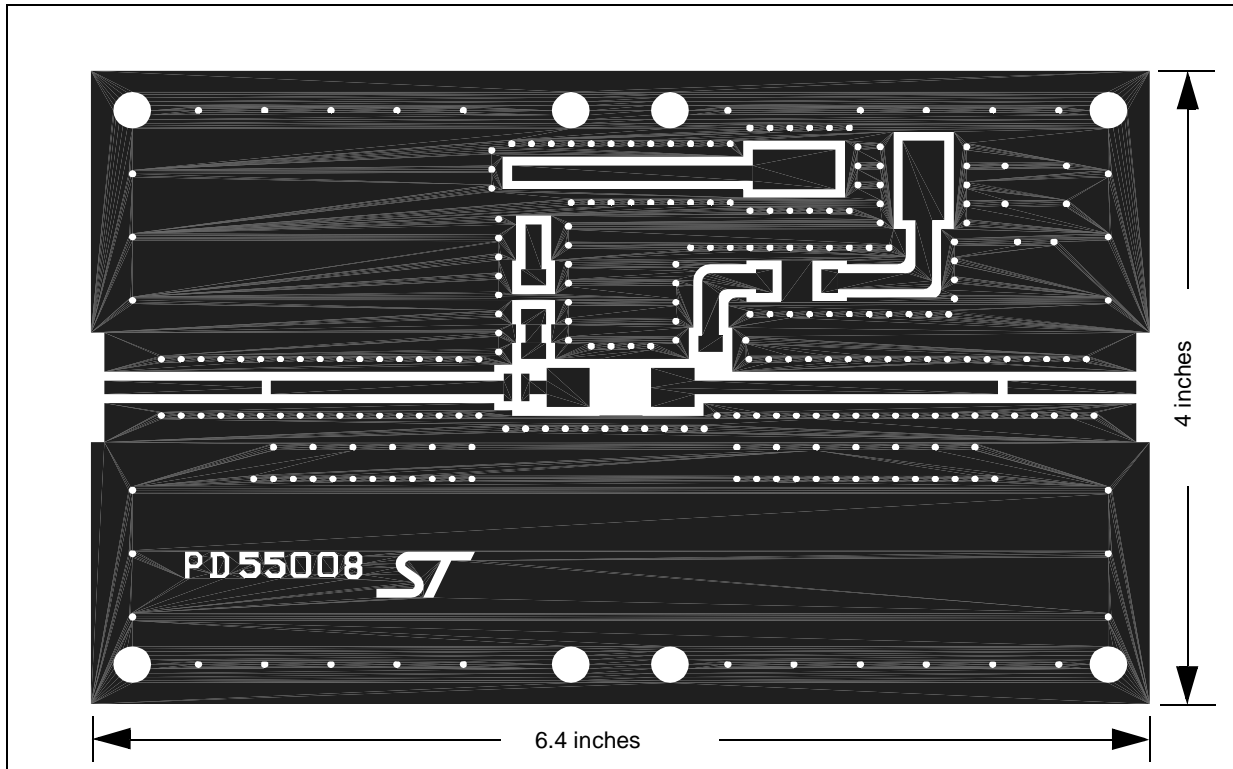

TEST CIRCUIT

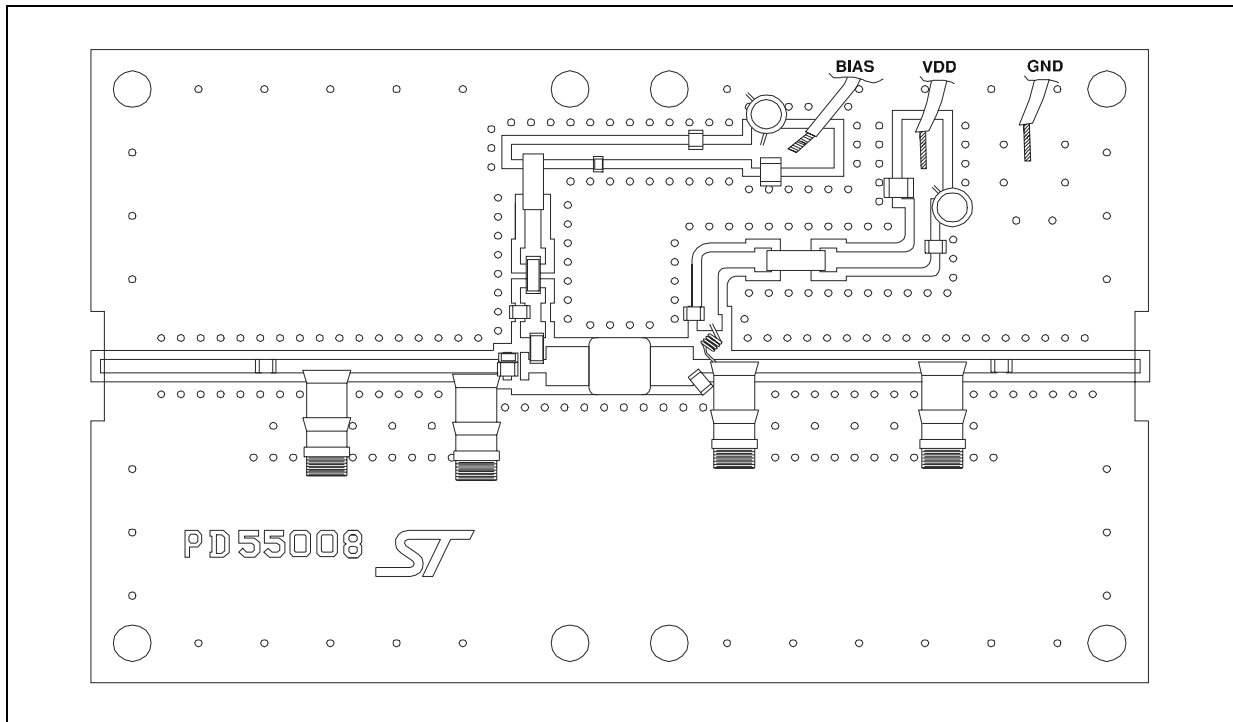

**PD55008 - PD55008S**

**COMMON SOURCE S-PARAMETER (PD55008)**

( $V_{DS} = 12.5V$   $I_{DS} = 150mA$ )

FREQ (MHz)	$ S_{11} $	$S_{11}\angle\Phi$	$ S_{21} $	$S_{21}\angle\Phi$	$ S_{12} $	$S_{12}\angle\Phi$	$ S_{22} $	$S_{22}\angle\Phi$
50	0.781	-141	16.89	93	0.035	4	0.685	-137
100	0.784	-157	8.14	77	0.035	-11	0.681	-151
150	0.803	-162	5.19	67	0.032	-18	0.704	-157
200	0.830	-165	3.69	58	0.030	-26	0.743	-159
250	0.852	-167	2.77	50	0.027	-34	0.773	-161
300	0.873	-169	2.16	44	0.025	-39	0.812	-164
350	0.892	-171	1.72	37	0.022	-43	0.844	-166
400	0.906	-172	1.40	33	0.020	-45	0.862	-168
450	0.919	-173	1.16	28	0.017	-47	0.888	-170
500	0.928	-175	0.97	24	0.015	-51	0.903	-171
550	0.936	-176	0.83	20	0.012	-52	0.913	-173
600	0.941	-177	0.71	17	0.010	-50	0.921	-174
650	0.946	-178	0.62	14	0.010	-52	0.926	-176
700	0.952	-179	0.55	11	0.008	-47	0.934	-177
750	0.954	180	0.48	9	0.006	-48	0.937	-178
800	0.957	179	0.44	7	0.006	-40	0.940	-180
850	0.959	178	0.39	4	0.004	-30	0.950	179
900	0.960	177	0.35	3	0.005	-1	0.952	178
950	0.963	176	0.32	1	0.004	17	0.957	177
1000	0.964	176	0.29	-1	0.004	28	0.958	176
1050	0.964	175	0.27	-3	0.004	43	0.953	175
1100	0.966	174	0.25	-4	0.005	42	0.955	174
1150	0.963	173	0.23	-6	0.005	59	0.954	173
1200	0.964	174	0.21	-8	0.007	58	0.952	172
1250	0.962	172	0.20	-9	0.008	57	0.956	171
1300	0.961	172	0.18	-11	0.008	57	0.953	171
1350	0.960	171	0.17	-11	0.010	68	0.950	170
1400	0.957	170	0.16	-12	0.010	61	0.957	169
1450	0.957	169	0.15	-12	0.011	67	0.942	168
1500	0.952	169	0.14	-13	0.011	76	0.944	167

**COMMON SOURCE S-PARAMETER (PD55008)**(V<sub>DS</sub> = 12.5V I<sub>DS</sub> = 800mA)

FREQ (MHz)	S <sub>11</sub>	∠S <sub>11</sub> °	S <sub>21</sub>	∠S <sub>21</sub> °	S <sub>12</sub>	∠S <sub>12</sub> °	S <sub>22</sub>	∠S <sub>22</sub> °
50	0.832	-156	20.68	90	0.022	3	0.740	-157
100	0.833	-167	9.98	80	0.022	-6	0.734	-165
150	0.839	-171	6.51	73	0.020	-11	0.741	-169
200	0.851	-172	4.78	67	0.020	-16	0.756	-169
250	0.851	-174	3.71	60	0.018	-20	0.767	-170
300	0.861	-174	3.00	55	0.017	-22	0.791	-172
350	0.872	-175	2.46	49	0.016	-23	0.813	-172
400	0.883	-176	2.06	44	0.014	-26	0.828	-173
450	0.894	-177	1.75	40	0.014	-26	0.849	-174
500	0.902	-178	1.50	35	0.012	-26	0.863	-175
550	0.910	-179	1.30	31	0.011	-27	0.874	-176
600	0.919	-179	1.14	28	0.010	-29	0.886	-177
650	0.923	180	1.01	25	0.009	-25	0.890	-178
700	0.929	179	0.90	22	0.008	-20	0.898	-179
750	0.934	178	0.81	19	0.007	-10	0.905	-180
800	0.937	177	0.73	16	0.006	-3	0.908	179
850	0.939	177	0.66	13	0.005	11	0.925	178
900	0.942	176	0.60	11	0.005	17	0.926	177
950	0.944	175	0.55	9	0.006	20	0.929	176
1000	0.949	175	0.51	6	0.006	25	0.935	176
1050	0.952	174	0.47	4	0.008	35	0.933	174
1100	0.954	173	0.43	2	0.007	38	0.935	173
1150	0.952	173	0.40	0	0.009	48	0.936	173
1200	0.954	172	0.37	-2	0.009	50	0.936	172
1250	0.951	171	0.34	-4	0.010	53	0.937	171
1300	0.950	171	0.32	-5	0.011	51	0.935	170
1350	0.951	170	0.30	-6	0.011	60	0.935	169
1400	0.948	170	0.28	-8	0.012	56	0.939	169
1450	0.947	169	0.27	-9	0.012	64	0.928	168
1500	0.944	168	0.25	-9	0.013	67	0.933	166

**PD55008 - PD55008S****COMMON SOURCE S-PARAMETER (PD55008)** $(V_{DS} = 12.5V \ I_{DS} = 1.5A)$ 

FREQ (MHz)	$ S_{11} $	$\angle S_{11}$	$ S_{21} $	$\angle S_{21}$	$ S_{12} $	$\angle S_{12}$	$ S_{22} $	$\angle S_{22}$
50	0.797	-161	20.72	90	0.020	2	0.743	-159
100	0.824	-168	10.01	80	0.019	-5	0.741	-167
150	0.849	-171	6.54	74	0.019	-9	0.746	-170
200	0.861	-173	4.83	67	0.018	-14	0.759	-171
250	0.870	-175	3.76	61	0.017	-19	0.770	-171
300	0.879	-175	3.04	56	0.016	-20	0.791	-173
350	0.887	-176	2.51	50	0.015	-21	0.811	-173
400	0.897	-177	2.11	45	0.013	-26	0.824	-174
450	0.905	-178	1.80	41	0.013	-23	0.847	-175
500	0.911	-178	1.54	37	0.011	-21	0.858	-175
550	0.917	-179	1.35	33	0.010	-23	0.871	-176
600	0.924	-180	1.17	29	0.009	-21	0.881	-177
650	0.927	179	1.04	26	0.009	-16	0.887	-178
700	0.933	179	0.93	23	0.007	-8	0.899	-179
750	0.937	178	0.83	20	0.007	-3	0.901	180
800	0.940	177	0.76	17	0.006	-2	0.906	179
850	0.941	177	0.68	14	0.007	0	0.918	178
900	0.944	176	0.63	12	0.006	21	0.920	177
950	0.946	175	0.58	10	0.008	17	0.927	176
1000	0.948	174	0.53	7	0.007	43	0.929	175
1050	0.952	174	0.49	5	0.008	44	0.929	175
1100	0.953	173	0.45	3	0.008	44	0.930	173
1150	0.952	172	0.42	1	0.009	47	0.931	173
1200	0.951	172	0.39	-1	0.010	51	0.928	172
1250	0.952	171	0.36	-3	0.010	51	0.932	171
1300	0.952	171	0.34	-5	0.011	52	0.931	170
1350	0.949	170	0.31	-7	0.011	53	0.931	169
1400	0.947	169	0.29	8	0.011	58	0.937	169
1450	0.945	169	0.28	-9	0.012	60	0.926	168
1500	0.942	168	0.26	-9	0.012	64	0.927	166

**COMMON SOURCE S-PARAMETER (PD55008S)**(V<sub>DS</sub> = 12.5V I<sub>DS</sub> = 150mA)

FREQ (MHz)	S <sub>11</sub>	∠S <sub>11</sub>	S <sub>21</sub>	∠S <sub>21</sub>	S <sub>12</sub>	∠S <sub>12</sub>	S <sub>22</sub>	∠S <sub>22</sub>
50	0.753	-146	15.56	92	0.036	4	0.666	-144
100	0.781	-159	7.52	78	0.036	-9	0.684	-157
150	0.812	-163	4.83	70	0.033	-17	0.717	-161
200	0.834	-166	3.46	62	0.032	-25	0.747	-162
250	0.856	-168	2.63	54	0.029	-31	0.784	-164
300	0.873	-169	2.07	48	0.028	-37	0.814	-165
350	0.887	-170	1.66	42	0.025	-42	0.836	-166
400	0.902	-172	1.37	37	0.023	-45	0.859	-168
450	0.915	-173	1.14	33	0.021	-48	0.873	-169
500	0.925	-174	0.96	29	0.019	-52	0.890	-171
550	0.935	-175	0.83	25	0.017	-56	0.906	-171
600	0.942	-176	0.71	22	0.015	-55	0.911	-173
650	0.946	-176	0.63	19	0.014	-56	0.922	-174
700	0.950	-177	0.55	16	0.013	-60	0.933	-175
750	0.956	-178	0.49	14	0.012	-58	0.936	-176
800	0.959	-179	0.44	12	0.010	-67	0.942	-177
850	0.964	-180	0.40	9	0.008	-66	0.942	-178
900	0.961	180	0.36	7	0.008	-65	0.947	-179
950	0.965	179	0.33	5	0.005	-62	0.954	-179
1000	0.967	178	0.30	3	0.006	-67	0.957	180
1050	0.970	178	0.27	2	0.004	-66	0.960	179
1100	0.970	177	0.25	0	0.004	-43	0.958	178
1150	0.970	177	0.23	-2	0.003	-42	0.963	178
1200	0.971	176	0.22	-3	0.002	-58	0.961	177
1250	0.973	175	0.20	-5	0.001	-13	0.960	177
1300	0.969	175	0.19	-6	0.001	31	0.956	176
1350	0.971	174	0.18	-7	0.002	60	0.959	175
1400	0.969	174	0.16	-7	0.001	67	0.957	175
1450	0.969	173	0.15	-8	0.003	79	0.965	174
1500	0.968	173	0.14	-9	0.004	125	0.965	174

**PD55008 - PD55008S****COMMON SOURCE S-PARAMETER (PD55008S)** $(V_{DS} = 12.5V \ I_{DS} = 800mA)$ 

FREQ (MHz)	$ S_{11} $	$S_{11}\angle\Phi$	$ S_{21} $	$S_{21}\angle\Phi$	$ S_{12} $	$S_{12}\angle\Phi$	$ S_{22} $	$S_{22}\angle\Phi$
50	0.862	-157	18.51	90	0.021	7	0.765	-161
100	0.861	-168	8.97	81	0.021	-4	0.767	-170
150	0.869	-171	5.88	76	0.020	-10	0.778	-172
200	0.872	-173	4.33	70	0.019	-14	0.782	-172
250	0.879	-174	3.40	65	0.019	-18	0.801	-173
300	0.888	-175	2.77	60	0.018	-20	0.810	-173
350	0.894	-175	2.30	55	0.017	-26	0.823	-173
400	0.905	-176	1.96	50	0.016	-31	0.836	-173
450	0.910	-177	1.67	46	0.015	-33	0.846	-174
500	0.916	-177	1.44	42	0.014	-31	0.862	-175
550	0.926	-178	1.27	38	0.013	-32	0.873	-175
600	0.930	-178	1.11	35	0.012	-37	0.880	-176
650	0.934	-179	0.96	32	0.011	-39	0.892	-176
700	0.938	-179	0.89	29	0.010	-38	0.901	-177
750	0.944	180	0.80	26	0.009	-38	0.907	-178
800	0.947	179	0.73	24	0.008	-38	0.913	-178
850	0.951	179	0.66	21	0.007	-36	0.914	-179
900	0.952	178	0.60	18	0.005	-44	0.920	180
950	0.953	178	0.55	16	0.005	-36	0.929	179
1000	0.955	177	0.51	14	0.005	-22	0.932	179
1050	0.957	176	0.48	11	0.004	-19	0.937	178
1100	0.960	176	0.44	9	0.003	-3	0.937	178
1150	0.961	176	0.41	7	0.004	2	0.943	177
1200	0.962	175	0.38	5	0.004	-4	0.940	177
1250	0.964	175	0.35	4	0.002	1	0.939	176
1300	0.961	174	0.33	2	0.003	31	0.937	176
1350	0.961	174	0.31	1	0.004	47	0.940	175
1400	0.959	173	0.29	1	0.003	56	0.939	174
1450	0.961	173	0.27	-1	0.004	59	0.945	173
1500	0.962	172	0.26	-2	0.004	87	0.946	173

**COMMON SOURCE S-PARAMETER (PD55008S)**

( $V_{DS} = 12.5V$   $I_{DS} = 1.5A$ )

FREQ (MHz)	$ S_{11} $	$S_{11}\angle\Phi$	$ S_{21} $	$S_{21}\angle\Phi$	$ S_{12} $	$S_{12}\angle\Phi$	$ S_{22} $	$S_{22}\angle\Phi$
50	0.821	-162	18.74	90	0.002	2	0.771	-163
100	0.849	-169	9.09	82	0.019	-5	0.776	-171
150	0.875	-171	5.97	77	0.018	-10	0.785	-173
200	0.885	-173	4.41	71	0.017	-12	0.789	-173
250	0.892	-175	3.47	66	0.017	17	0.807	-174
300	0.895	-175	2.84	61	0.016	-19	0.915	-174
350	0.901	-176	2.37	56	0.015	-22	0.924	-174
400	0.909	-177	2.02	52	0.014	-26	0.839	-174
450	0.914	-177	1.74	48	0.013	-28	0.844	-175
500	0.920	-178	1.50	43	0.013	-30	0.859	-176
550	0.928	-178	1.32	40	0.012	-28	0.871	-176
600	0.932	-179	1.17	37	0.011	-34	0.877	-176
650	0.935	-179	1.04	33	0.010	-31	0.887	-177
700	0.939	-180	0.93	30	0.009	-29	0.895	-177
750	0.946	179	0.84	28	0.008	-28	0.901	-178
800	0.946	179	0.77	25	0.008	-31	0.908	-179
850	0.953	178	0.70	22	0.007	-31	0.908	-179
900	0.952	178	0.64	19	0.006	-27	0.916	180
950	0.950	177	0.59	18	0.006	-33	0.924	179
1000	0.954	177	0.55	15	0.005	-21	0.928	178
1050	0.957	176	0.50	3	0.005	-20	0.930	178
1100	0.959	176	0.47	11	0.004	4	0.933	178
1150	0.959	175	0.44	8	0.004	13	0.937	177
1200	0.961	175	0.41	7	0.004	30	0.937	177
1250	0.962	174	0.38	5	0.003	29	0.935	176
1300	0.961	174	0.35	3	0.004	35	0.935	175
1350	0.961	174	0.33	2	0.004	55	0.935	174
1400	0.959	173	0.31	1	0.005	62	0.934	174
1450	0.960	172	0.29	0	0.005	65	0.942	173
1500	0.960	172	0.27	-1	0.005	81	0.942	173

**PowerSO-10RF Formed Lead (Gull Wing) MECHANICAL DATA**

DIM.	mm			Inch		
	MIN.	TYP.	MAX	MIN.	TYP.	MAX
A1	0	0.05	0.1	0.	0.0019	0.0038
A2	3.4	3.5	3.6	0.134	0.137	0.142
A3	1.2	1.3	1.4	0.046	0.05	0.054
A4	0.15	0.2	0.25	0.005	0.007	0.009
a		0.2			0.007	
b	5.4	5.53	5.65	0.212	0.217	0.221
c	0.23	0.27	0.32	0.008	0.01	0.012
D	9.4	9.5	9.6	0.370	0.374	0.377
D1	7.4	7.5	7.6	0.290	0.295	0.298
E	13.85	14.1	14.35	0.544	0.555	0.565
E1	9.3	9.4	9.5	0.365	0.37	0.375
E2	7.3	7.4	7.5	0.286	0.292	0.294
E3	5.9	6.1	6.3	0.231	0.24	0.247
F		0.5			0.019	
G		1.2			0.047	
L	0.8	1	1.1	0.030	0.039	0.042
R1			0.25			0.01
R2		0.8			0.031	
T	2 deg	5 deg	8 deg	2 deg	5 deg	8 deg
T1		6 deg			6 deg	
T2		10 deg			10 deg	

Note (1): Resin protrusions not included (max value: 0.15 mm per side)

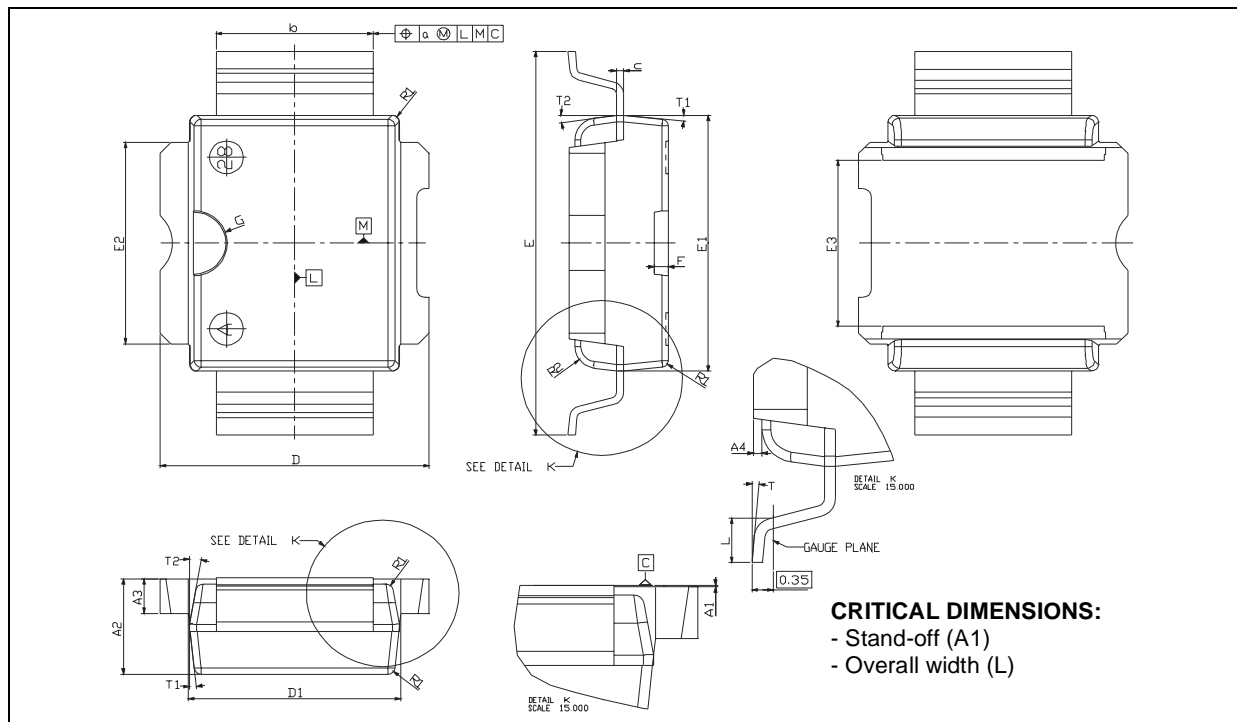



**PowerSO-10RF Straight Lead MECHANICAL DATA**

DIM.	mm			Inch		
	MIN.	TYP.	MAX	MIN.	TYP.	MAX
A1	1.62	1.67	1.72	0.064	0.065	0.068
A2	3.4	3.5	3.6	0.134	0.137	0.142
A3	1.2	1.3	1.4	0.046	0.05	0.054
A4	0.15	0.2	0.25	0.005	0.007	0.009
a		0.2			0.007	
b	5.4	5.53	5.65	0.212	0.217	0.221
c	0.23	0.27	0.32	0.008	0.01	0.012
D	9.4	9.5	9.6	0.370	0.374	0.377
D1	7.4	7.5	7.6	0.290	0.295	0.298
E	15.15	15.4	15.65	0.595	0.606	0.615
E1	9.3	9.4	9.5	0.365	0.37	0.375
E2	7.3	7.4	7.5	0.286	0.292	0.294
E3	5.9	6.1	6.3	0.231	0.24	0.247
F		0.5			0.019	
G		1.2			0.047	
R1			0.25			0.01
R2		0.8			0.031	
T1		6 deg			6 deg	
T2		10 deg			10 deg	

Note (1): Resin protrusions not included (max value: 0.15 mm per side)

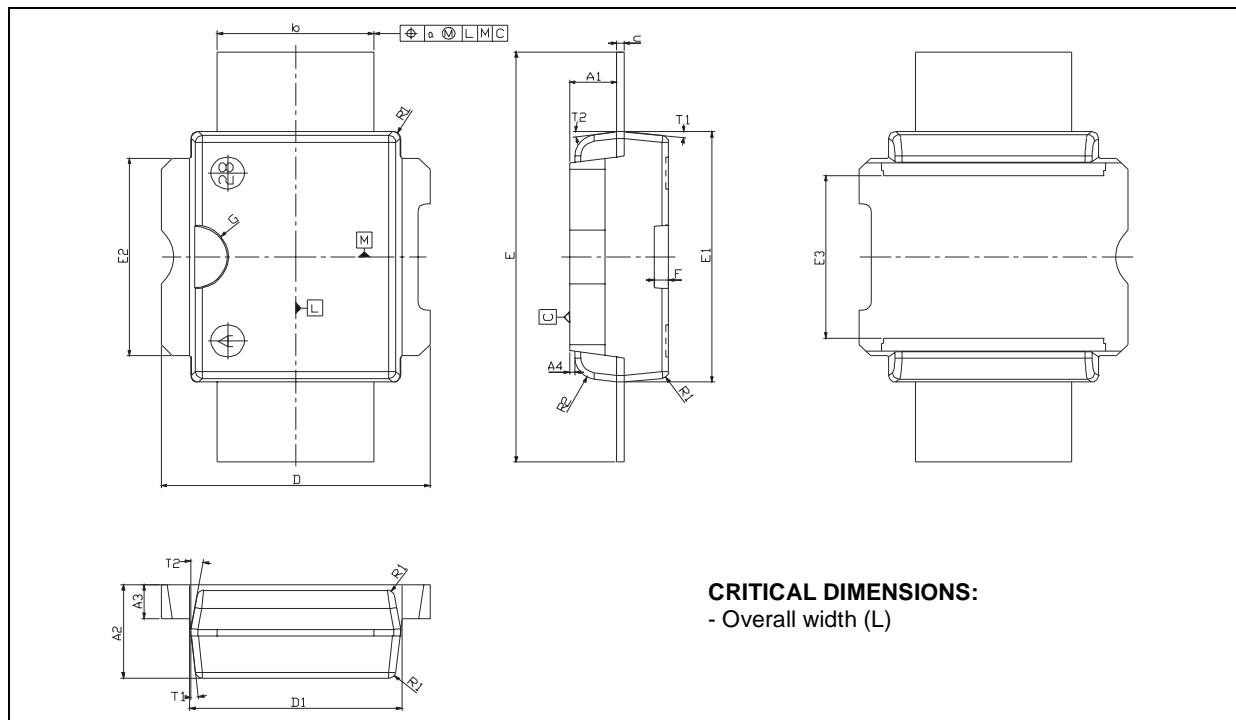

Information furnished is believed to be accurate and reliable. However, STMicroelectronics assumes no responsibility for the consequences of use of such information nor for any infringement of patents or other rights of third parties which may result from its use. No license is granted by implication or otherwise under any patent or patent rights of STMicroelectronics. Specifications mentioned in this publication are subject to change without notice. This publication supersedes and replaces all information previously supplied. STMicroelectronics products are not authorized for use as critical components in life support devices or systems without express written approval of STMicroelectronics.

The ST logo is registered trademark of STMicroelectronics  
© 2003 STMicroelectronics - All Rights Reserved

All other names are the property of their respective owners.

STMicroelectronics GROUP OF COMPANIES  
Australia - Brazil - Canada - China - Finland - France - Germany - Hong Kong - India - Israel - Italy - Japan -  
Malaysia - Malta - Morocco - Singapore - Spain - Sweden - Switzerland - United Kingdom - U.S.A.  
<http://www.st.com>