

## SWITCHING REGULATOR CONTROL IC FOR FLYBACK WITH CURRENT SENSE AMPLIFIER

### ■GENERAL DESCRIPTION

The **NJM2382** is a low voltage operation switching regulator control IC.

It features totem pole output directly driving external bipolar transistor and operates at high switching frequency which improves transient response. In addition, low power standby function is incorporated.

It is suitable for LCD back light, and other portable applications.

### ■PACKAGE OUTLINE

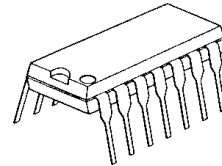

**NJM2382D**

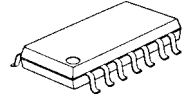

**NJM2382M**



**NJM2382V**

### ■FEATURES

- PWM switching control
- Operating Voltage (3.6 to 32V)
- Wide Oscillator Range (5 to 350 kHz)
- ON/OFF Circuit (High Active)
- Current Sensing Amplifier
- Soft-Start Function
- UVLO(Under Voltage Lockouts)
- Bipolar Technology
- Package Outline DIP14, DMP14, SSOP10

### ■PIN CONFIGURATION

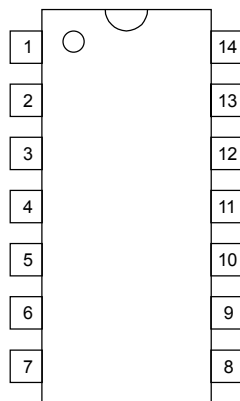

**NJM2382D**

**NJM2382M**

#### PIN FUNCTION

1.NC	8.NC
2.IN <sup>-</sup> 1	9. V <sup>+</sup>
3.IN <sup>-</sup> 2	10.CS
4.F.B	11.CT
5.GND	12.REF
6.OUT	13.ON/OFF
7.NC	14.NC

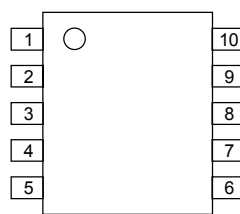

**NJM2382V**

#### PIN FUNCTION

1.IN <sup>-</sup> 1	6. V <sup>+</sup>
2.IN <sup>-</sup> 2	7.CS
3.F.B	8.CT
4.GND	9.REF
5.OUT	10.ON/OFF

# NJM2382

## ■BLOCK DIAGRAM

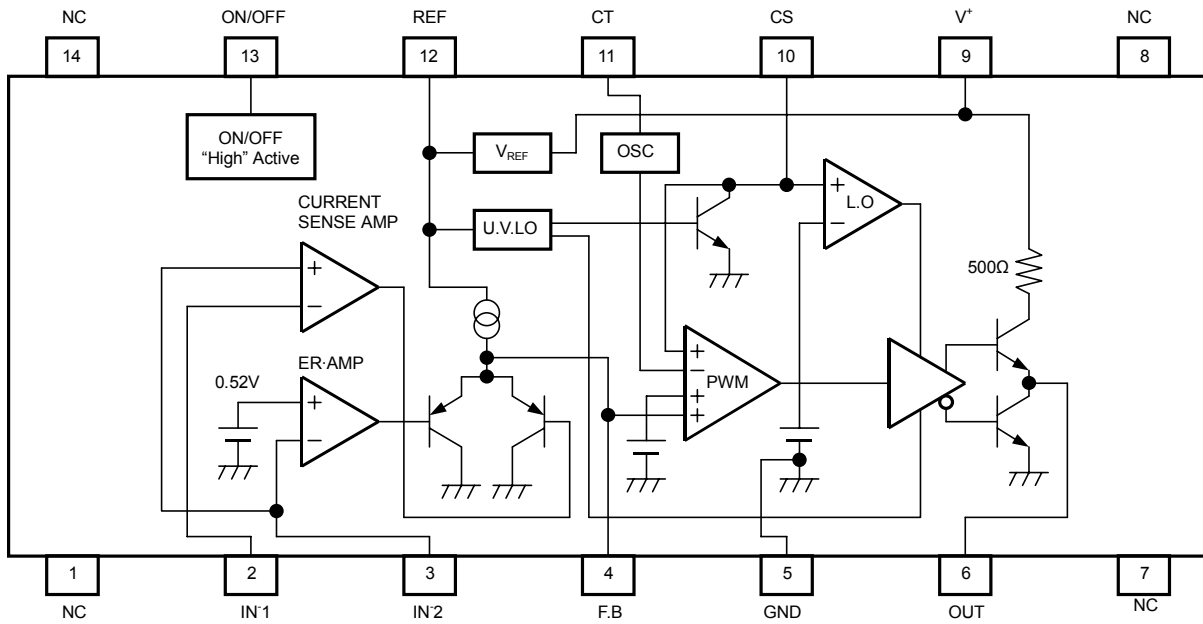

(Package: DIP14, DMP14)

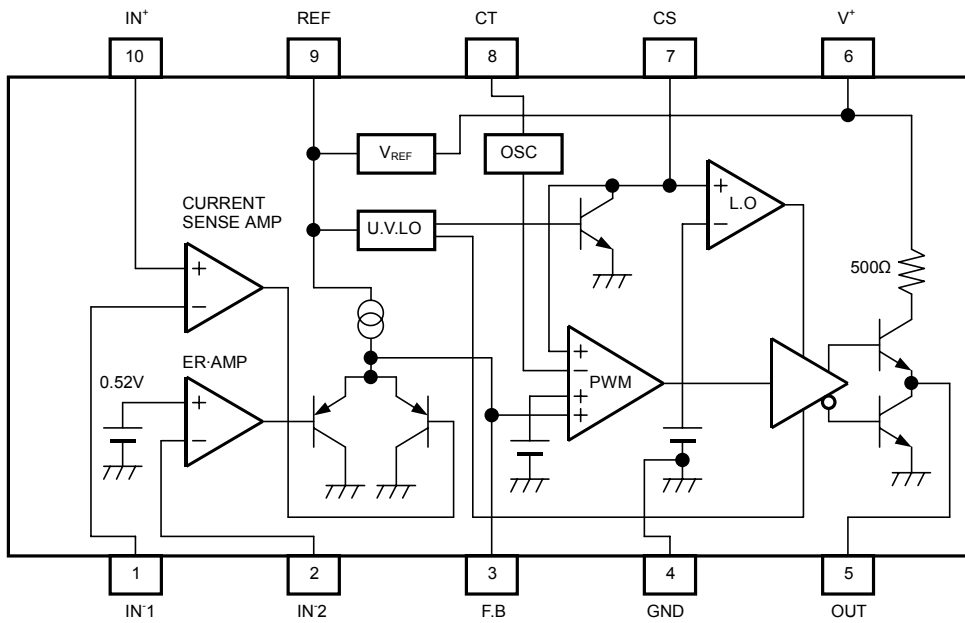

(Package: SSOP10)

## ■ABSOLUTE MAXIMUM RATINGS (Ta=25°C)

PARAMETER	SYMBOL	MAXIMUM RATINGS	UNIT
Input Voltage	V <sup>+</sup>	36	V
Reference Output Current	I <sub>OR</sub>	10	mA
Output Current	I <sub>O</sub>	±50	mA
Differential Input Voltage	V <sub>ID</sub>	2.5	V
Common Mode Input Voltage	V <sub>IC</sub>	-0.3 ~ 2.5	V
ON/OFF Control Voltage	V <sub>ON/OFF</sub>	-0.3 ~ 36 (note)	V
Power Dissipation	P <sub>D</sub>	(DIP 14) 700 (DMP 14) 300 (SSOP 14) 250	mW
Operating Temperature Range	T <sub>OPR</sub>	-40 ~ +85	°C
Storage Temperature Range	T <sub>STG</sub>	-50 ~ +125	°C

(note) When the supply voltage is less than 36V, the absolute maximum input voltage is equal to the supply voltage.

## ■ELECTRICAL CHARACTERISTICS (V<sup>+</sup>=6V, R<sub>T</sub>=33kΩ, C<sub>T</sub>=1000pF, V<sub>ON/OFF</sub>=3V, Ta=25°C)

### REFERENCE VOLTAGE BLOCK

PARAMETER	SYMBOL	TEST CONDITION	MIN.	TYP.	MAX.	UNIT
Output Voltage	V <sub>REF</sub>	I <sub>OR</sub> =1mA	2.45	2.50	2.55	V
Line Regulation	L <sub>LINE</sub>	V <sup>+</sup> =3.6 ~ 32V, I <sub>OR</sub> =1mA	–	6.8	20.7	mV
Load Regulation	L <sub>LOAD</sub>	I <sub>OR</sub> =0.1 ~ 5.0mA	–	5	30	mV

### OSCILLATOR BLOCK

PARAMETER	SYMBOL	TEST CONDITION	MIN.	TYP.	MAX.	UNIT
Oscillation Frequency	f <sub>OSC</sub>	R <sub>T</sub> =33kΩ, C <sub>T</sub> =1000pF	85	105	125	kHz
Oscillate Fluctuations1 (Line Fluctuations)	f <sub>dV</sub>	V <sup>+</sup> =3.6 ~ 32V	–	1	–	%
Oscillate Fluctuations2 (Temp Fluctuations)	f <sub>dT</sub>	Ta=-40 ~ 85°C	–	5	–	%

### CURRENT SENSE AMPLIFIER BLOCK

PARAMETER	SYMBOL	TEST CONDITION	MIN.	TYP.	MAX.	UNIT
Input Offset Voltage1	V <sub>IO1</sub>		–	2	7	mV
Input Offset Current1	I <sub>IO1</sub>		–	5	–	nA
Input Bias Current1	I <sub>B1</sub>		–	20	100	nA
Open Loop Gain1	A <sub>V1</sub>		–	90	–	dB
Gain Bandwidth Product1	G <sub>B1</sub>		–	0.6	–	MHz
Input Common Mode Voltage Ratio1	V <sub>ICM1</sub>		–	0 ~ V <sub>REF</sub> -0.8	–	V
Maximum Output Voltage1 (F.B Pin)	V <sub>OM-1</sub>	R <sub>NF</sub> =100kΩ	–	–	1	V
Maximum Source Current1 (F.B Pin)	I <sub>OM+1</sub>	V <sub>OM</sub> =0.5V	40	85	200	μA

# NJM2382

■ ELECTRICAL CHARACTERISTICS ( $V^+=6V, R_T=33k\Omega, C_T=1000pF, V_{ON/OFF}=3V, T_a=25^\circ C$ )

## ERROR AMPLIFIER BLOCK

PARAMETER	SYMBOL	TEST CONDITION	MIN.	TYP.	MAX.	UNIT
Reference Voltage2	$V_{B2}$		0.51	0.52	0.53	V
Input Bias Voltage2	$I_{B2}$		–	5	100	nA
Open Loop Gain2	$A_{V2}$		–	90	–	dB
Gain Bandwidth Product2	$G_{B2}$		–	0.6	–	MHz
Maximum Output Voltage2 (F.B Pin)	$V_{OM-2}$	$R_{NF}=100k\Omega$	–	–	1	V
Maximum Source Current2 (F.B Pin)	$I_{OM+2}$	$V_{OM}=0.5V$	40	85	200	$\mu A$

## PWM COMPARATE BLOCK

PARAMETER	SYMBOL	TEST CONDITION	MIN.	TYP.	MAX.	UNIT
Input Bias Voltage (F.B Pin)	$V_{TH0}$	duty·cycle=0%	–	1.65	1.75	V
Input Threshold Voltage (F.B Pin)	$V_{TH50}$	duty·cycle=50%	–	1.88	–	V
Maximum Duty Cycle	$\alpha M$	Current Sense Amp.=HIGH Error Amp.=HIGH, CS Pin=1.2V	55	64	85	%

## SOFT START CIRCUIT BLOCK

PARAMETER	SYMBOL	TEST CONDITION	MIN.	TYP.	MAX.	UNIT
Input Bias Current (CS Pin)	$I_{BCS}$	CS Pin=1.8V	–	250	650	nA
Input Threshold Voltage (CS Pin)	$V_{THCS0}$	duty·cycle=0%	–	0.25	0.35	V
Input Threshold Voltage (CS Pin)	$V_{THCS50}$	duty·cycle=50%	–	0.52	–	V

## UNDER VOLTAGE LOCKOUT BLOCK

PARAMETER	SYMBOL	TEST CONDITION	MIN.	TYP.	MAX.	UNIT
ON Threshold Voltage	$V_{THON}$		–	2.70	–	V
OFF Threshold Voltage	$V_{THOFF}$		–	2.52	–	V
Hysteresis Voltage	$V_{HYS}$		60	180	–	mV

## OUTPUT BLOCK

PARAMETER	SYMBOL	TEST CONDITION	MIN.	TYP.	MAX.	UNIT
H-Output Voltage (OUT Pin)	$V_{OH}$	$R_L=10k\Omega$	3.50	4.00	–	V
L-Output Voltage (OUT Pin)	$V_{OL}$	Output Sink Current=20mA	–	0.25	0.65	V
Output Source Current (OUT Pin)	$I_{SOURCE}$	OUT Pin=0V	8	11	–	mA

## ■ ELECTRICAL CHARACTERISTICS ( $V^+=6V, R_T=33k\Omega, C_T=1000pF, V_{ON/OFF}=3V, T_a=25^\circ C$ )

### ON/OFF BLOCK

PARAMETER	SYMBOL	TEST CONDITION	MIN.	TYP.	MAX.	UNIT
OFF Threshold Voltage (ON/OFF Pin)	$V_{OFF}$		-	-	0.3	V
ON Threshold Voltage (ON/OFF Pin)	$V_{ON}$		1.1	-	-	V
Input Bias Current (ON/OFF Pin)	$I_{ON/OFF}$	$V_{ON/OFF}=3V$	-	100	120	$\mu A$

### GENERAL CHARACTERISTICS

PARAMETER	SYMBOL	TEST CONDITION	MIN.	TYP.	MAX.	UNIT
Standby Current	$I_{CCSTBY}$	Standby Mode, $V_{ON/OFF}=0V$	-	12	20	$\mu A$
Latch Mode Threshold Voltage (CS Pin)	$V_{THLA}$		1.2	1.5	1.8	V
Quiescent Current	$I_{CCLA}$	Latch Mode	-	1.6	2.2	mA
Average Quiescent Current	$I_{CCAV}$	$RL = \infty$ , duty-cycle=50%	-	3.5	4.8	mA

### ■ TYPICAL APPLICATIONS

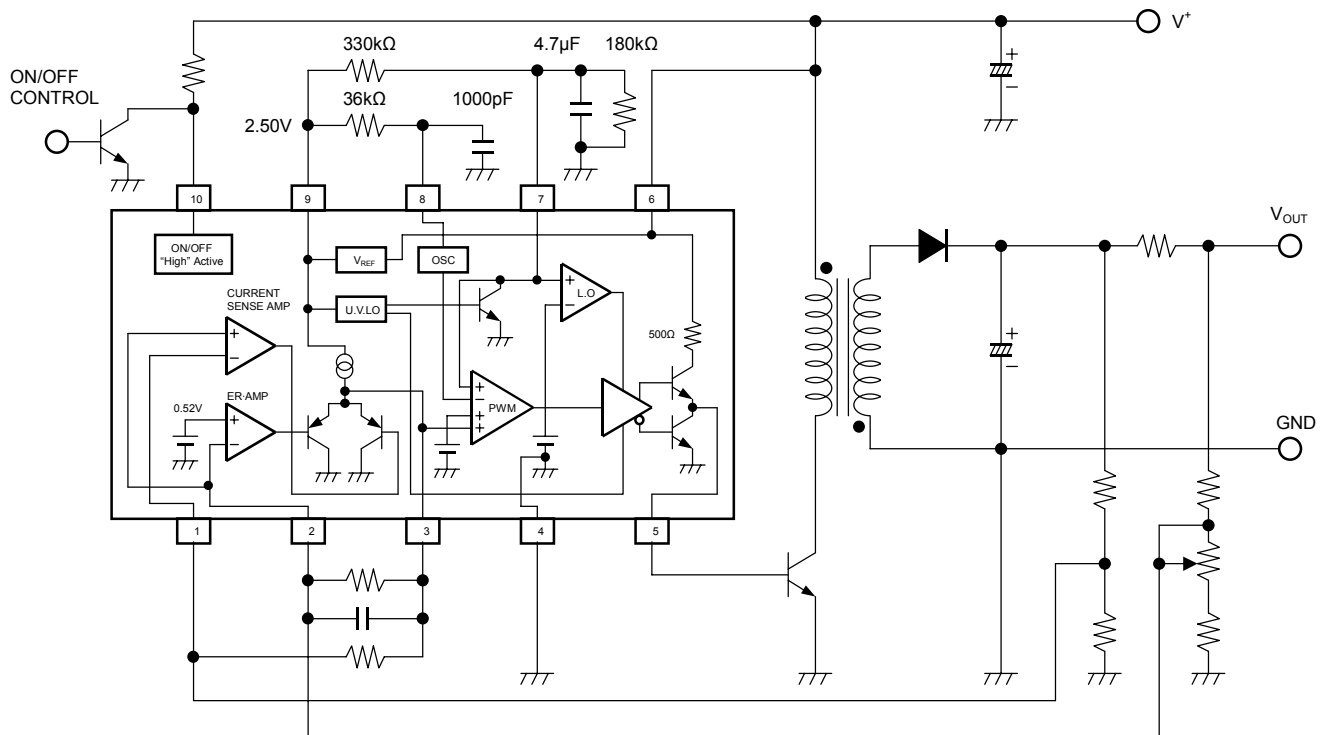

(Package:SSOP10)

## TYPICAL CHARACTERISTICS

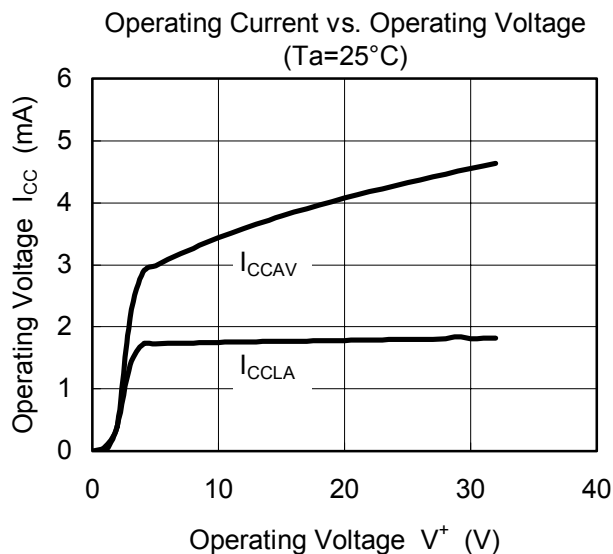
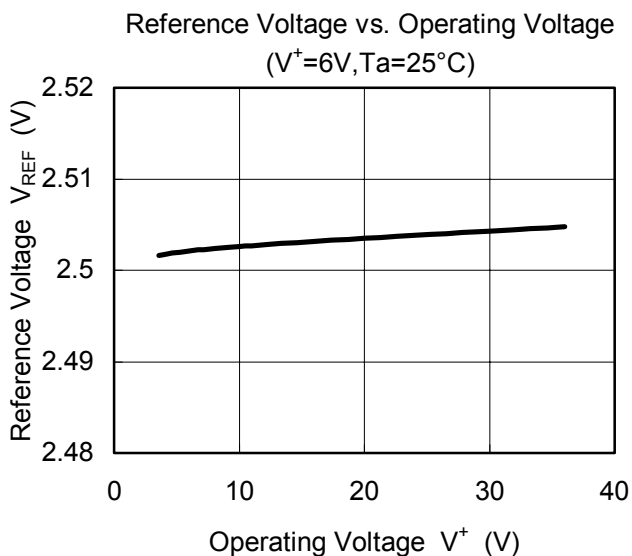
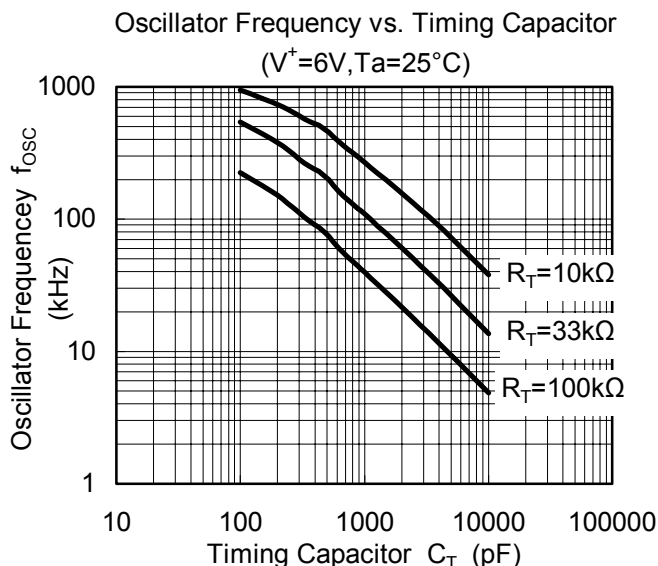
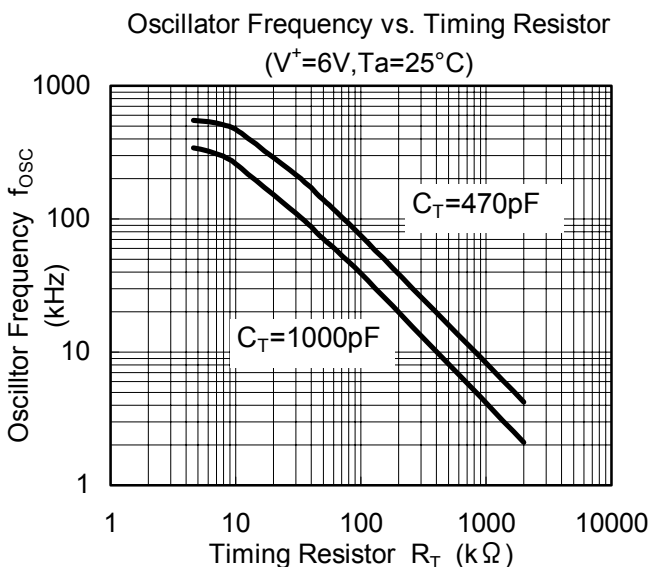
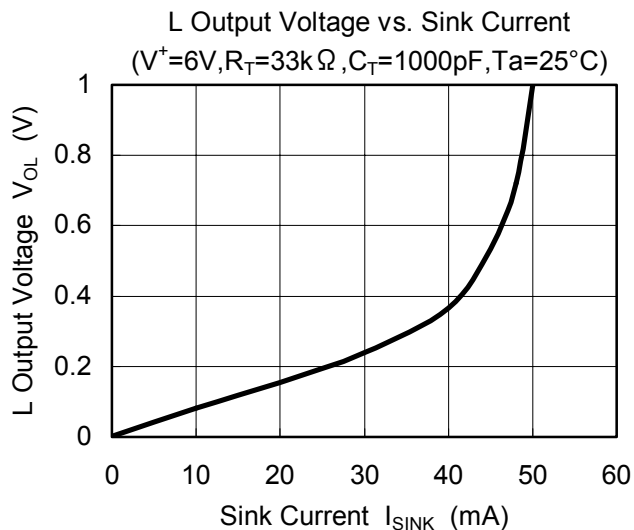
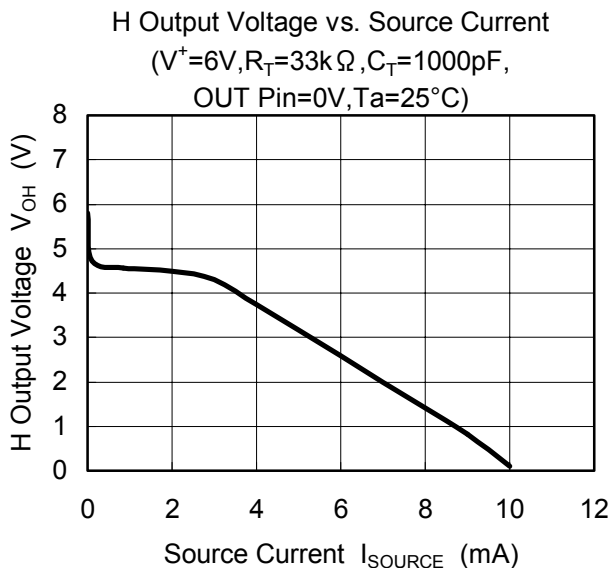

## ■ TYPICAL CHARACTERISTICS

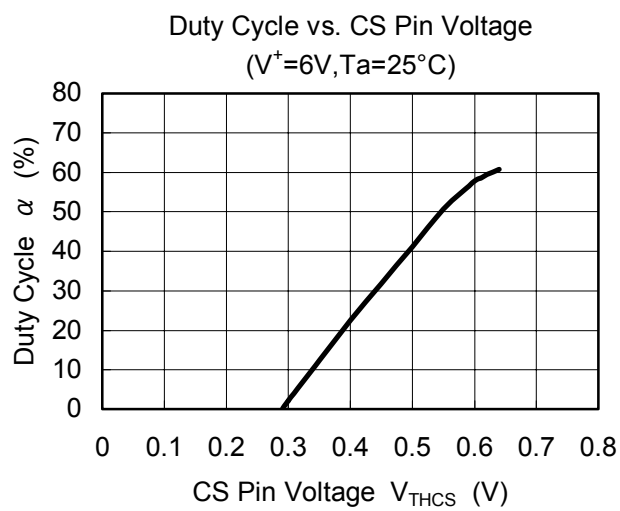
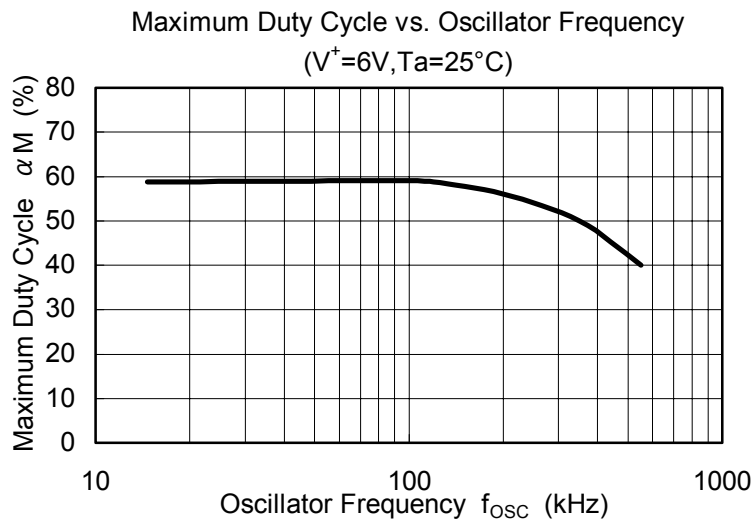

## TYPICAL CHARACTERISTICS

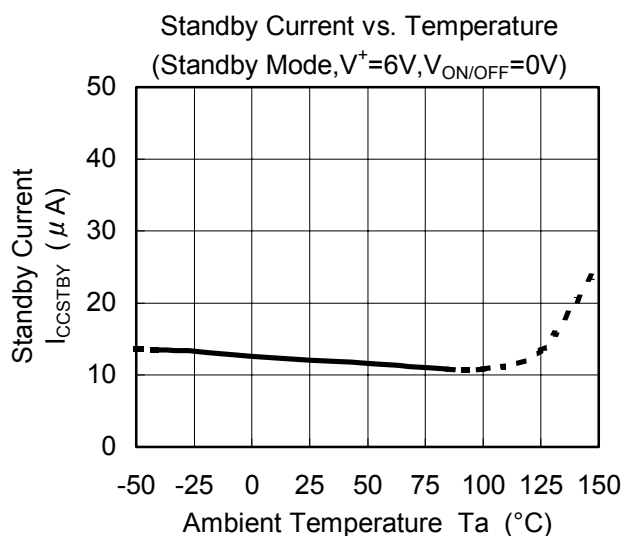
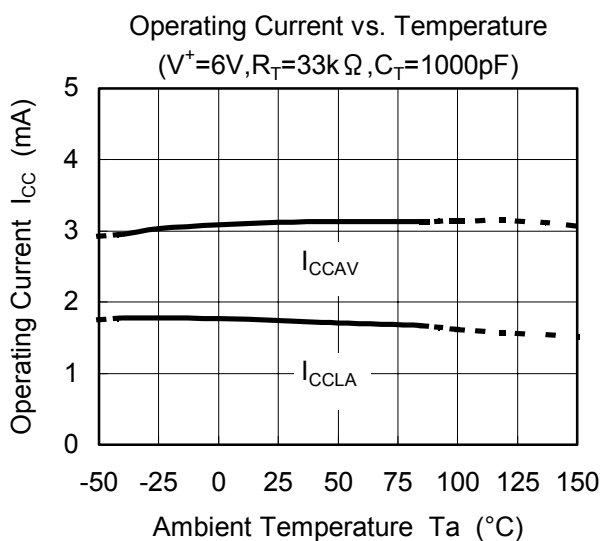
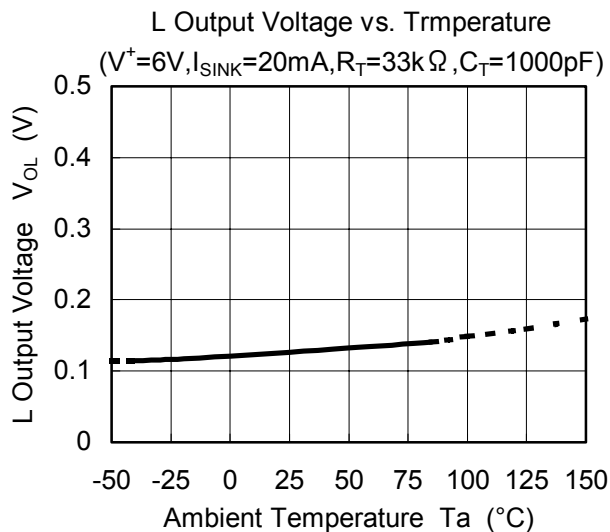
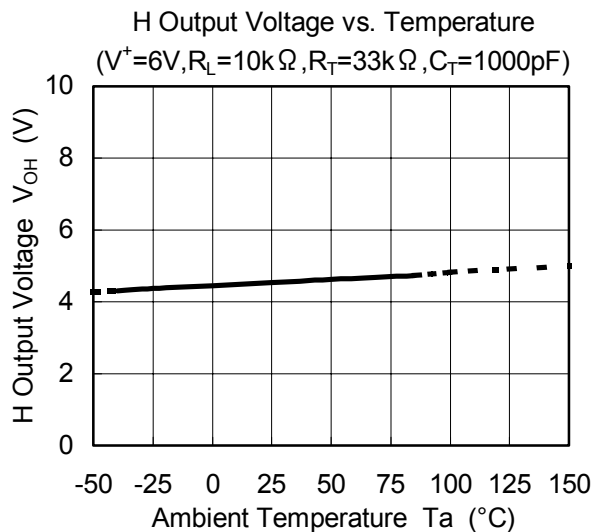
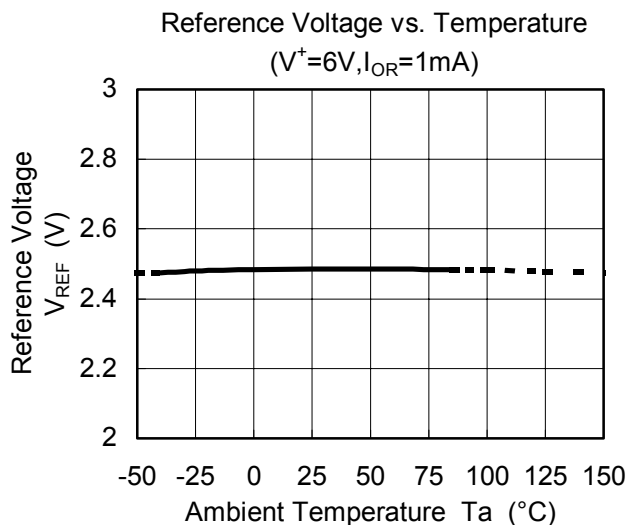
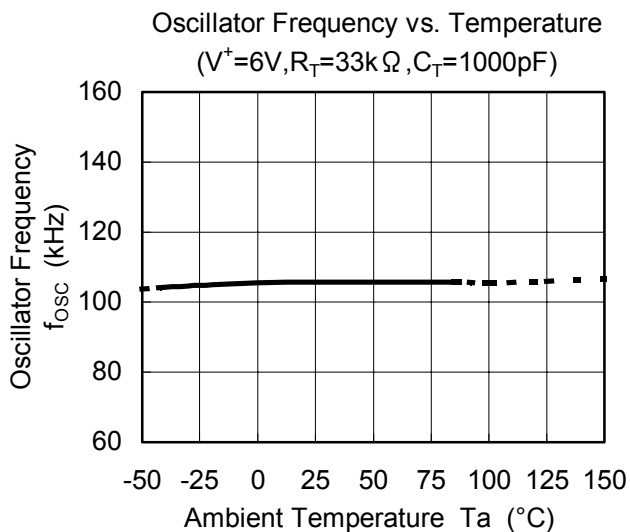



# MEMO

**[CAUTION]**

The specifications on this databook are only given for information, without any guarantee as regards either mistakes or omissions. The application circuits in this databook are described only to show representative usages of the product and not intended for the guarantee or permission of any right including the industrial rights.