

# 6MBI300U-120



## IGBT Module U-Series 1200V / 300A 6 in one-package

### ■ Features

- High speed switching
- Voltage drive
- Low inductance module structure

### ■ Applications

- Inverter for Motor drive
- AC and DC Servo drive amplifier
- Uninterruptible power supply
- Industrial machines, such as Welding machines

### ■ Maximum ratings and characteristics

#### ● Absolute maximum ratings (at Tc=25°C unless otherwise specified)

Item	Symbol	Conditions	Rating	Unit	
Collector-Emitter voltage	V <sub>CES</sub>		1200	V	
Gate-Emitter voltage	V <sub>GES</sub>		±20	V	
Collector current	I <sub>c</sub>	Continuous	T <sub>c</sub> =25°C	450	A
			T <sub>c</sub> =80°C	300	
	I <sub>cp</sub>	1ms	T <sub>c</sub> =25°C	900	
			T <sub>c</sub> =80°C	600	
	-I <sub>c</sub>			300	
-I <sub>c</sub> pulse			600		
Collector Power Dissipation	P <sub>c</sub>	1 device	1385	W	
Junction temperature	T <sub>j</sub>		+150	°C	
Storage temperature	T <sub>stg</sub>		-40 to +125		
Isolation voltage	between terminal and copper base *1	V <sub>iso</sub>	AC:1min.	2500	VAC
	between thermistor and others *2				
Screw Torque	Mounting *3	-		3.5	N·m
	Terminals *4			4.5	

\*1 : All terminals should be connected together when isolation test will be done.

\*2 : Two thermistor terminals should be connected together, each other terminals should be connected together and shorted to base plate when isolation test will be done.

\*3 : Recommendable value : 2.5 to 3.5 N·m(M5) \*4 : Recommendable value : 3.5 to 4.5 N·m(M6)

#### ● Electrical characteristics (at T<sub>j</sub>=25°C unless otherwise specified)

Item	Symbols	Conditions	Characteristics			Unit	
			Min.	Typ.	Max.		
Zero gate voltage collector current	ICES	V <sub>GE</sub> =0V, V <sub>CES</sub> =1200V	-	-	3.0	mA	
Gate-Emitter leakage current	IGES	V <sub>CE</sub> =0V, V <sub>GE</sub> =±20V	-	-	600	nA	
Gate-Emitter threshold voltage	V <sub>GE(th)</sub>	V <sub>CE</sub> =20V, I <sub>c</sub> =300mA	4.5	6.5	8.5	V	
Collector-Emitter saturation voltage	V <sub>CE(sat)</sub> (terminal)	V <sub>GE</sub> =15V, I <sub>c</sub> =300A	T <sub>j</sub> =25°C	-	2.05	2.40	V
			T <sub>j</sub> =125°C	-	2.30	-	
	V <sub>CE(sat)</sub> (chip)		T <sub>j</sub> =25°C	-	1.75	2.10	
			T <sub>j</sub> =125°C	-	2.00	-	
Input capacitance	C <sub>ies</sub>	V <sub>CE</sub> =10V, V <sub>GE</sub> =0V, f=1MHz	-	34	-	nF	
Turn-on time	t <sub>on</sub>	V <sub>CC</sub> =600V	-	0.36	1.20	μs	
	t <sub>r</sub>	I <sub>c</sub> =300A	-	0.21	0.60		
	t <sub>r(i)</sub>	V <sub>GE</sub> =±15V	-	0.03	-		
Turn-off time	t <sub>off</sub>	R <sub>G</sub> =2 Ω	-	0.37	1.00	μs	
	t <sub>f</sub>		-	0.07	0.30		
Forward on voltage	V <sub>F</sub> (terminal)	V <sub>GE</sub> =0V I <sub>F</sub> =300A	T <sub>j</sub> =25°C	-	1.90	2.20	V
			T <sub>j</sub> =125°C	-	2.00	-	
	V <sub>F</sub> (chip)		T <sub>j</sub> =25°C	-	1.60	1.90	
			T <sub>j</sub> =125°C	-	1.70	-	
Reverse recovery time	t <sub>rr</sub>	I <sub>F</sub> =300A	-	-	0.35	μs	
Lead resistance, terminal-chip*4	R lead		-	1.0	-	mΩ	
Thermistor	Resistance	R	T=25°C	-	5000	-	Ω
			T=100°C	465	495	520	
	B value	B	T=25/50°C	3305	3375	3450	K

\*4:Biggest internal terminal resistance among arm.

#### ● Thermal resistance characteristics

Items	Symbols	Conditions	Characteristics			Unit
			Min.	Typ.	Max.	
Thermal resistance	R <sub>th(j-c)</sub>	IGBT	-	-	0.09	°C/W
	R <sub>th(j-c)</sub>	FWD	-	-	0.15	°C/W
Contact Thermal resistance	R <sub>th(c-f)</sub> *5	With thermal compound	-	0.0167	-	°C/W

\*5 : This is the value which is defined mounting on the additional cooling fin with thermal compound.

Characteristics (Representative)

Collector current vs. Collector-Emitter voltage (typ.)  
T<sub>j</sub>= 25°C / chip

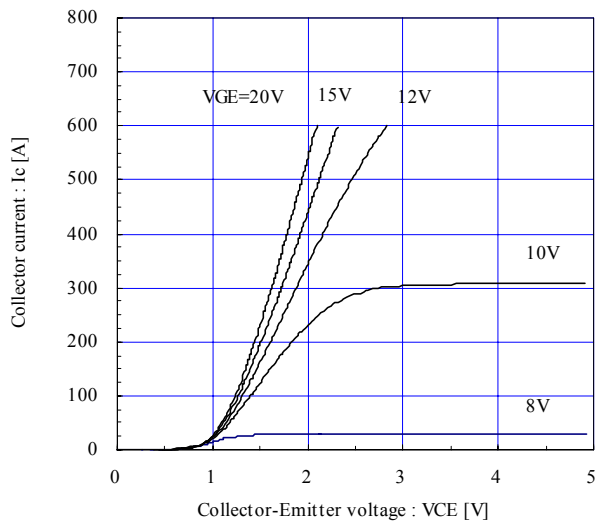

Collector current vs. Collector-Emitter voltage (typ.)  
T<sub>j</sub>= 125°C / chip

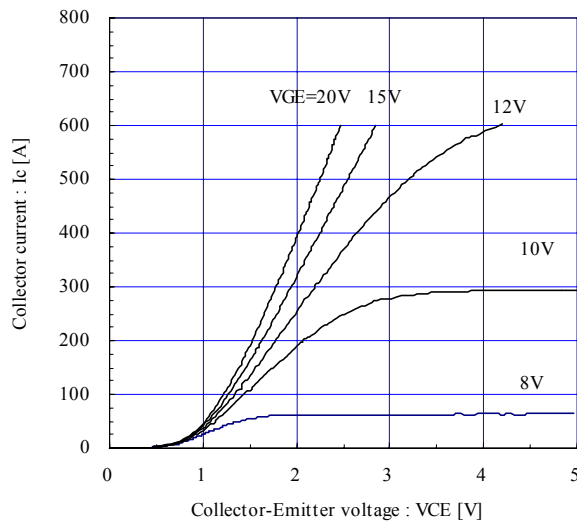

Collector current vs. Collector-Emitter voltage (typ.)  
VGE=15V / chip

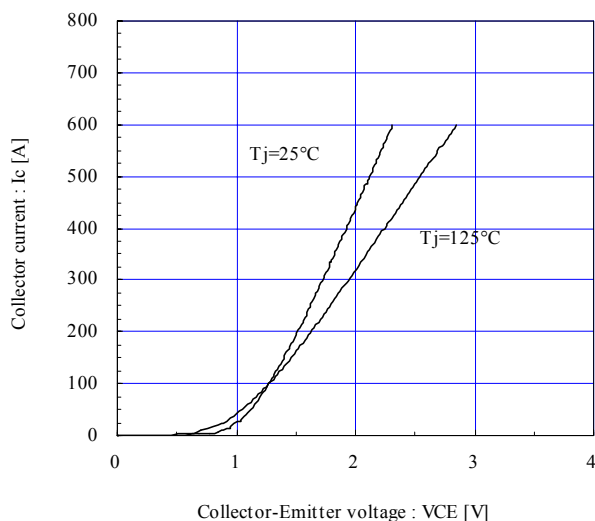

Collector-Emitter voltage vs. Gate-Emitter voltage (typ.)  
T<sub>j</sub>=25°C / chip

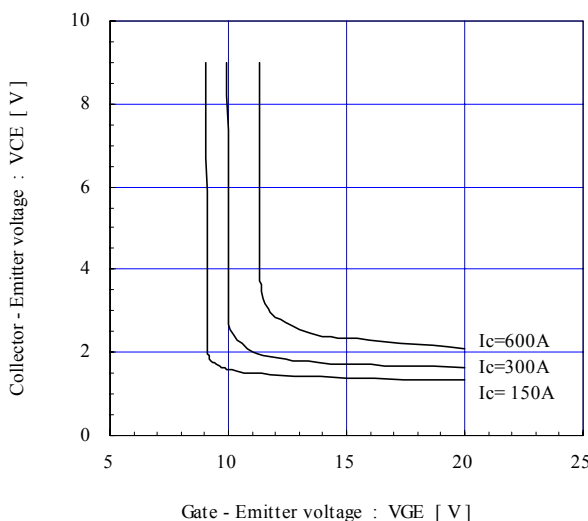

Capacitance vs. Collector-Emitter voltage (typ.)  
VGE=0V, f= 1MHz, Tj= 25°C

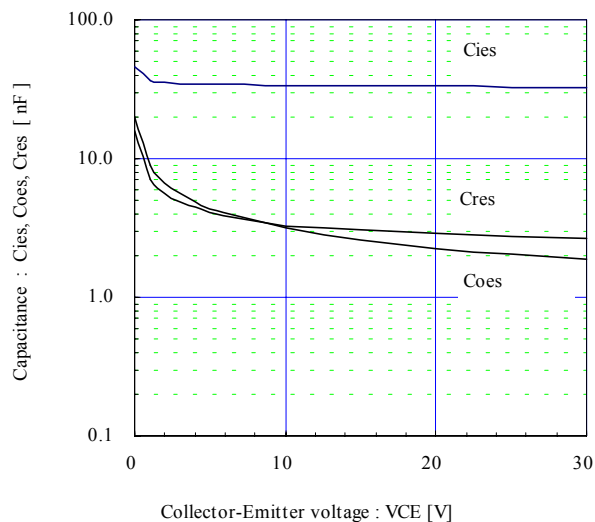

Dynamic Gate charge (typ.)  
Vcc=600V, Ic=300A, Tj= 25°C

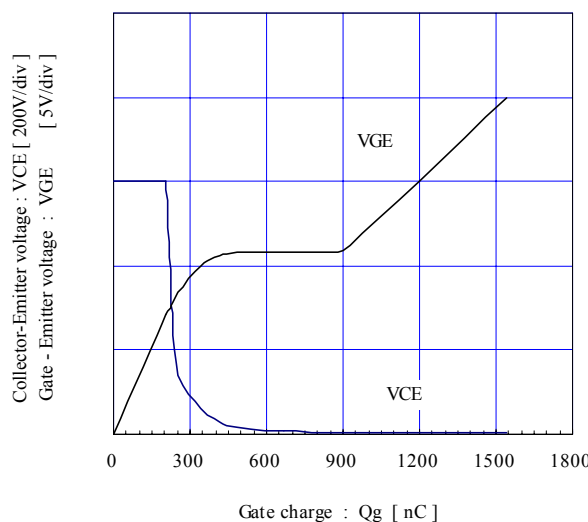

Switching time vs. Collector current (typ.)

V<sub>cc</sub>=600V, V<sub>GE</sub>=±15V, R<sub>g</sub>=2Ω, T<sub>j</sub>= 25°C

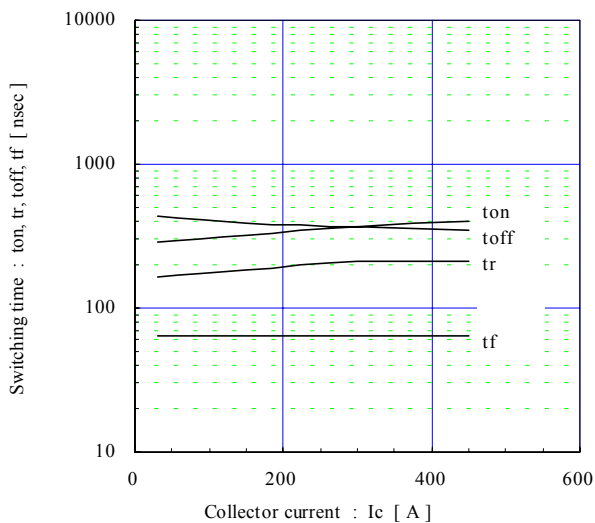

Switching time vs. Collector current (typ.)

V<sub>cc</sub>=600V, V<sub>GE</sub>=±15V, R<sub>g</sub>=2Ω, T<sub>j</sub>=125°C

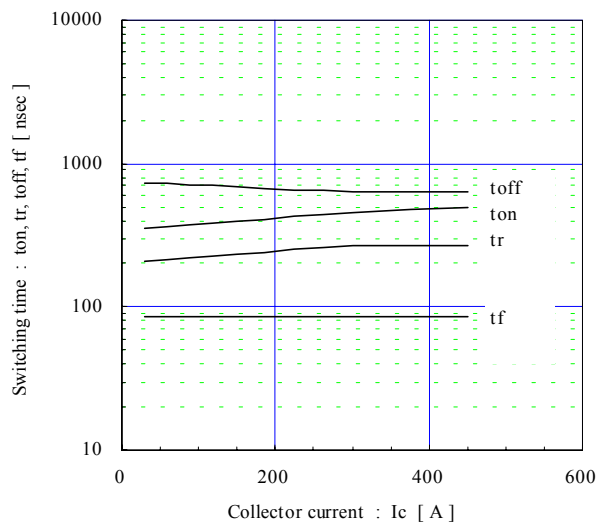

Switching time vs. Gate resistance (typ.)

V<sub>cc</sub>=600V, Ic=300A, V<sub>GE</sub>=±15V, T<sub>j</sub>= 25°C

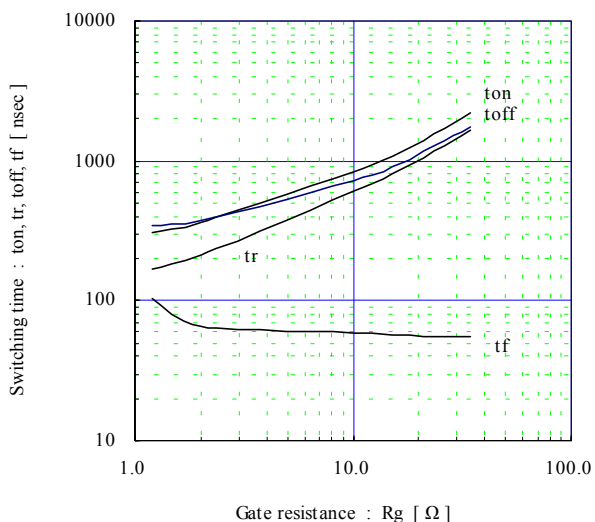

Switching loss vs. Collector current (typ.)

V<sub>cc</sub>=600V, V<sub>GE</sub>=±15V, R<sub>g</sub>=2Ω

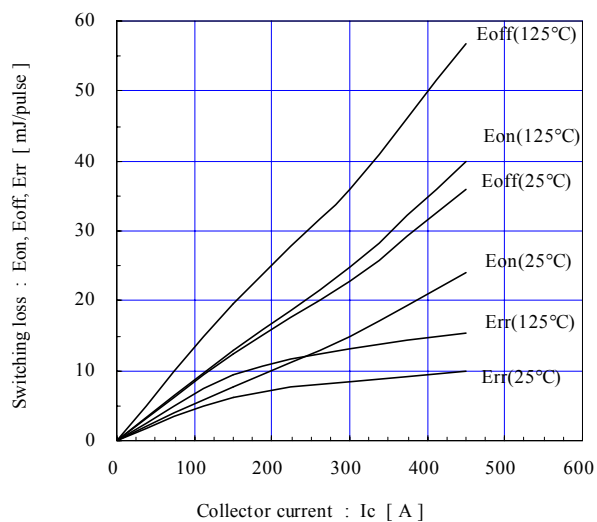

Switching loss vs. Gate resistance (typ.)

V<sub>cc</sub>=600V, Ic=300A, V<sub>GE</sub>=±15V, T<sub>j</sub>= 125°C

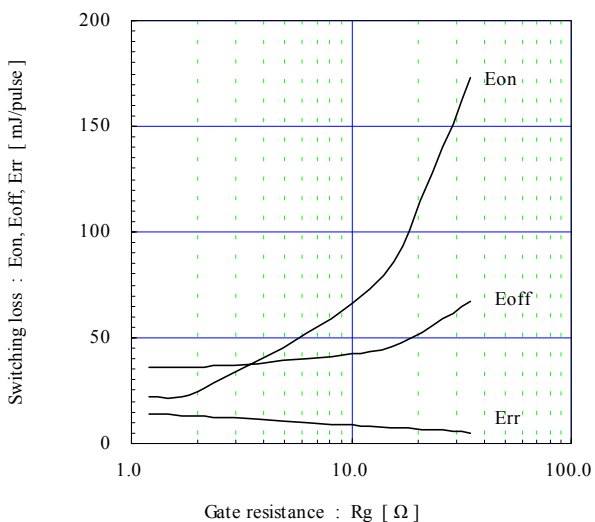

Reverse bias safe operating area (max.)

+V<sub>GE</sub>=15V, -V<sub>GE</sub> ≤ 15V, R<sub>G</sub> ≥ 2Ω, T<sub>j</sub> ≤ 125°C

Stray inductance ≤ 100nH

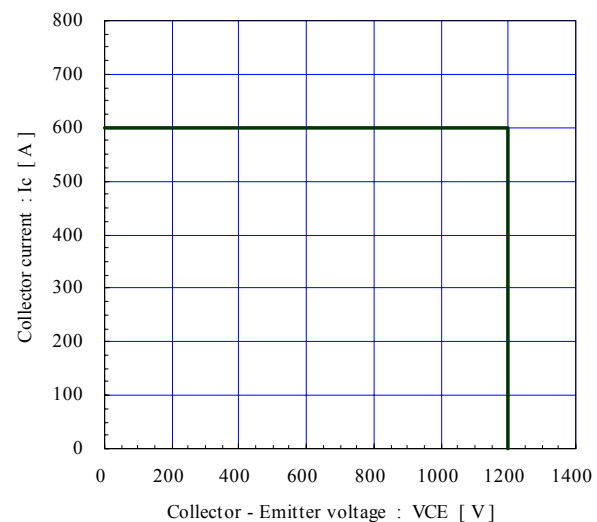

Forward current vs. Forward on voltage (typ.)  
chip

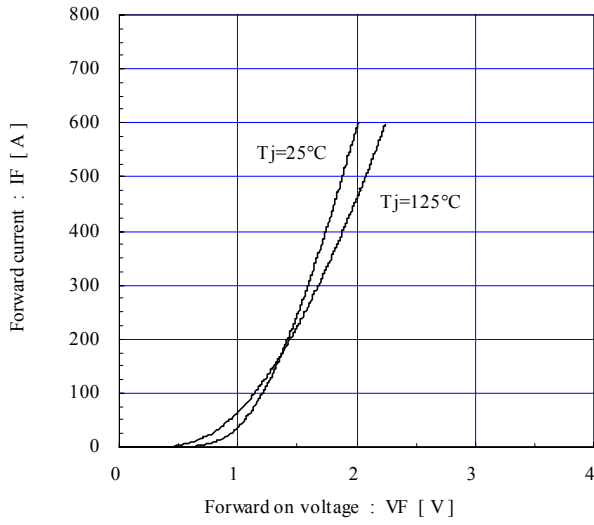

Reverse recovery characteristics (typ.)

$V_{cc}=600\text{V}$ ,  $V_{GE}=\pm 15\text{V}$ ,  $R_g=2\Omega$

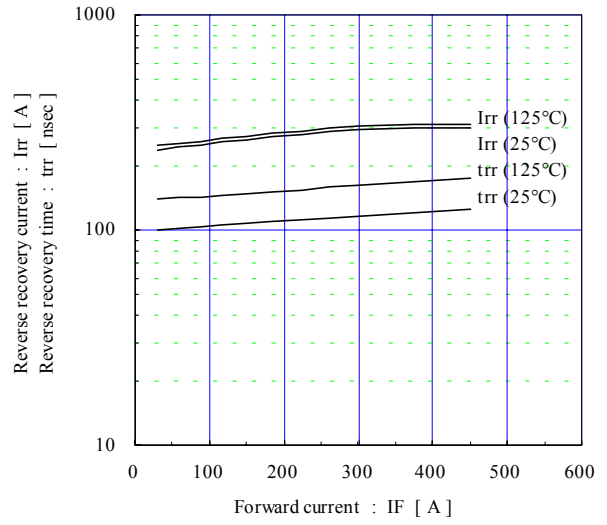

Transient thermal resistance (max.)

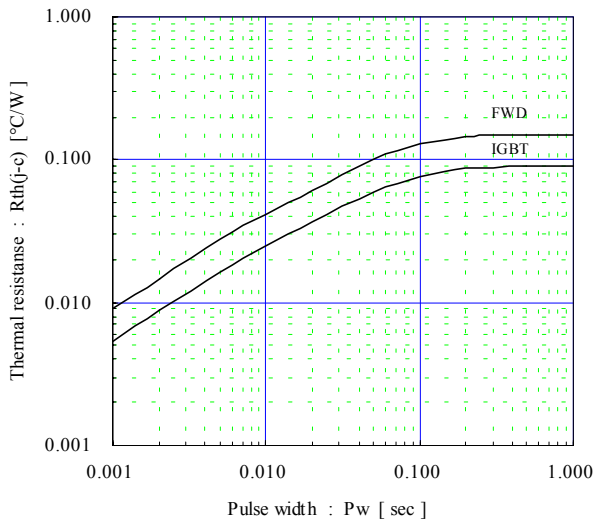

Temperature characteristic (typ.)

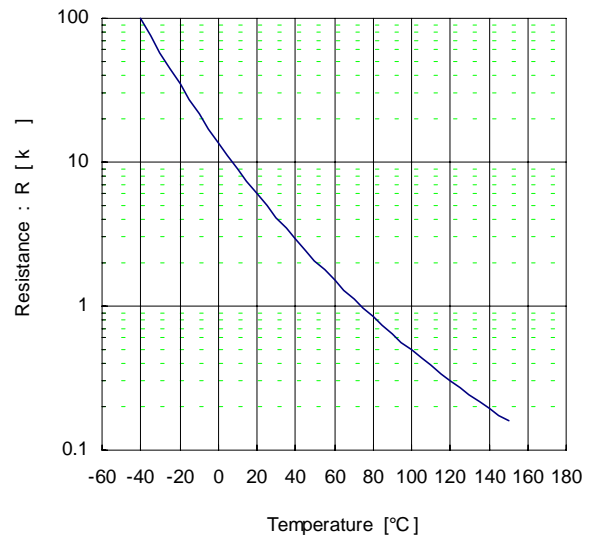

Outline Drawings, mm

M629

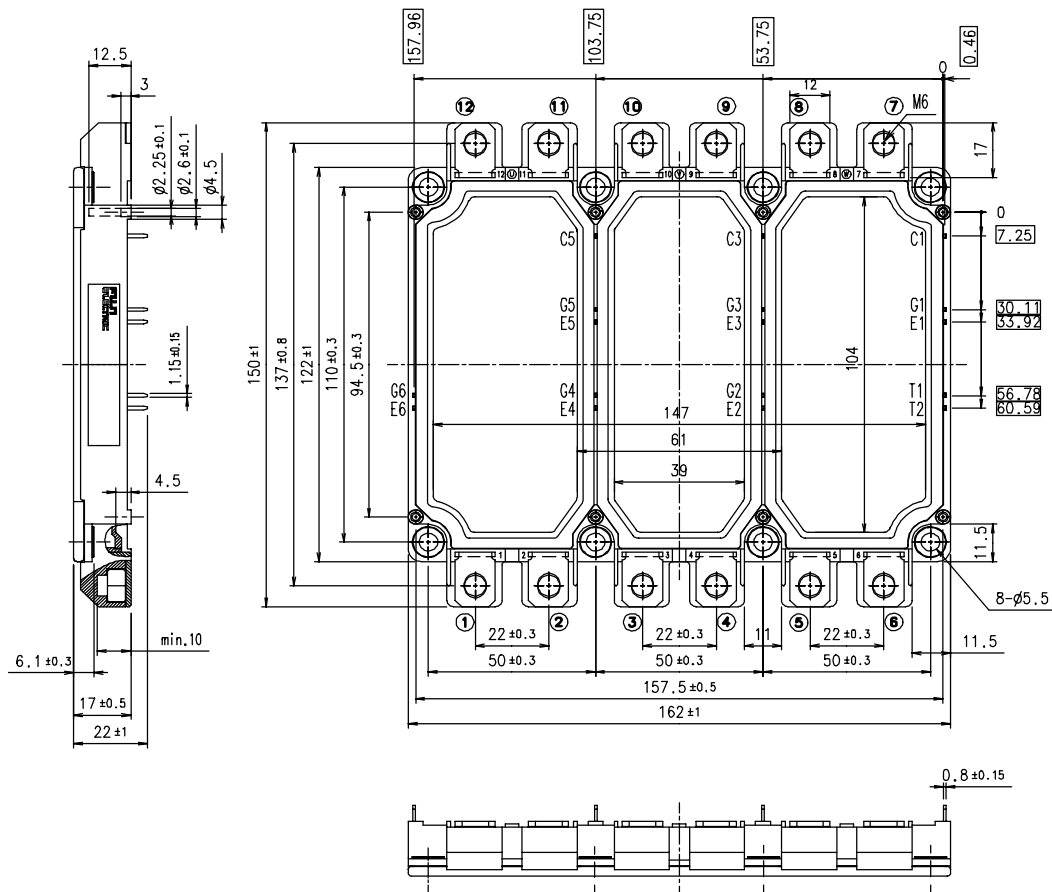

NOTE)   shows theoretical dimension and tolerance is  $\pm 0.5$  .

Equivalent Circuit Schematic

