

**TGM-18-2003**

## **Module Amplifier**

### **2 GHz - 18 GHz**

This Module Amplifier offers exceptional performance over the band 2 GHz to 18 GHz with 15.0 dBm P1dB output power and 10.0 dB Gain.

Teledyne Microwave amplifiers are balanced or feedback designs and manufactured with the latest MIC & MMIC technology. The GaAs FET's used in these amplifiers are well established proven devices from multiple sources.

Teledyne Microwave offers a complete line of Narrow and broadband Amplifiers covering the frequency range 500 MHz to 40 GHz. These products are available in either connectorized packages or as modules. For a complete list of these products and more, please visit our website.

Other products from Teledyne Microwave include: Transceivers, Synthesizers, and YIG Products



---

#### Specifications:

Model Number: TGM-18-2003  
Frequency Range: 2 GHz – 18 GHz  
Gain (min): 10.0 dB  
Gain Vs Temp Coefficient per 1 deg C: -0.022 dB  
Noise Figure (max): 9.5 dB  
Output Power @ 1dB Compression: 15.0 dBm  
Gain Flatness Vs Frequency: +/-0.8 dB  
3<sup>rd</sup> Order Intercept (Typ): Contact Factory  
Power Supply:  
    Input Voltage: 11.5 to 15 VDC  
    Current @ 12 VDC (typ): 220 mA  
    Current @ 12 VDC (max): Contact Factory  
Case Type (See attached Outline): 1248NP  
Temperature Range: +25C



**ISO 9001:2000**

1274 Terra Bella Avenue, Mountain View, CA 94043 • PHN# 800.832.6869 or +1.650.962.6944 • FAX# 650.962.6845  
www.teledynemicrowave.com • microwave@teledyne.com

TGM-18-2003

# Module Amplifier

## 2 GHz - 18 GHz

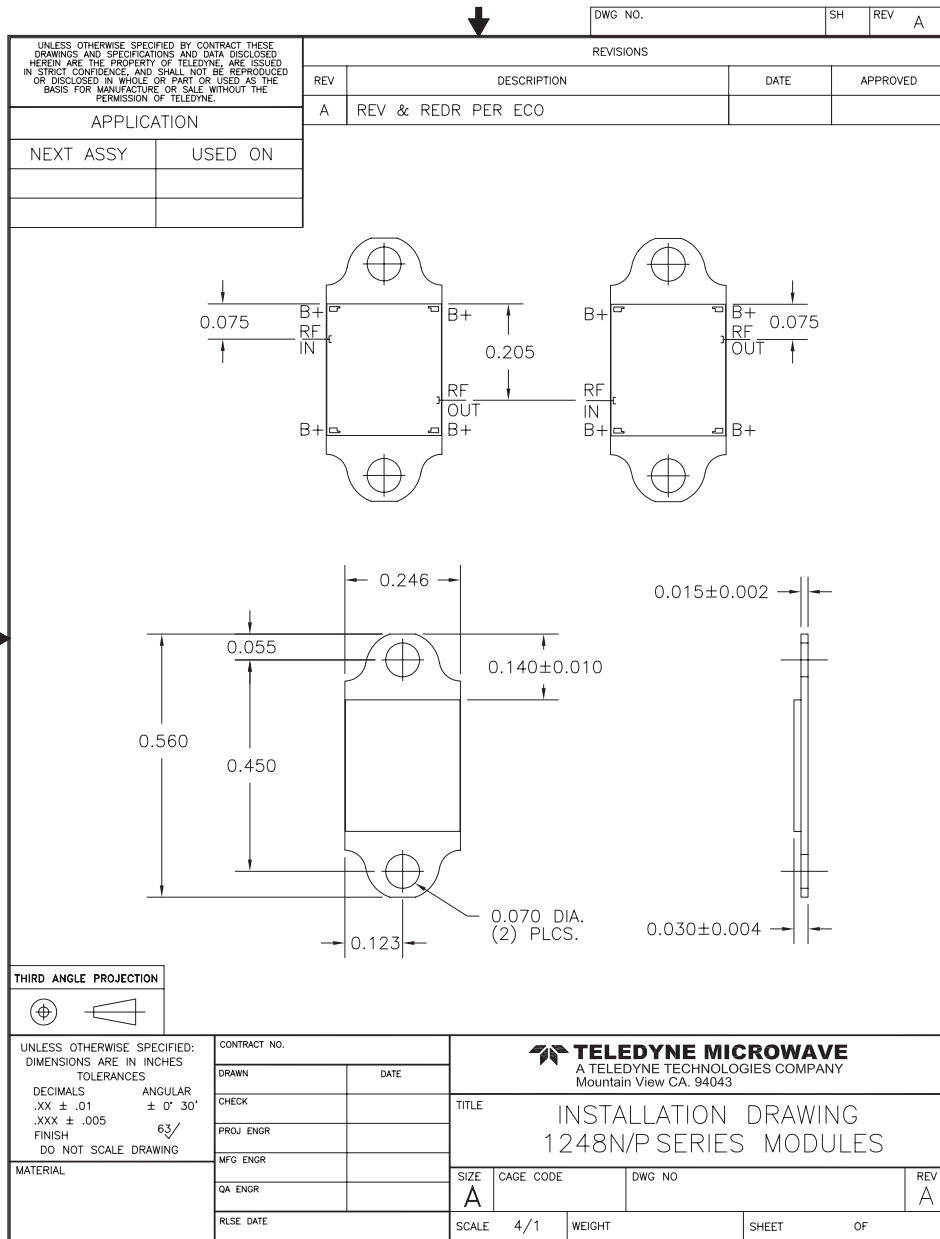

ISO 9001:2000

1274 Terra Bella Avenue, Mountain View, CA 94043 • PHN# 800.832.6869 or +1.650.962.6944 • FAX# 650.962.6845  
www.teledynemicrowave.com • microwave@teledyne.com