

Low Dropout LED Driver for any Color LED

FEATURES

- LED Drivers for parallel connected LEDs
- Low Dropout Voltage(<300mV) to support direct Li-ion applications
- No EMI, no switching noise
- No external components needed for current matching
- PWM and Analog brightness control
- 160mA bias current (up to 80mA for each LED)
- Enable/Shutdown control
- Shutdown current < 1 μ A
- Small footprint SC-70 Package

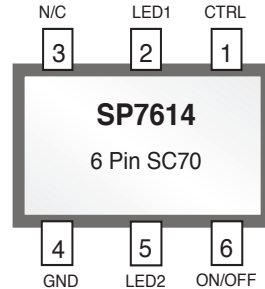

APPLICATIONS

- Next Generation Mobile Phones
- PDA, DSC, MP3 players
- Handheld Computers
- LCD Display Modules
- Keyboard Backlight
- LED Displays

DESCRIPTION

The SP7614 driver family provides matched current source bias for white, blue or any color LEDs. The current in the LEDs can be programmed by an external resistor. The Individual LED currents are $200 \times I_{SET}$, where I_{SET} is the current through the external resistor connected to the CTRL pin. The SP7614 is designed to drive two high current LEDs. The SP7614 is offered in a 6-pin SC-70 package.

TYPICAL APPLICATION SCHEMATIC

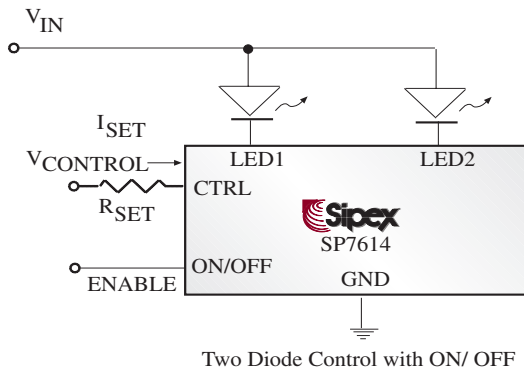

ABSOLUTE MAXIMUM RATINGS

V_{I1} , V_{I2} , V_{I3} , V_{I4} and EN Voltage to GND -0.3V to 6V
 CTRL Voltage to GND 0.5V
 Output Current (I_{OUT}) 80mA
 Power Dissipation per Package - 6-pin SC-70 at $T_A = 85^\circ\text{C}$ 190mW
 Junction Temperature $+150^\circ\text{C}$
 Storage Temperature -55°C to $+150^\circ\text{C}$
 ESD Level. 4kV HBM

These are stress ratings only and functional operation of the device at these ratings or any other above those indicated in the operation sections of the specifications below is not implied. Exposure to absolute maximum rating conditions for extended periods of time may affect reliability.

ELECTRICAL SPECIFICATIONS

Specifications are at $T_A = 25^\circ\text{C}$, $V_{IN} = 3.3$ to 5.5 , $\text{ENABLE} = V_{IN}$, ♦ denotes the specifications which apply over the full operating temperature range, unless otherwise specified.

PARAMETER	MIN.	TYP.	MAX.	UNITS		CONDITIONS
Output Current Multiplication Ratio	140	200	260	mA	♦	$V_{SAT} = 150\text{mA}$ $I_{CTRL} = 100\mu\text{A}$
LED Current (Per Diode)		20		mA	♦	$V_{SAT} = 150\text{mA}$ $I_{CTRL} = 100\mu\text{A}$
LED to LED Current Matching	-3		3	%	♦	No Load
Peak Efficiency		90		%	♦	
Current in OFF Mode			1	μA	♦	
Min. ENABLE "ON Voltage"			3	V	♦	
Max. ENABLE "OFF Voltage"	0.5			V	♦	

PIN DESCRIPTION

PIN NUMBER	PIN NAME	DESCRIPTION
1	CTRL	Sets LED Current.
2	LED1	Connect to Cathode of LED.
3	N/C	No Connect.
4	GND	Ground.
5	LED2	Connect to Cathode of LED.
6	ON/OFF	Chip ON/OFF/Disable.

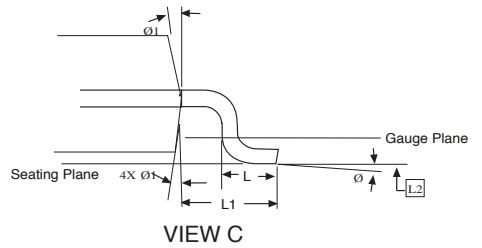
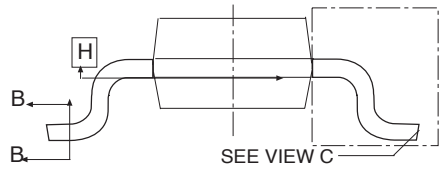
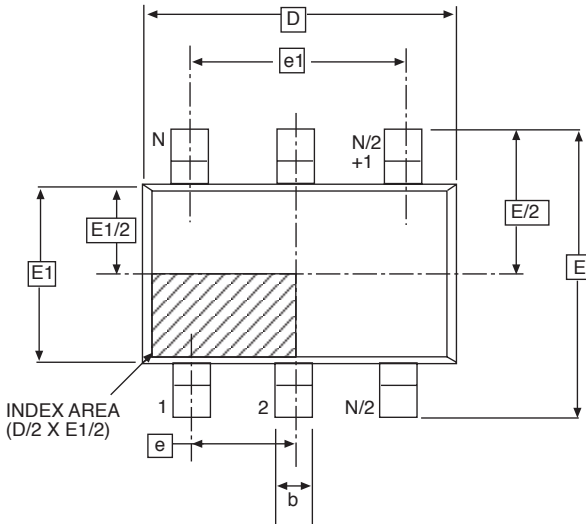

Dimensions in (mm)	6 PIN SC-70 JEDEC MO-203 (AB) Variation		
	MIN	NOM	MAX
A	-	-	1.10
A1	0	-	0.10
A2	0.70	0.90	1.00
b	0.15	-	0.30
c	0.08	-	0.22
D	2.00 BSC		
E	2.10 BSC		
E1	1.25 BSC		
L	0.26	0.36	0.46
L1	0.42 REF		
L2	0.15 BSC		
Ø	0°	4°	8°
Ø1	4°	-	12°

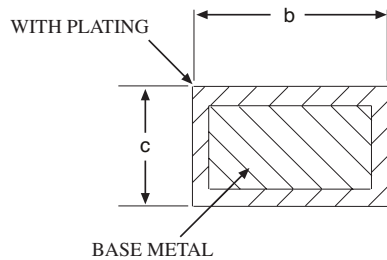
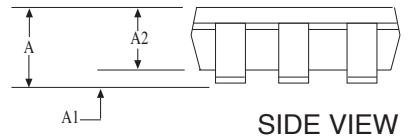

6 PIN SC-70

ORDERING INFORMATION

Part Number	Operating Temperature Range	Package Type
SP7614C6	-40°C to +85°C	6 Pin SC-70
SP7614C6/TR	-40°C to +85°C	(Tape & Reel) 6 Pin SC-70



ANALOG EXCELLENCE

Sipex Corporation

**Headquarters and
Sales Office**

233 South Hillview Drive
Milpitas, CA 95035
TEL: (408) 934-7500
FAX: (408) 935-7600

Sales Office

22 Linnell Circle
Billerica, MA 01821
TEL: (978) 667-8700
FAX: (978) 670-9001
e-mail: sales@sipex.com

Sipex Corporation reserves the right to make changes to any products described herein. Sipex does not assume any liability arising out of the application or use of any product or circuit described herein; neither does it convey any license under its patent rights nor the rights of others.