

**Features**

- 2.8mm(L)×1.2mm(W) small size surface mount type
- Thin package of 0.8mm(H) thickness
- Transparency SMD side view type
- Wide viewing angle : 110°
- **E ; ESD Protected (±2.0KV, 3 Times @100pF, 1.5KΩ)**

**Outline Dimensions**

**unit : mm**

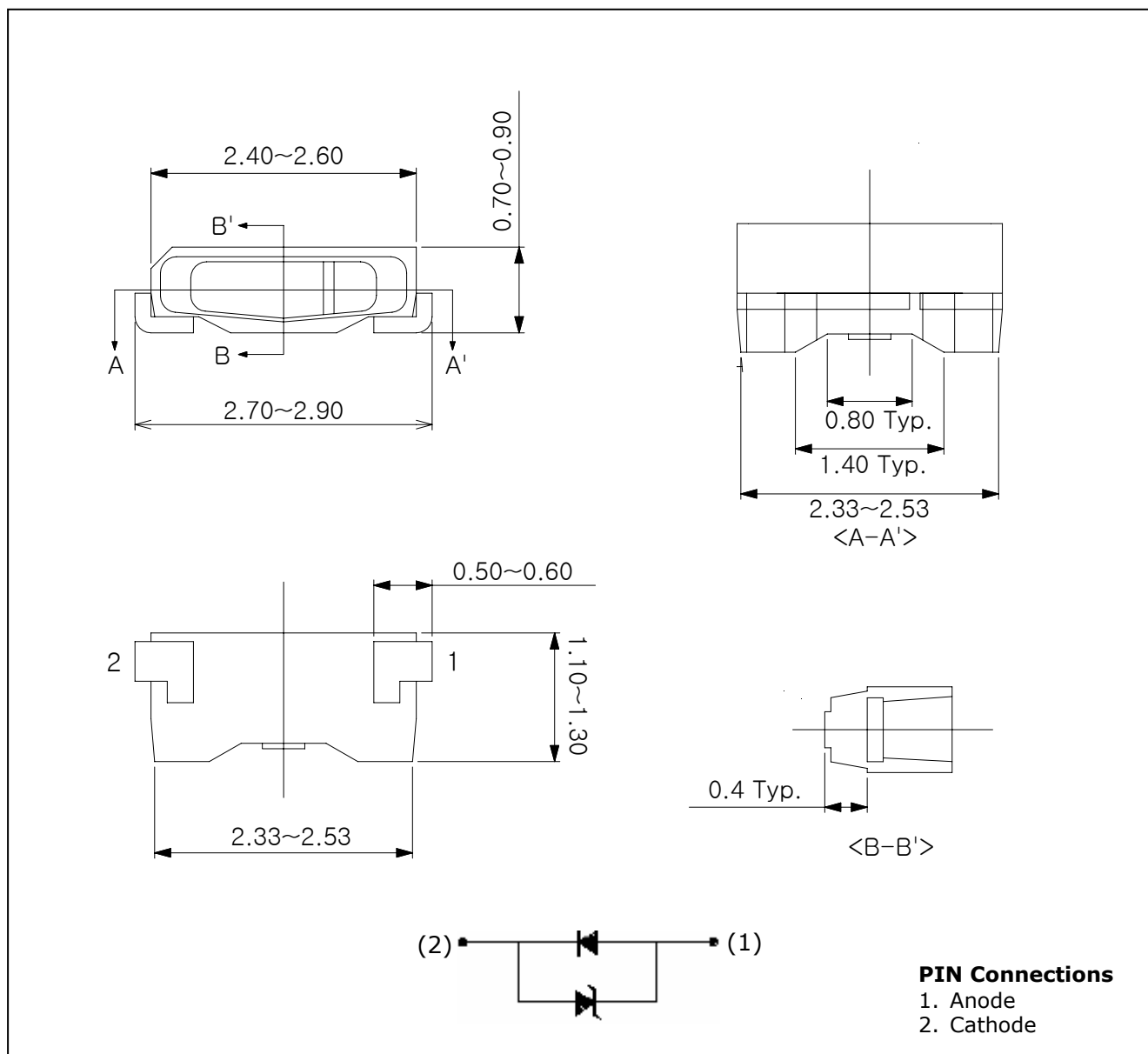

## Absolute Maximum Ratings

(Ta=25°C)

Characteristic	Symbol	Rating	Unit
Power dissipation	$P_D$	90	mW
Forward current	$I_F$	25	mA
*1 Peak forward current	$I_{FP}$	50	mA
Operating temperature range	$T_{opr}$	-30~85	°C
Storage temperature range	$T_{stg}$	-40~100	°C
*2 Soldering temperature	$T_{sol}$	240°C for 10 seconds	

\*1. Duty ratio = 1/16, Pulse width = 0.1ms

\*2. Recommended reflow soldering temperature profile

- Preheating 150°C to 185°C within 120 seconds soldering 240°C within 10 seconds
- Gradual cooling (Avoid quenching)

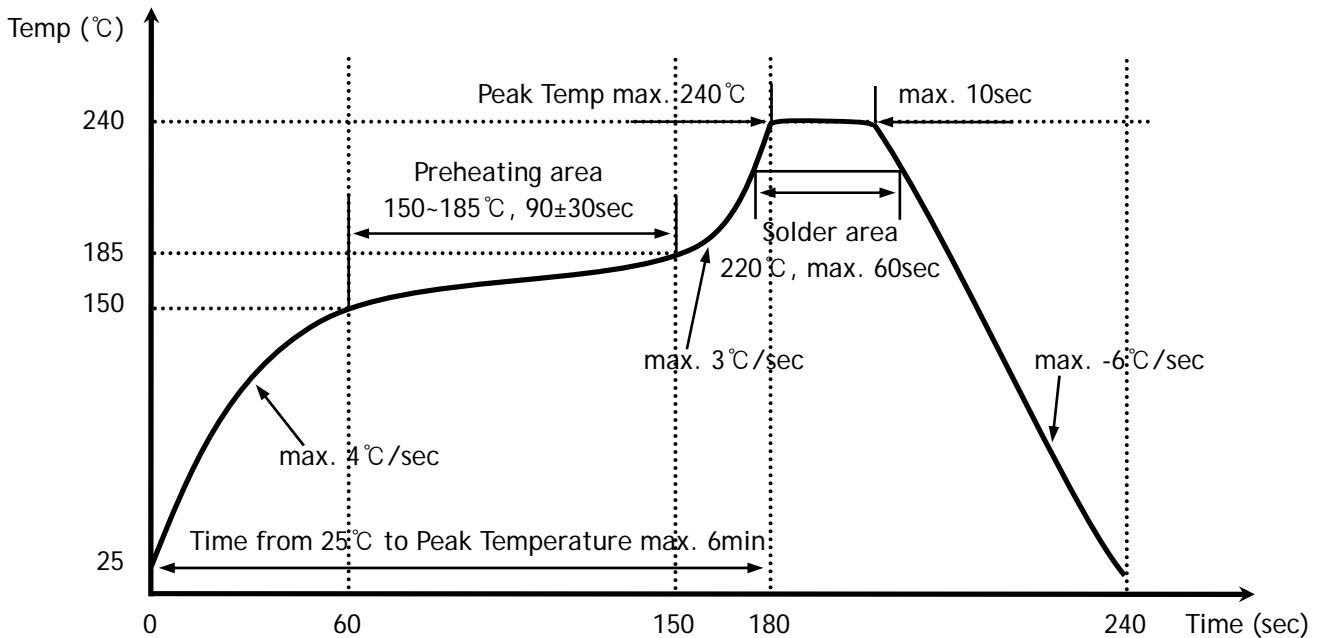

## Electrical / Optical Characteristics

(Ta=25°C)

Characteristic	Symbol	Test Condition	Min	Typ	Max	Unit
Forward voltage	$V_F$	$I_F= 20mA$	3.0	-	3.6	V
*3 Luminous intensity	$I_V$	$I_F= 20mA$	68	-	230	mcd
Dominant wavelength	$\lambda_D$	$I_F= 20mA$	460	465	470	nm
Spectrum bandwidth	$\Delta\lambda$	$I_F= 20mA$	-	35	-	nm
*4 Half angle	$\theta_{1/2}$	$I_F= 20mA$		±55		deg

\*3. Luminous intensity maximum tolerance for each grade classification limit is  $\pm 18\%$   
(The test result of  $I_F=20\text{mA}$  is only for reference)

\*4.  $\theta_{1/2}$  is the off-axis angle where the luminous intensity is 1/2 the peak intensity

●  $V_F / I_V / \lambda_D$  Grade Classification ( $T_a=25^\circ\text{C}$ )

Test Condition @ $I_F = 20\text{mA}$		
Forward Voltage [V]	Luminous Intensity [mcd]	Dominant Wavelength [nm]
1 : 3.0~3.3	K : 68~100	a : 460~465
	L : 100~155	
2 : 3.3~3.6	M : 155~230	b : 465~470

(Do not use to combine grade classification. It must be used separately grade classification)

Characteristic Diagrams

Fig. 1  $I_F - V_F$

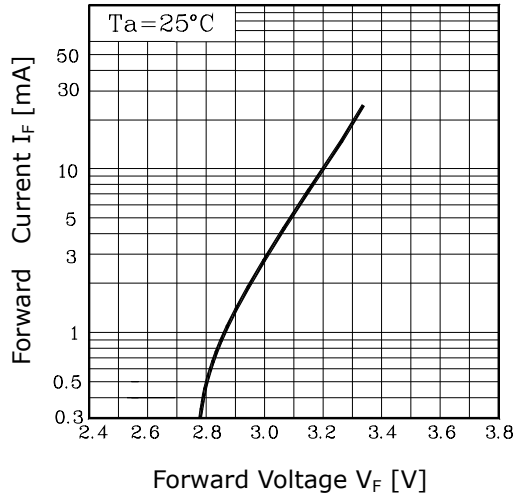

Fig. 2  $I_V - I_F$

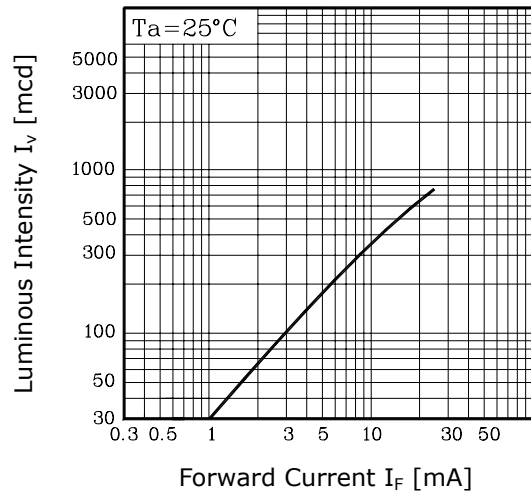

Fig. 3  $I_F - T_a$

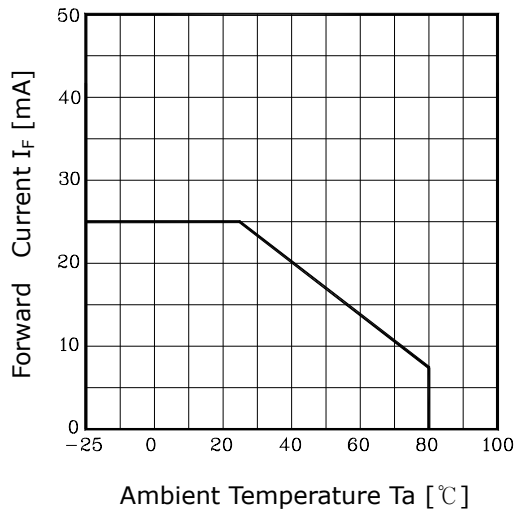

Fig.4 Spectrum Distribution

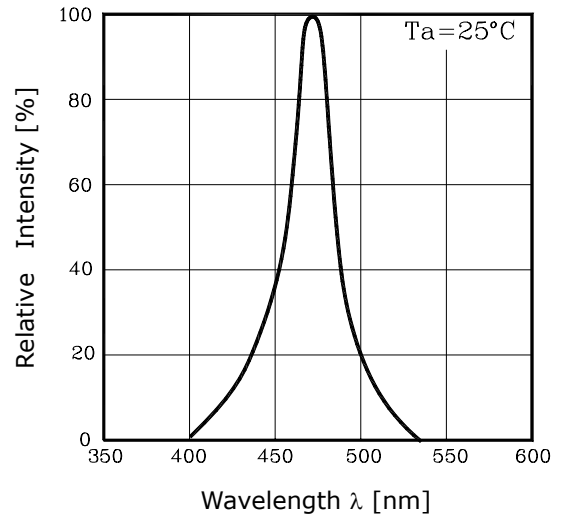
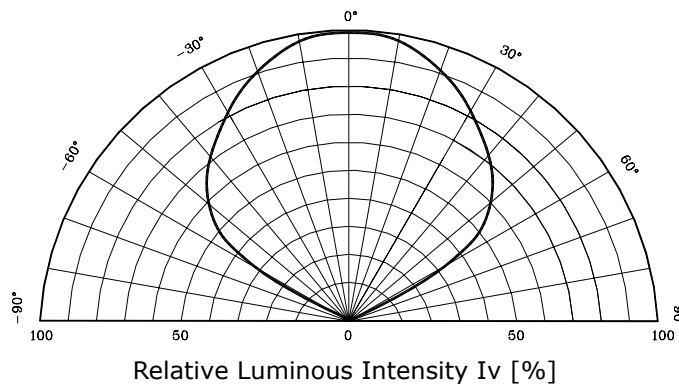

Fig. 5-1 Radiation Diagram(X)



**The AUK Corp. products are intended for the use as components in general electronic equipment (Office and communication equipment, measuring equipment, home appliance, etc.).**

**Please make sure that you consult with us before you use these AUK Corp. products in equipments which require high quality and / or reliability, and in equipments which could have major impact to the welfare of human life(atomic energy control, airplane, spaceship, transportation, combustion control, all types of safety device, etc.). AUK Corp. cannot accept liability to any damage which may occur in case these AUK Corp. products were used in the mentioned equipments without prior consultation with AUK Corp..**

**Specifications mentioned in this publication are subject to change without notice.**