



PD55008L

RF POWER TRANSISTORS

The LdmoST Plastic FAMILY

ADVANCED DATA

N-CHANNEL ENHANCEMENT-MODE LATERAL MOSFETs

- EXCELLENT THERMAL STABILITY
- COMMON SOURCE CONFIGURATION
- $P_{OUT} = 8\text{ W}$ with 17 dB gain @ 500 MHz / 12.5V
- INTEGRATED ESD PROTECTION
- NEW LEADLESS PLASTIC PACKAGE
- SUPPLIED IN TAPE & REEL OF 3K UNITS

DESCRIPTION

The PD55008L is a common source N-Channel, enhancement-mode lateral Field-Effect RF power transistor. It is designed for high gain, broad band commercial and industrial applications. It operates at 12 V in common source mode at frequencies up to 1 GHz.

PD55008L boasts the excellent gain, linearity and reliability of STH1LV latest LDMOS technology mounted in the innovative leadless SMD plastic package, PowerFLAT™. PD55008L's superior linearity performance makes it an ideal solution for car mobile radio.

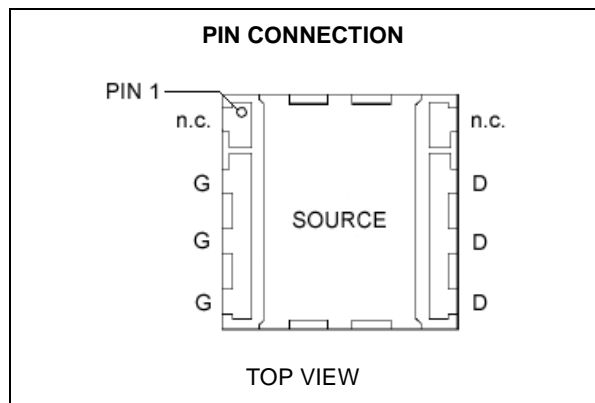
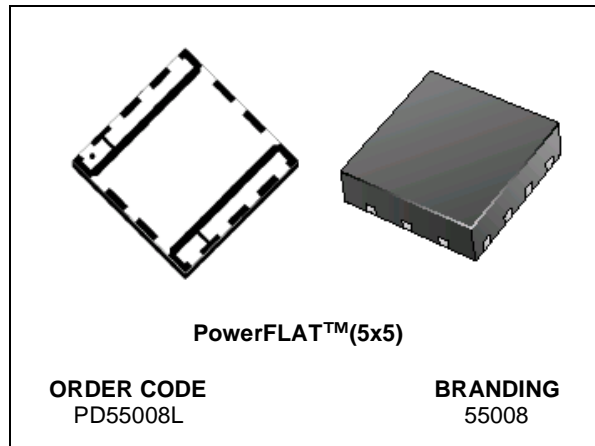

ABSOLUTE MAXIMUM RATINGS ($T_{CASE} = 25\text{ }^{\circ}\text{C}$)

Symbol	Parameter	Value	Unit
$V_{(BR)DSS}$	Drain-Source Voltage	40	V
V_{GS}	Gate-Source Voltage	-0.5 to 15	V
I_D	Drain Current	5	A
P_{DISS}	Power Dissipation (@ $T_c = 70\text{ }^{\circ}\text{C}$)	19.5	W
T_j	Max. Operating Junction Temperature	150	$^{\circ}\text{C}$
T_{STG}	Storage Temperature	-65 to +150	$^{\circ}\text{C}$

THERMAL DATA

$R_{th(j-c)}$	Junction -Case Thermal Resistance	4.1	$^{\circ}\text{C}/\text{W}$
---------------	-----------------------------------	-----	-----------------------------

ELECTRICAL SPECIFICATION ($T_{CASE} = 25\text{ }^{\circ}\text{C}$)

STATIC

Symbol	Test Conditions	Min.	Typ.	Max.	Unit
I_{DSS}	$V_{GS} = 0\text{ V}$ $V_{DS} = 28\text{ V}$			1	μA
I_{GSS}	$V_{GS} = 5\text{ V}$ $V_{DS} = 0\text{ V}$			1	μA
$V_{GS(Q)}$	$V_{DS} = 10\text{ V}$ $I_D = 150\text{ mA}$	2.0		5.0	V
$V_{DS(ON)}$	$V_{GS} = 10\text{ V}$ $I_D = 0.5\text{ A}$		0.13	0.14	V
G_{FS}	$V_{DS} = 10\text{ V}$ $I_D = 1.5\text{ A}$		1.6		mho
C_{ISS}	$V_{GS} = 0\text{ V}$ $V_{DS} = 12.5\text{ V}$ $f = 1\text{ MHz}$		53		pF
C_{OSS}	$V_{GS} = 0\text{ V}$ $V_{DS} = 12.5\text{ V}$ $f = 1\text{ MHz}$		38		pF
C_{RSS}	$V_{GS} = 0\text{ V}$ $V_{DS} = 12.5\text{ V}$ $f = 1\text{ MHz}$		3.2		pF

DYNAMIC

Symbol	Test Conditions	Min.	Typ.	Max.	Unit
P_{OUT}	$V_{DD} = 12.5\text{ V}$ $I_{DQ} = 150\text{ mA}$ $f = 500\text{ MHz}$	8			W
G_P	$V_{DD} = 12.5\text{ V}$ $I_{DQ} = 150\text{ mA}$ $P_{OUT} = 8\text{ W}$ $f = 500\text{ MHz}$	17	19		dB
η_D	$V_{DD} = 12.5\text{ V}$ $I_{DQ} = 150\text{ mA}$ $P_{OUT} = 8\text{ W}$ $f = 500\text{ MHz}$	55	63		%
Load mismatch	$V_{DD} = 15.5\text{ V}$ $I_{DQ} = 150\text{ mA}$ $P_{OUT} = 8\text{ W}$ $f = 500\text{ MHz}$ ALL PHASE ANGLES	20:1			VSWR

ESD PROTECTION CHARACTERISTICS

Test Conditions	Class
Human Body Model	2
Machine Model	M3

MOISTURE SENSITIVITY LEVEL

Test Methodology	Rating
J-STD-020B	MSL 3

TYPICAL PERFORMANCE

Capacitance Vs Supply Voltage

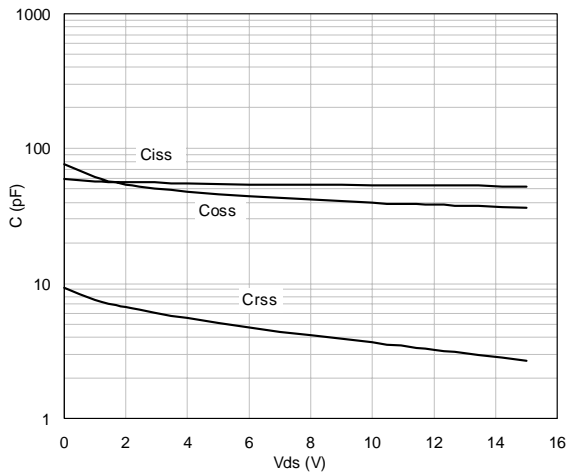

Output Power Vs Input Power

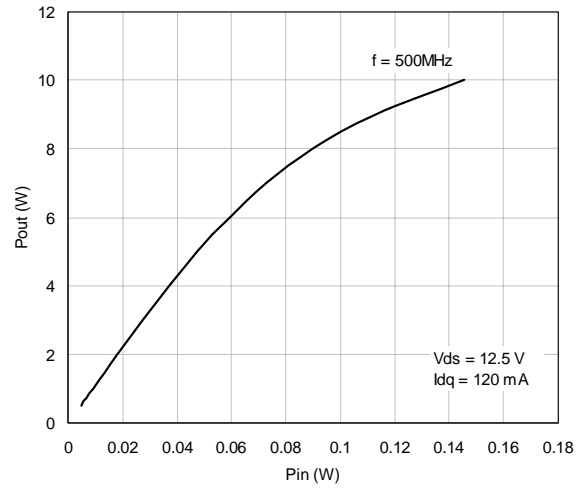

Power Gain Vs Output Power

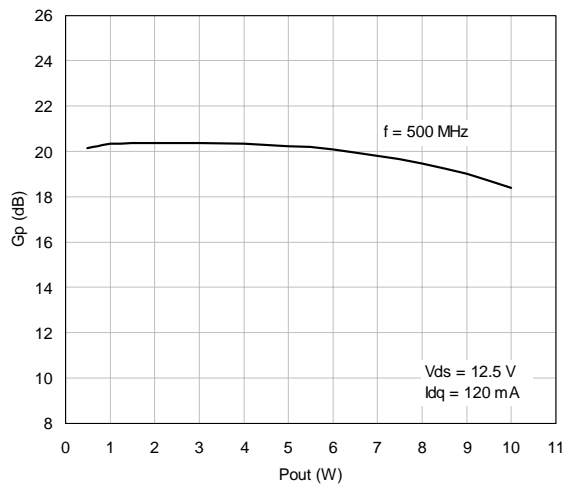

Efficiency Vs Output Power

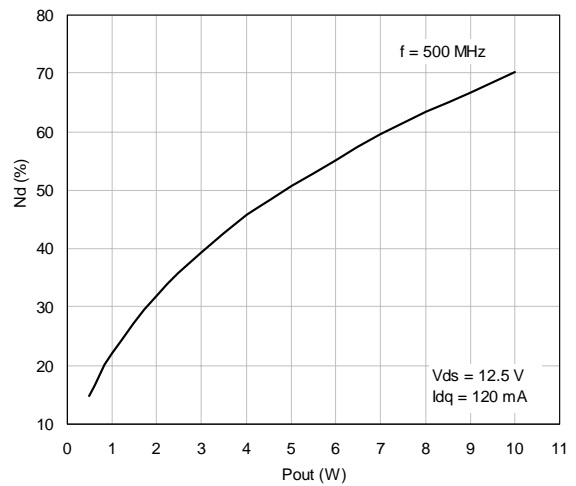

Input Return Loss Vs Output Power

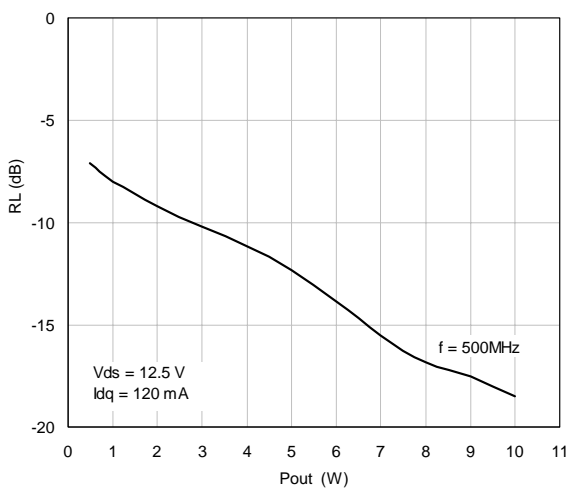

PD55008L**S-PARAMETER (PD55008L)** $(V_{DS} = 12.5V \quad I_{DS} = 0.15A)$

FREQ (MHz)	$ S_{11} $	$\angle S_{11}$	$ S_{21} $	$\angle S_{21}$	$ S_{12} $	$\angle S_{12}$	$ S_{22} $	$\angle S_{22}$
50	0.783	-134	16.75	100	0.034	11	0.654	-135
100	0.774	-153	8.73	82	0.034	-6	0.667	-150
150	0.791	-159	5.61	70	0.033	-15	0.698	-155
200	0.814	-163	4.00	61	0.029	-22	0.737	-157
250	0.838	-165	3.00	54	0.027	-28	0.775	-159
300	0.862	-166	2.34	47	0.023	-32	0.806	-161
350	0.879	-168	1.87	41	0.021	-35	0.837	-163
400	0.894	-169	1.52	37	0.018	-37	0.861	-164
450	0.908	-171	1.26	32	0.015	-37	0.881	-166
500	0.919	-172	1.06	28	0.013	-37	0.900	-167
550	0.927	-173	0.91	25	0.010	-36	0.911	-168
600	0.937	-174	0.78	22	0.009	-33	0.917	-169
650	0.942	-175	0.68	19	0.007	-20	0.931	-170
700	0.945	-176	0.60	16	0.005	-7	0.938	-171
750	0.948	-177	0.53	14	0.005	14	0.940	-172
800	0.953	-178	0.47	12	0.006	36	0.950	-173
850	0.956	-179	0.42	10	0.007	48	0.954	-173
900	0.956	-179	0.38	9	0.007	60	0.957	-174
950	0.957	180	0.34	7	0.009	66	0.960	-175
1000	0.957	179	0.31	6	0.010	71	0.960	-176
1050	0.958	178	0.28	4	0.012	73	0.960	-176
1100	0.959	177	0.26	3	0.013	75	0.967	-177
1150	0.960	177	0.24	2	0.014	73	0.967	-177
1200	0.959	176	0.22	1	0.015	79	0.966	-178
1250	0.958	176	0.20	0	0.017	78	0.970	-178
1300	0.957	175	0.19	-1	0.019	78	0.970	-179
1350	0.956	174	0.18	-2	0.020	78	0.971	-180
1400	0.954	174	0.16	-3	0.020	80	0.971	-180
1450	0.952	173	0.15	-4	0.022	80	0.968	180
1500	0.951	173	0.14	-5	0.023	81	0.970	179

S-PARAMETER (PD55008L)(V_{DS} = 12.5V I_{DS} = 0.8A)

FREQ (MHz)	S ₁₁	S ₁₁ ∠Φ	S ₂₁	S ₂₁ ∠Φ	S ₁₂	S ₁₂ ∠Φ	S ₂₂	S ₂₂ ∠Φ
50	0.828	-147	19.60	97	0.023	11	0.691	-154
100	0.822	-162	10.11	84	0.023	-1	0.714	-164
150	0.829	-167	6.61	75	0.022	-7	0.729	-166
200	0.839	-169	4.82	68	0.021	-11	0.749	-167
250	0.852	-170	3.71	62	0.019	-16	0.772	-167
300	0.866	-171	2.97	56	0.017	-17	0.793	-168
350	0.877	-172	2.43	51	0.015	-18	0.815	-168
400	0.887	-173	2.02	46	0.014	-18	0.833	-169
450	0.898	-174	1.71	42	0.012	-16	0.852	-169
500	0.907	-175	1.47	38	0.010	-12	0.871	-170
550	0.916	-175	1.27	34	0.009	-10	0.879	-170
600	0.923	-176	1.10	31	0.008	1	0.887	-172
650	0.929	-177	0.98	27	0.007	12	0.904	-172
700	0.931	-178	0.86	25	0.007	23	0.911	-173
750	0.937	-179	0.77	22	0.008	37	0.916	-173
800	0.942	-179	0.69	20	0.008	44	0.928	-174
850	0.948	-180	0.62	17	0.009	53	0.933	-174
900	0.946	180	0.56	15	0.010	61	0.936	-175
950	0.948	179	0.51	13	0.011	65	0.940	-176
1000	0.950	178	0.47	12	0.012	67	0.943	-176
1050	0.950	178	0.43	10	0.013	71	0.945	-177
1100	0.953	177	0.39	8	0.016	71	0.951	-177
1150	0.953	176	0.36	7	0.016	72	0.951	-178
1200	0.953	176	0.34	5	0.017	75	0.953	-178
1250	0.952	175	0.31	4	0.019	75	0.958	-179
1300	0.952	175	0.29	3	0.021	75	0.958	-179
1350	0.951	174	0.27	1	0.022	75	0.960	-180
1400	0.951	174	0.25	0	0.023	76	0.960	180
1450	0.949	173	0.23	0	0.024	76	0.959	180
1500	0.950	173	0.21	0	0.025	75	0.960	179

PD55008L**S-PARAMETER (PD55008L)**(V_{DS} = 12.5V I_{DS} = 1.5 A)

FREQ (MHz)	S ₁₁	∠S ₁₁	S ₂₁	∠S ₂₁	S ₁₂	∠S ₁₂	S ₂₂	∠S ₂₂
50	0.835	-145	18.15	98	0.023	11	0.681	-156
100	0.831	-161	9.38	84	0.023	-1	0.711	-164
150	0.837	-166	6.14	75	0.022	-7	0.729	-166
200	0.847	-169	4.47	68	0.020	-11	0.751	-167
250	0.858	-170	3.44	61	0.019	-15	0.773	-168
300	0.872	-171	2.74	55	0.017	-17	0.794	-168
350	0.882	-172	2.24	50	0.015	-17	0.819	-168
400	0.893	-173	1.87	46	0.014	-18	0.837	-169
450	0.904	-174	1.58	41	0.012	-16	0.855	-170
500	0.913	-175	1.35	37	0.010	-13	0.875	-170
550	0.920	-176	1.17	33	0.009	-5	0.881	-170
600	0.927	-177	1.02	30	0.008	1	0.890	-172
650	0.931	-177	0.89	27	0.007	13	0.905	-172
700	0.935	-178	0.79	24	0.007	28	0.914	-173
750	0.940	-179	0.70	22	0.008	41	0.919	-173
800	0.944	-180	0.63	19	0.008	48	0.930	-174
850	0.948	180	0.57	17	0.009	55	0.934	-175
900	0.948	179	0.51	15	0.010	61	0.936	-175
950	0.947	179	0.47	13	0.011	65	0.943	-176
1000	0.949	178	0.43	11	0.013	66	0.943	-176
1050	0.949	177	0.39	10	0.014	70	0.947	-177
1100	0.951	177	0.36	8	0.015	72	0.953	-177
1150	0.951	176	0.33	7	0.016	72	0.955	-178
1200	0.952	176	0.30	5	0.018	74	0.957	-178
1250	0.951	175	0.28	4	0.019	73	0.960	-179
1300	0.950	174	0.26	3	0.021	75	0.959	-179
1350	0.951	174	0.24	2	0.021	75	0.961	-180
1400	0.950	173	0.22	1	0.023	76	0.962	-180
1450	0.948	173	0.21	1	0.024	76	0.960	180
1500	0.949	172	0.20	1	0.025	75	0.963	179

TAPE & REEL DIMENSIONS

	mm		
	MIN.	TYP.	MAX
Ao	5.15	5.25	5.35
Bo	5.15	5.25	5.35
Ko	1.0	1.1	1.2

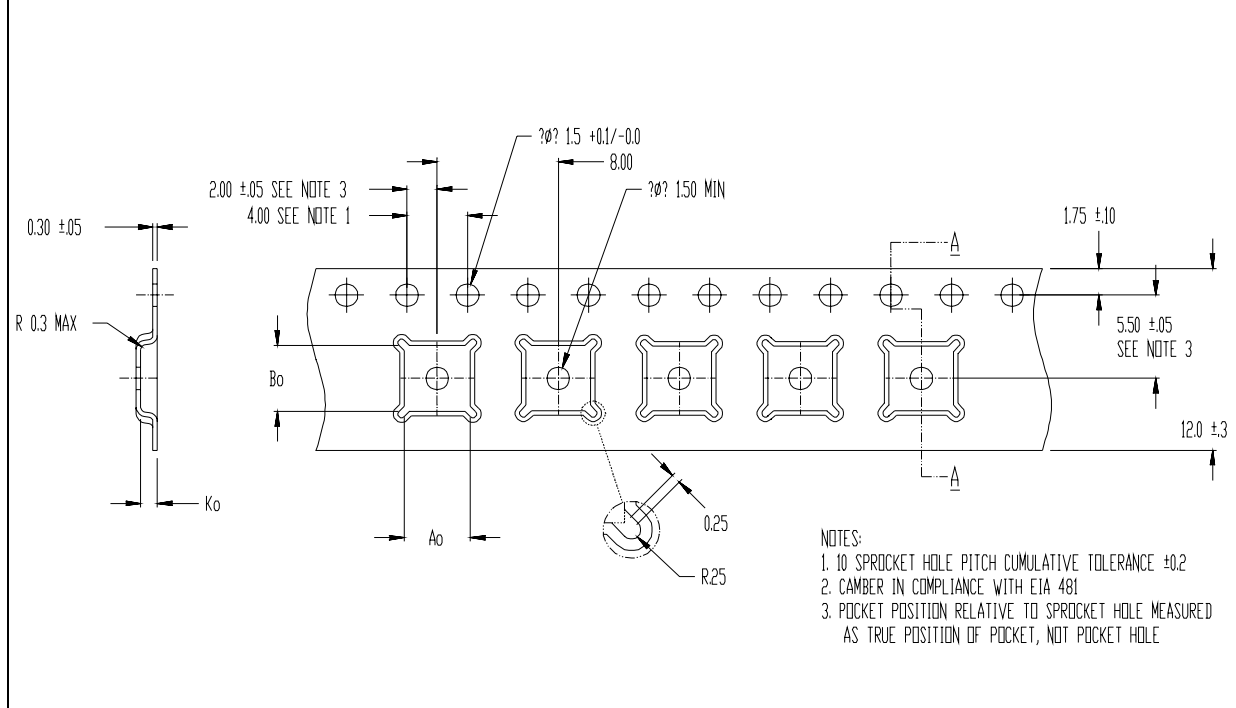

PowerFLAT™ MECHANICAL DATA

DIM.	mm			Inch		
	MIN.	TYP.	MAX	MIN.	TYP.	MAX
A		0.90	1.00		0.035	0.039
A1		0.02	0.05		0.001	0.002
A3		0.24			0.009	
AA	0.15	0.25	0.35	0.006	0.01	0.014
b	0.43	0.51	0.58	0.017	0.020	0.023
c	0.64	0.71	0.79	0.025	0.028	0.031
D		5.00			0.197	
d		0.30			0.011	
E		5.00			0.197	
E2	2.49	2.57	2.64	0.098	0.101	0.104
e		1.27			0.050	
f		3.37			0.132	
g		0.74			0.03	
h		0.21			0.008	

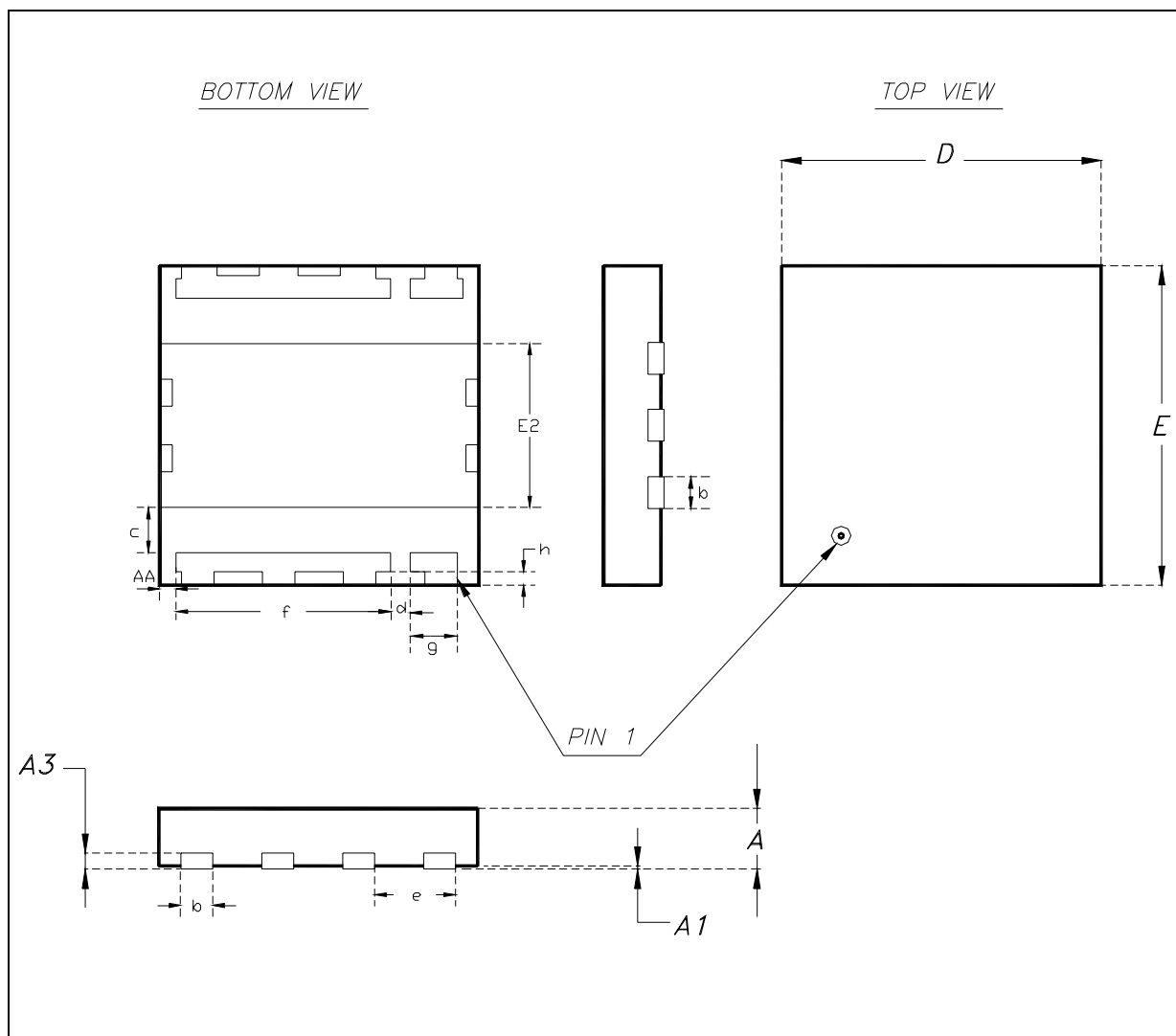

Information furnished is believed to be accurate and reliable. However, STMicroelectronics assumes no responsibility for the consequences of use of such information nor for any infringement of patents or other rights of third parties which may result from its use. No license is granted by implication or otherwise under any patent or patent rights of STMicroelectronics. Specifications mentioned in this publication are subject to change without notice. This publication supersedes and replaces all information previously supplied. STMicroelectronics products are not authorized for use as critical components in life support devices or systems without express written approval of STMicroelectronics.

The ST logo is registered trademark of STMicroelectronics
© 2003 STMicroelectronics - All Rights Reserved

All other names are the property of their respective owners.

STMicroelectronics GROUP OF COMPANIES
Australia - Brazil - Canada - China - Finland - France - Germany - Hong Kong - India - Israel - Italy - Japan -
Malaysia - Malta - Morocco - Singapore - Spain - Sweden - Switzerland - United Kingdom - U.S.A.
<http://www.st.com>