

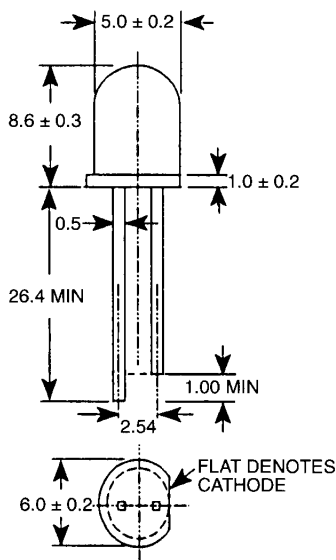

**SUPER BRIGHT T-1 $\frac{3}{4}$  (5 mm)  
LED LAMPS**

**SUPER RED MV8102 CLEAR**  
**SUPER RED MV8103 CLEAR**  
**SUPER RED MV8104 CLEAR**

**PACKAGE DIMENSIONS**



ST1760

**NOTES:**

1. ALL DIMENSIONS ARE IN MILLIMETERS
2. LEAD SPACING IS MEASURED WHERE THE LEADS EMERGE FROM THE PACKAGE
3. PROTRUDED RESIN UNDER FLANGE IS 1.5 mm (0.059") MAX.

**DESCRIPTION**

These T-1 $\frac{3}{4}$  super bright LEDs have a narrow 20° viewing angle for concentrated light output. The MV8101/2/3/4 are made with GaAlAs LEDs on a GaAlAs substrate. They are all encapsulated in an epoxy package and have water clear lenses.

**FEATURES**

- Outstanding material efficiency
- Popular T-1 $\frac{3}{4}$  package
- Low drive current
- Solid state reliability
- Super high brightness suitable for outdoors applications
- Standard 1 mil. lead spacing

**ABSOLUTE MAXIMUM RATING** ( $T_A = 25^\circ\text{C}$  Unless Otherwise Specified)

DC forward current ( $I_f$ )	40 mA
Operating temperature range	-40°C to +85°C
Storage temperature range	-40°C to +100°C
Lead soldering time (at $\frac{1}{16}$ inch from bottom of lamp)	5 seconds @ 260°C
Peak forward current (at $f=1.0$ KHz, Duty factor=1/10)	200 mA
Power dissipation ( $P_d$ )	110 mW
Recommended operating current ( $I_f$ , Rec)	20 mA



## SUPER BRIGHT T-1 3/4 (5 MM) LED LAMPS

ELECTRO-OPTICAL CHARACTERISTICS ( $T_A = 25^\circ\text{C}$ Unless Otherwise Specified)					
PARAMETER	MIN.	TYP.	MAX.	UNITS	TEST CONDITIONS
Luminous intensity					
MV8102	250	370		mcd	$I_F = 20\text{ mA}$
MV8103	630	940		mcd	$I_F = 20\text{ mA}$
MV8104	1000	1500		mcd	$I_F = 20\text{ mA}$
Forward voltage	1.5	1.7	2.4	V	$I_F = 20\text{ mA}$
Peak wavelength		660		nm	$I_F = 20\text{ mA}$
Spectral line half width		40		nm	$I_F = 20\text{ mA}$
Reverse breakdown voltage		5		V	$I_R = 10\ \mu\text{A}$
Viewing angle		20		degree	$I_F = 20\text{ mA}$

### TYPICAL ELECTRO-OPTICAL CHARACTERISTIC CURVES ( $T_A = 25^\circ\text{C}$ )

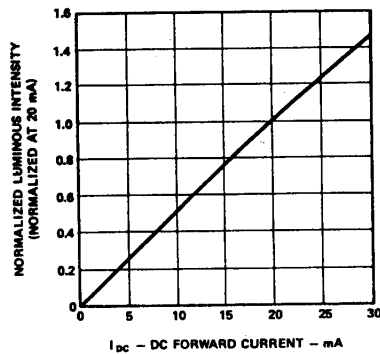

Fig. 1. Relative Luminous Intensity vs. DC Forward Current ST1002

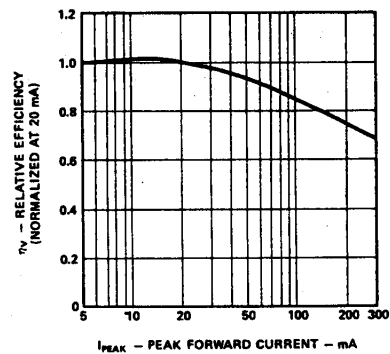

Fig. 2. Relative Efficiency vs. Peak Forward Current ST1761

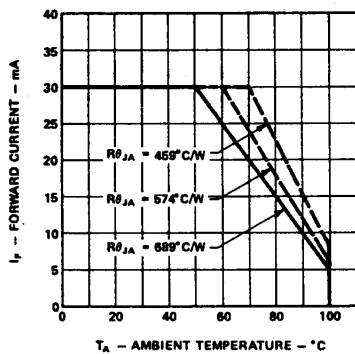

Fig. 3. Maximum Forward DC Current vs. Ambient Temperature Derating Based On  $T_{JMAX} = 110^\circ$  ST1762

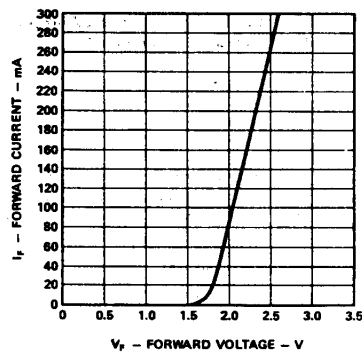

Fig. 4. Forward Current vs. Forward Voltage ST1763

**TYPICAL ELECTRO-OPTICAL CHARACTERISTIC CURVES ( $T_A=25^\circ\text{C}$ )**

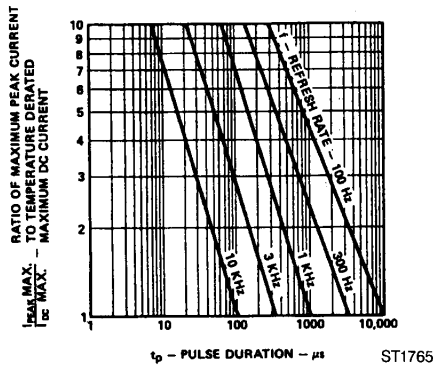

Fig. 5. Maximum Peak Current vs. Pulse Duration

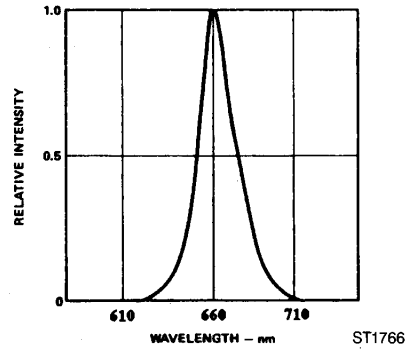

Fig. 6. Relative Intensity vs. Wavelength

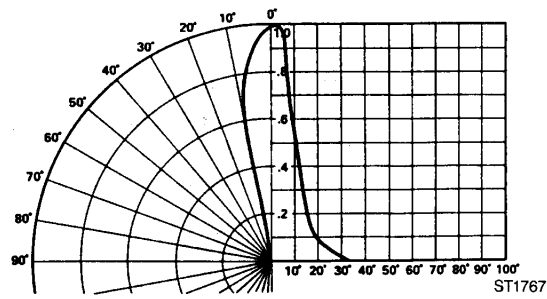

Fig. 7. Relative Luminous Intensity vs. Angular Displacement