

Intelligent Power Module (R-Series)

Maximum Ratings and Characteristics

Absolute Maximum Ratings (T_c=25°C)

Items	Symbols	Ratings		Units
		Min.	Max.	
DC Bus Voltage	V _{DC}	0	900	V
DC Bus Voltage (surge)	V _{DC(Surge)}	0	1000	
DC Bus Voltage (short operating)	V _{SC}	200	800	
Collector-Emitter Voltage	V _{CES}	0	1200	
Inverter Collector Current	Continuous	I _C	50	A
	1ms	I _{CP}	100	
	Duty=62.6%	-I _C	50	
Collector Power Dissipation <small>One Transistor</small>	P _C		400	W
Dynamic Brake	Continuous	I _C	25	A
Collector Current	1ms	I _{CP}	50	
Forward Current of Diode	I _F		25	
Collector Power Dissi. DB <small>One Transistor</small>	P _C		198	W
Voltage of Power Supply for Driver	V _{CC}	0	20	V
Input Signal Voltage	V _{IN}	0	V _Z	V
Input Signal Current	I _{IN}		1	mA
Alarm Signal Voltage	V _{ALM}	0	V _{CC}	V
Alarm Signal Current	I _{ALM}		15	mA
Junction Temperature	T _J		150	°C
Operating Temperature	T _{OP}	-20	100	
Storage Temperature	T _{stg}	-40	125	
Isolation Voltage	A.C. 1min.	V _{iso}	2500	V
Screw Torque	Mounting *1		3.5	Nm
	Terminals *1		3.5	

Note: *1: Recommendable Value; 2.5 - 3.0 Nm (M5)

Outline Drawing

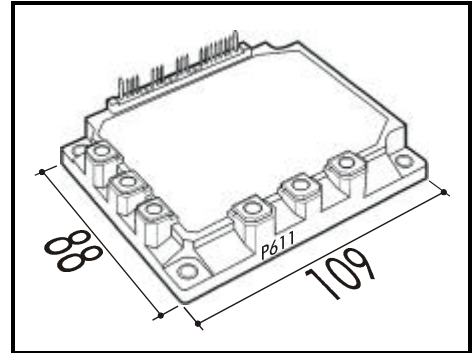

Electrical Characteristics of Power Circuit (at T_J=25°C, V_{CC}=15V)

Items		Symbols	Conditions	Min.	Typ.	Max.	Units
INV	Collector Current At Off Signal Input	I _{CES}	V _{CE} =1200V, Input Terminal Open			1.0	mA
	Collector-Emitter Saturation Voltage	V _{CE(Sat)}	I _C =50A			2.6	V
	Forward Voltage of FWD	V _F	-I _C =50A			3.0	V
DB	Collector Current At Off Signal Input	I _{CES}	V _{CE} =1200V, Input Terminal Open			1.0	mA
	Collector-Emitter Saturation Voltage	V _{CE(Sat)}	I _C =25A			2.6	V
	Forward Voltage of FWD	V _F	-I _C =25A			3.3	V

Electrical Characteristics of Control Circuit (at T_J=25°C, V_{CC}=15V)

Items		Symbols	Conditions	Min.	Typ.	Max.	Units
Current of P-Line Side Driver (One Unit)		I _{CCP}	f _{sw} =0~15kHz, T _C =-20~100°C	3		18	mA
Current of N-Line Side Driver (Three Units)		I _{CCN}	f _{sw} =0~15kHz, T _C =-20~100°C	10		65	
Input Signal Threshold Voltage		V _{IN(th)}	On	1.00	1.35	1.70	V
			Off	1.25	1.60	1.95	
Input Zener Voltage		V _Z	R _{IN} =20kΩ		8.0		
Over Heating Protection Temperature Level		T _{COH}	V _{DC} =0V, I _C =0A, Case Temp.	110		125	°C
Hysteresis		T _{CH}			20		
IGBT Chips Over Heating Protec. Temp. Level		T _{JOH}	Surface Of IGBT Chip	150			
Hysteresis		T _{JH}			20		
Inverter Collector Current Protection Level		I _{OC}	T _J =125°C	75			A
DB Collector Current Protection Level		I _{OC}	T _J =125°C	38			
Over Current Detecting Time		t _{DOC}	T _J =25°C		10		μs
Alarm Signal Hold Time		t _{ALM}		1.5	2		ms
Limiting Resistor for Alarm		R _{ALM}		1425	1500	1575	Ω
Under Voltage Protection Level		V _{UV}		11.0		12.5	V
Hysteresis		V _H		0.2			

Dynamic Characteristics (at T_C=T_J=125°C, V_{CC}=15V)

Items	Symbols	Conditions	Min.	Typ.	Max.	Units
Switching Time	t _{ON}	I _C =50A, V _{DC} =600V	0.3			μs
	t _{OFF}				3.6	
	t _{RR}	I _F =50A, V _{DC} =600V			0.4	

• **Thermal Characteristics**

Items	Symbols	Conditions	Min.	Typ.	Max.	Units
Thermal Resistance	$R_{th(i-e)}$	Inverter IGBT			0.31	°C/W
	$R_{th(i-c)}$	Diode			0.70	
	$R_{th(i-c)}$	DB IGBT			0.63	
	$R_{th(c-f)}$	With Thermal Compound		0.05		

■ **Equivalent Circuit**

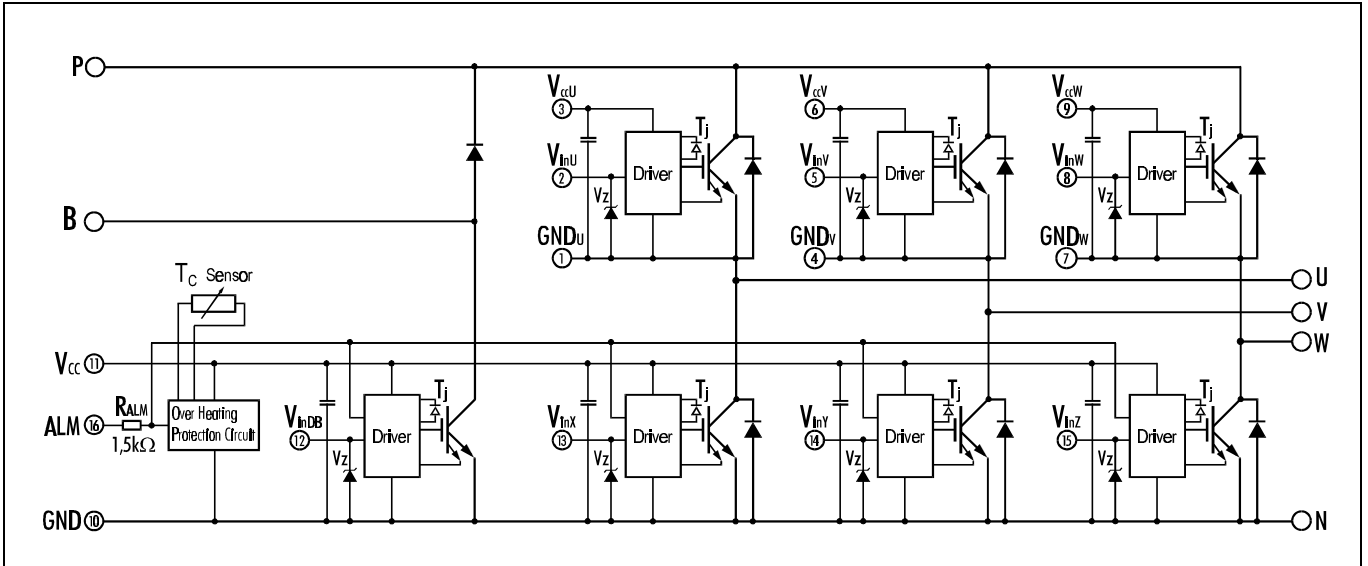

Drivers include following functions

- Short circuit protection circuit
- Amplifier for driver
- Undervoltage protection circuit
- Overcurrent protection circuit
- IGBT Chip overheating protection

Dynamic Brake

Collector Current vs. Collector-Emitter Voltage

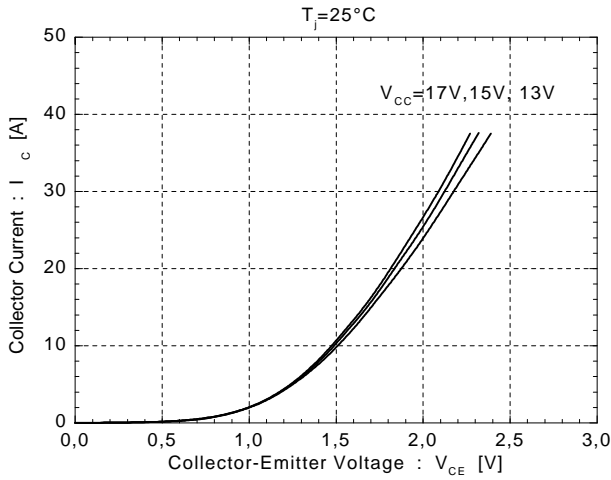

Collector Current vs. Collector-Emitter Voltage

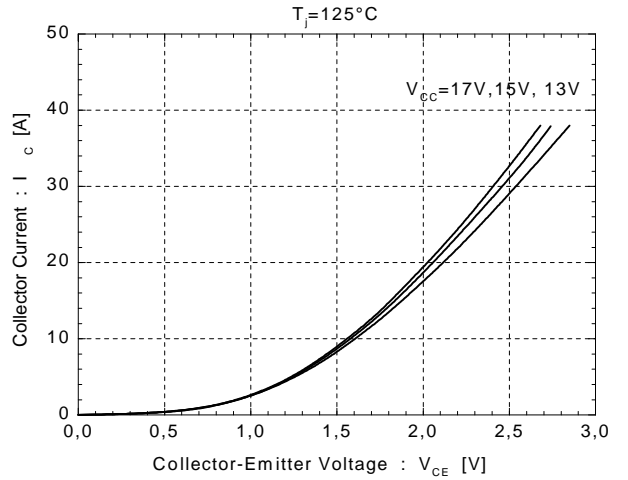

Transient Thermal Resistance

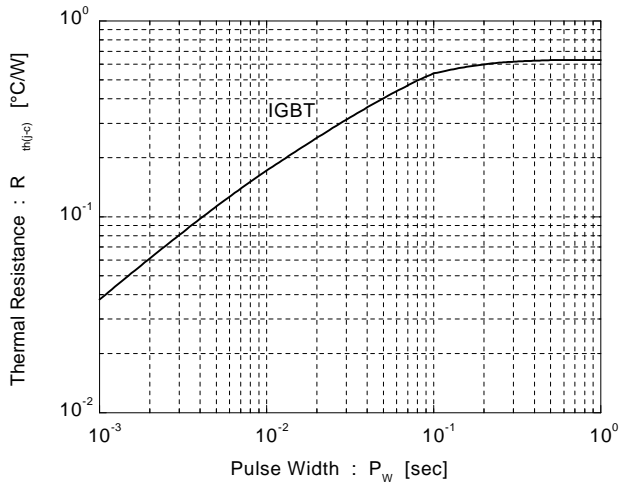

Reverse Biased Safe Operating Area

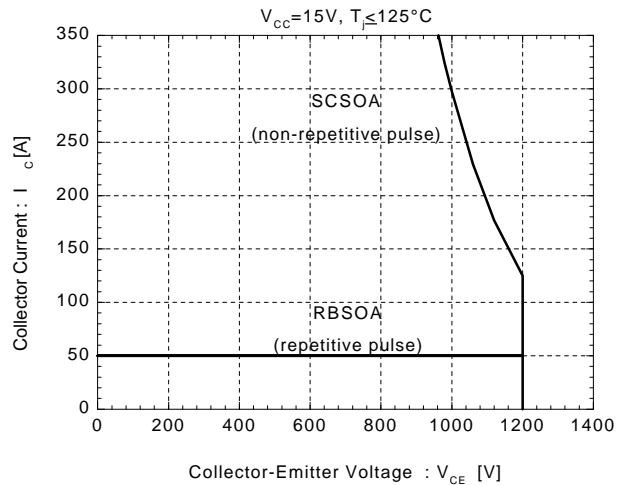

Power Derating For IGBT
(per device)

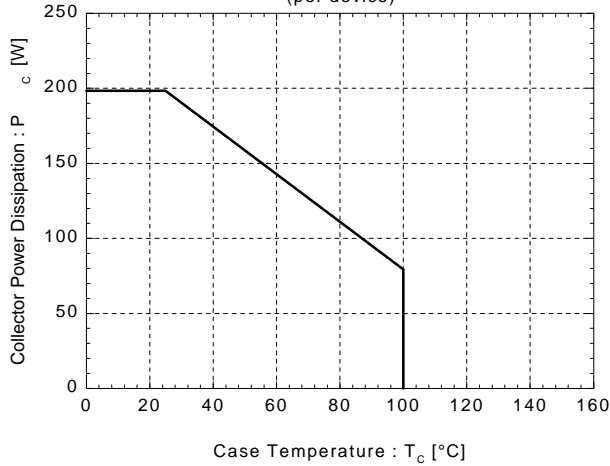

Over Current Protection vs. Junction Temperature

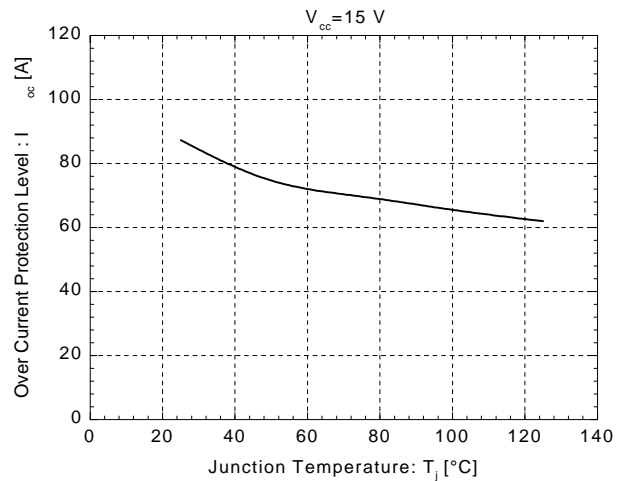

Control Circuit

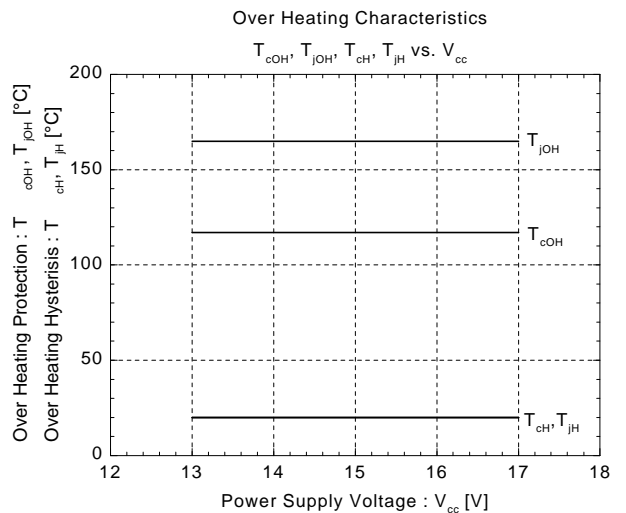
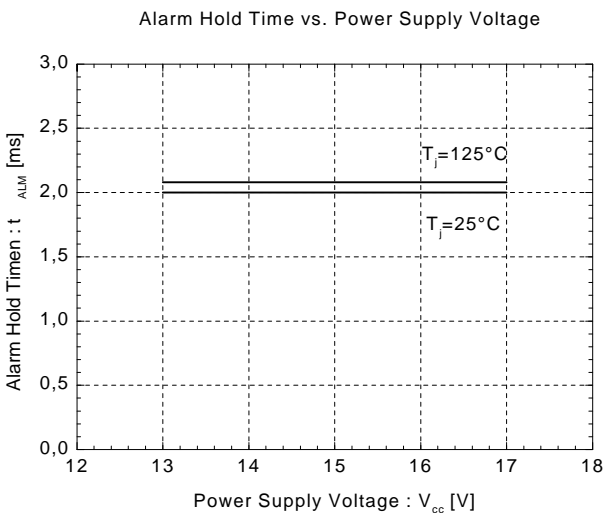
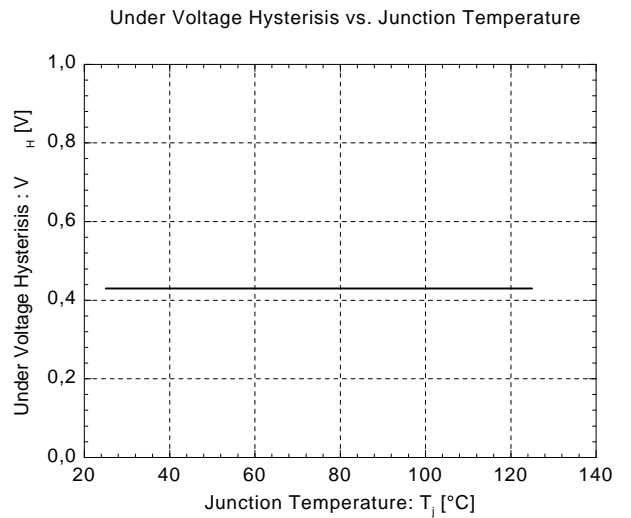
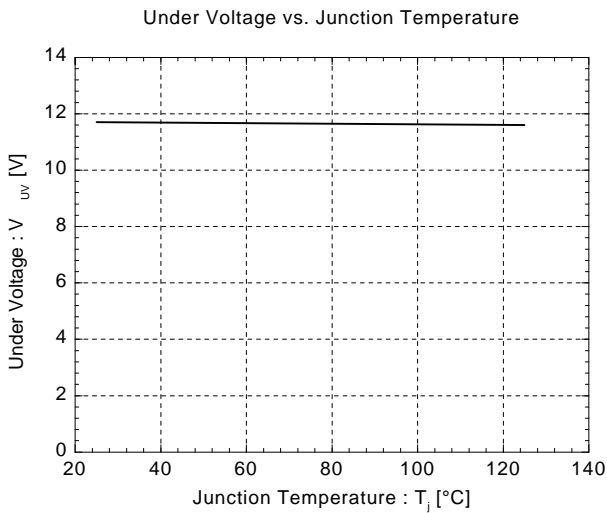
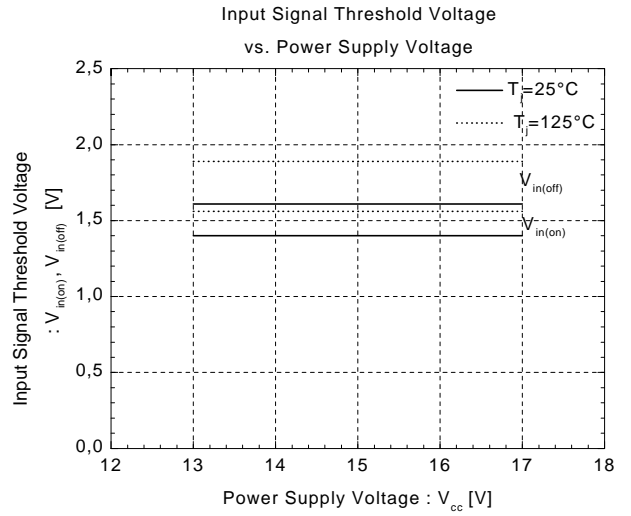
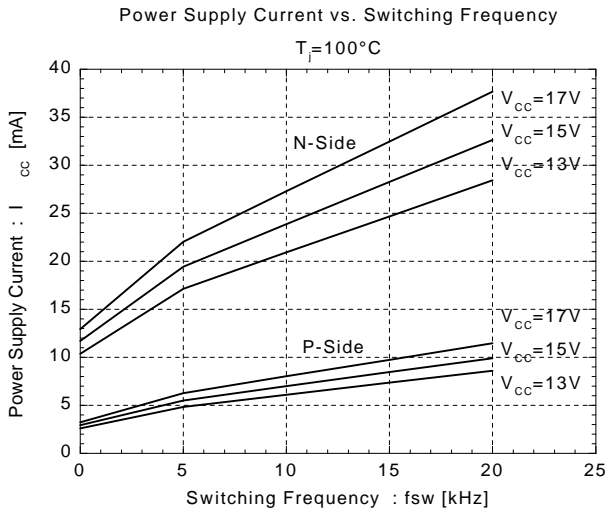

■ Inverter

Collector Current vs. Collector-Emitter Voltage

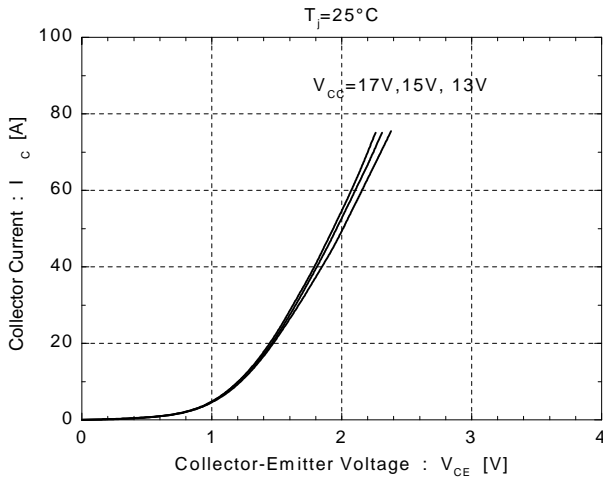

Collector Current vs. Collector-Emitter Voltage

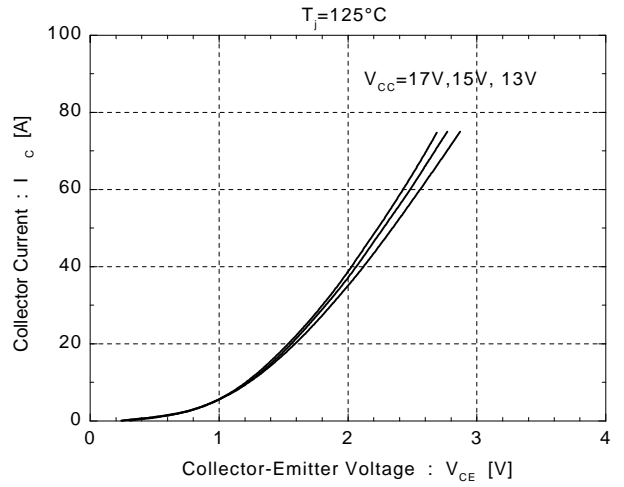

Switching Time vs. Collector Current

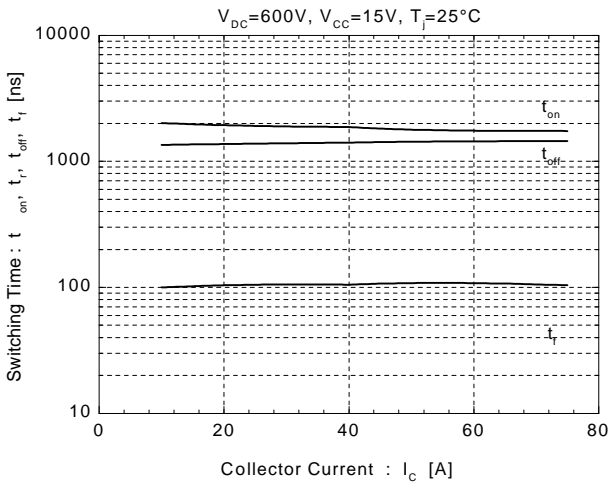

Switching Time vs. Collector Current

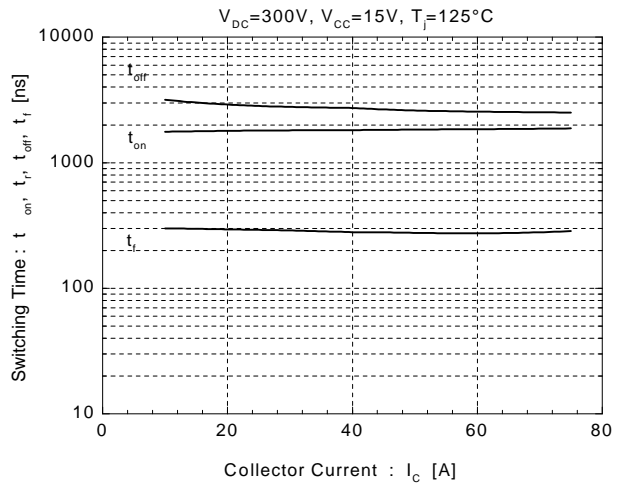

Forward Voltage vs. Forward Current

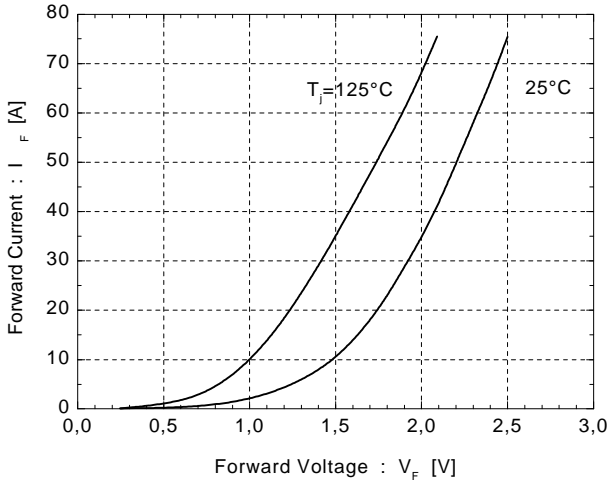

Reverse Recovery Characteristics

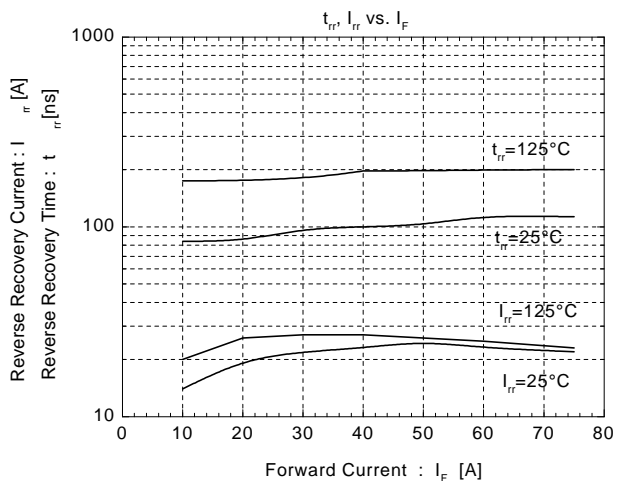

■ Inverter

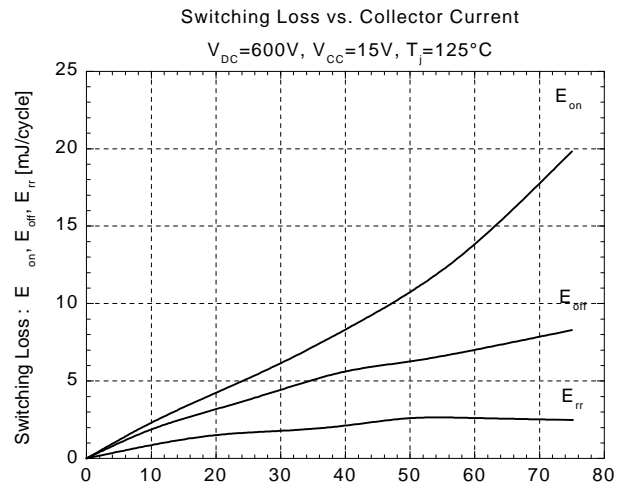
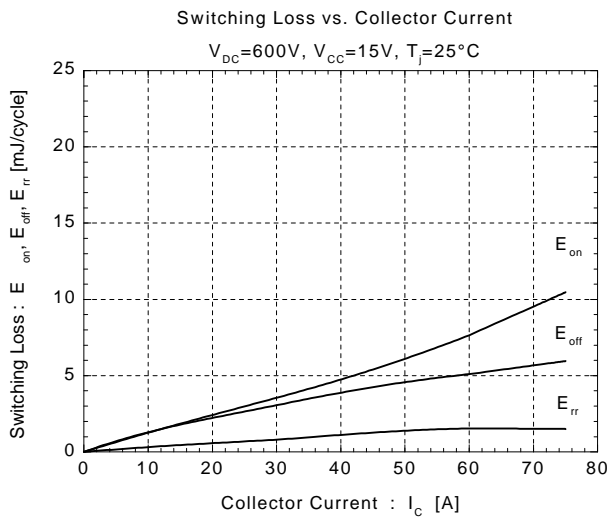
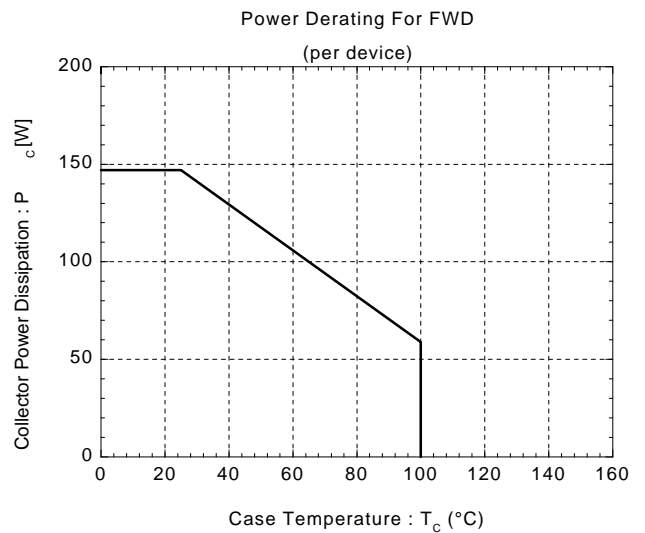
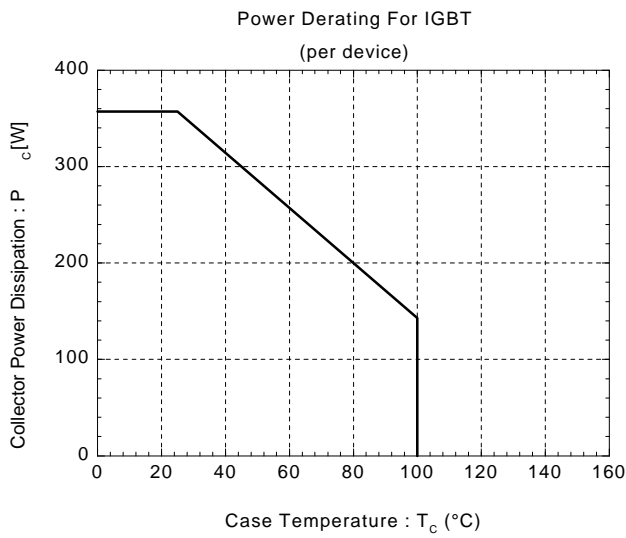
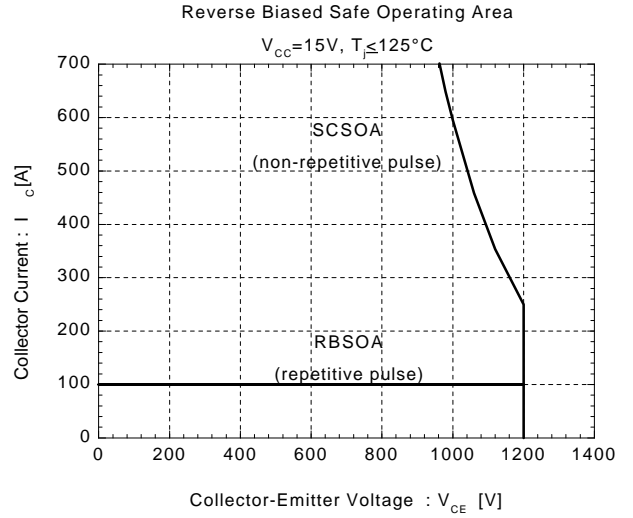
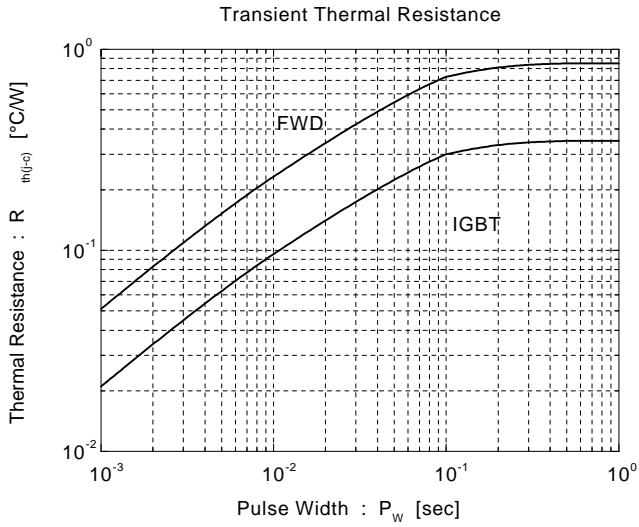

■ Inverter

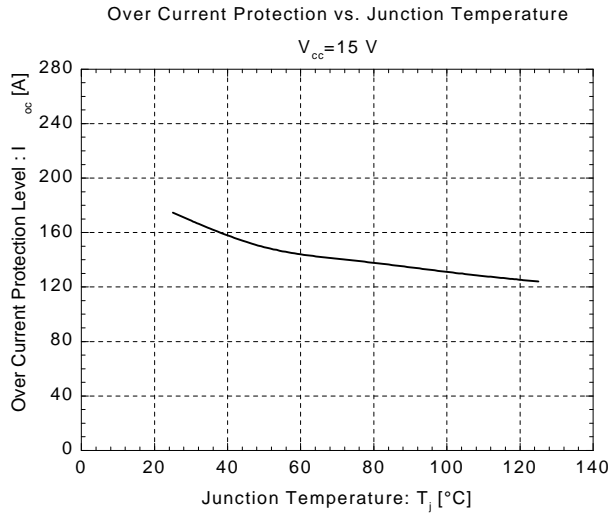

■ Outline Drawing

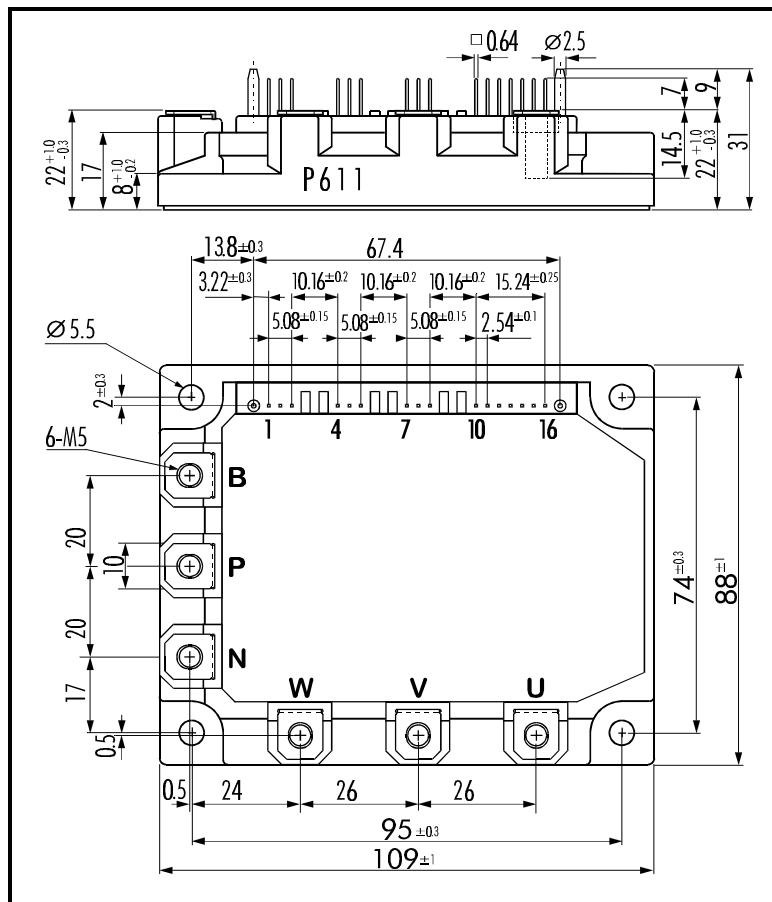

Weight: 440g