

**2SA1599**  
**(TP10T4)**

**-10A PNP**

### OUTLINE DIMENSIONS

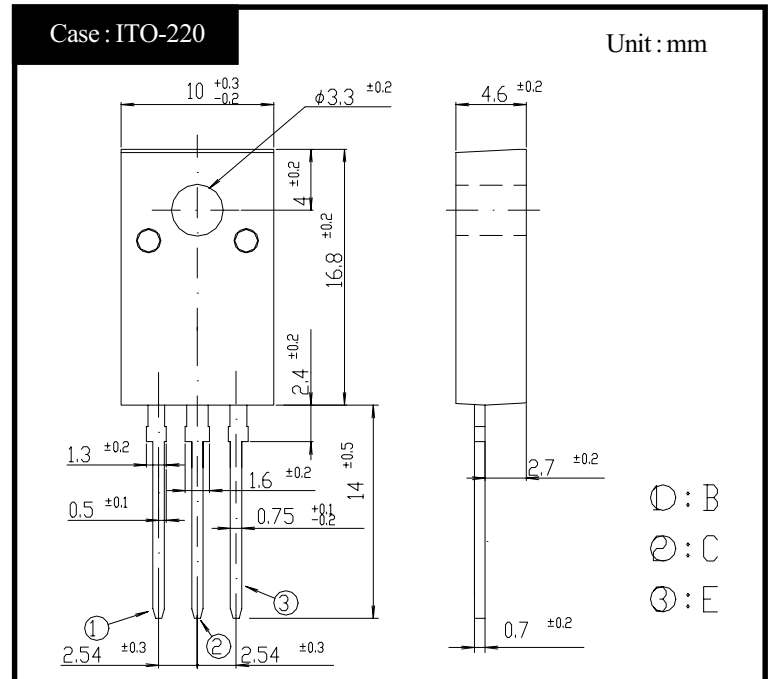

### RATINGS

#### ● Absolute Maximum Ratings

Item	Symbol	Conditions	Ratings	Unit
Storage Temperature	$T_{stg}$		-55~150	°C
Junction Temperature	$T_j$		150	°C
Collector to Base Voltage	$V_{CBO}$		-60	V
Collector to Emitter Voltage	$V_{CEO}$		-40	V
Emitter to Base Voltage	$V_{EBO}$		-7	V
Collector Current DC	$I_C$		-10	A
Collector Current Peak	$I_{CP}$		-20	A
Base Current DC	$I_B$		-1.5	A
Base Current Peak	$I_{BP}$		-2	A
Total Transistor Dissipation	$P_T$	$T_c = 25^\circ\text{C}$	25	W
Dielectric Strength	$V_{dis}$	Terminal to case, AC 1 minute	2	kV
Mounting Torque	TOR	(Recommended torque : 0.3N·m)	0.5	N·m

#### ● Electrical Characteristics ( $T_c=25^\circ\text{C}$ )

Item	Symbol	Conditions	Ratings	Unit
Collector to Emitter Sustaining Voltage	$V_{CEO(sus)}$	$I_C = -0.1\text{A}$	Min -40	V
Collector Cutoff Current	$I_{CBO}$	At rated Voltage	Max -0.1	mA
			Max -0.1	
Emitter Cutoff Current	$I_{EBO}$	At rated Voltage	Max -0.1	mA
DC Current Gain	$h_{FE}$	$V_{CE} = -2\text{V}, I_C = -5\text{A}$	Min 70	
Collector to Emitter Saturation Voltage	$V_{CE(sat)}$	$I_C = -5\text{A}$	Max -0.3	V
Base to Emitter Saturation Voltage	$V_{BE(sat)}$	$I_B = -0.25\text{A}$	Max -1.2	V
Thermal Resistance	$\theta_{jc}$	Junction to case	Max 5	°C/W
Transition Frequency	$f_T$	$V_{CE} = -10\text{V}, I_C = -1\text{A}$	TYP 50	MHz
Turn on Time	$t_{on}$	$I_C = -5\text{A}$ $I_{B1} = -0.5\text{A}, I_{B2} = -0.5\text{A}$ $R_L = 5\Omega, V_{BB2} = -4\text{V}$	Max 0.3	$\mu\text{s}$
Storage Time	$t_s$		Max 1.5	
Fall Time	$t_f$		Max 0.5	

# 2SA1599

$h_{FE} - I_C$

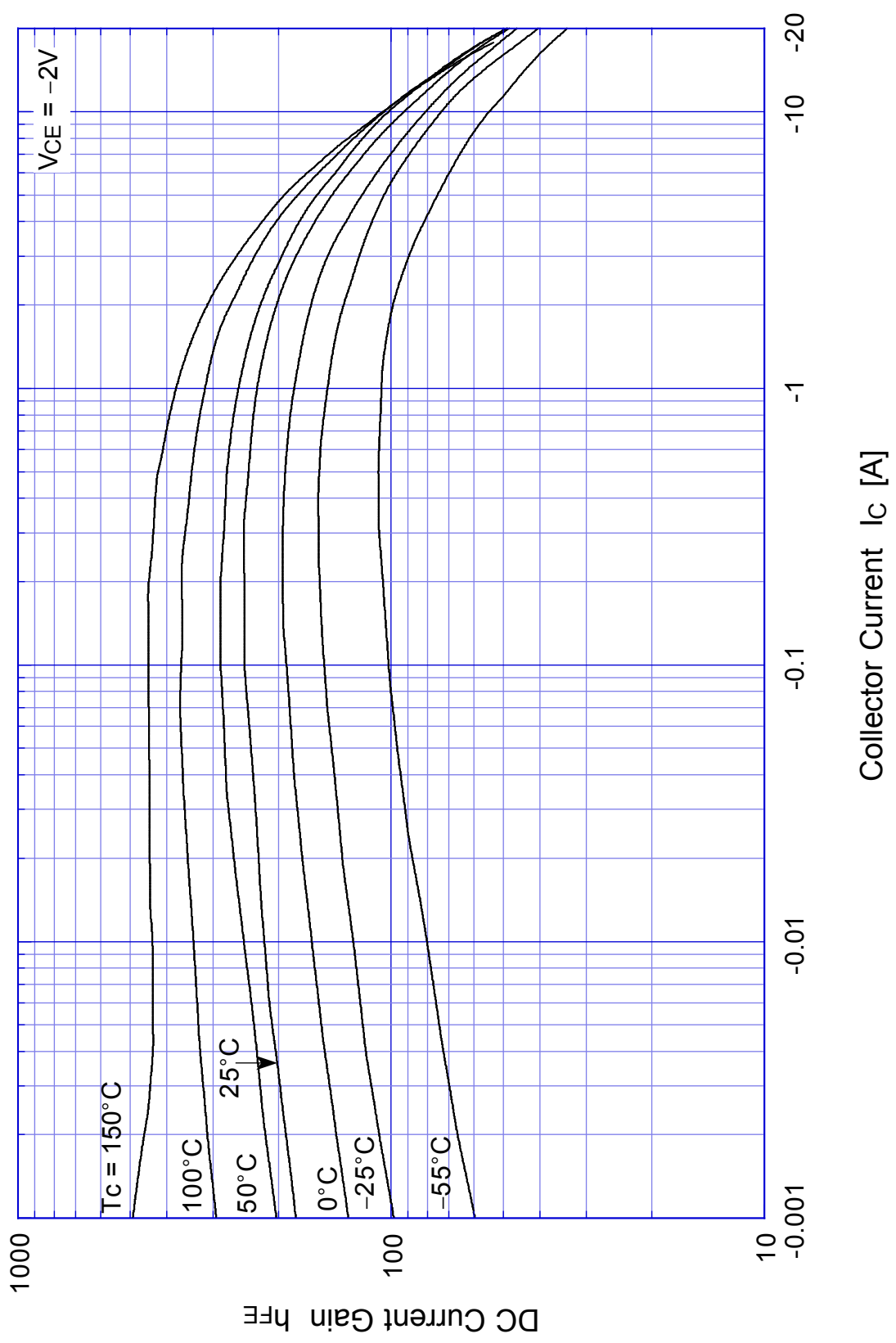

# 2SA1599 Saturation Voltage

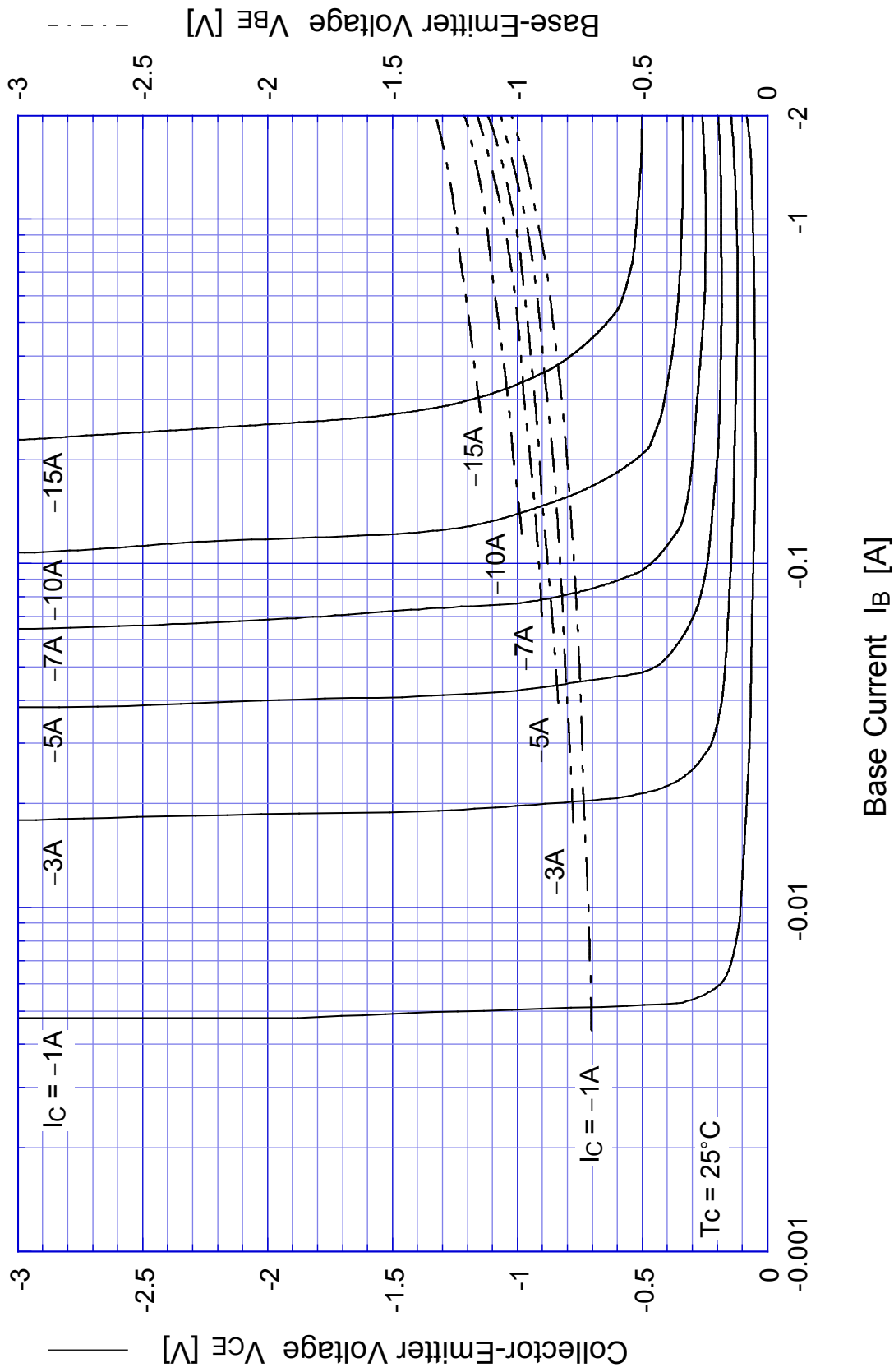

# 2SA1599

## Switching Time - $I_C$

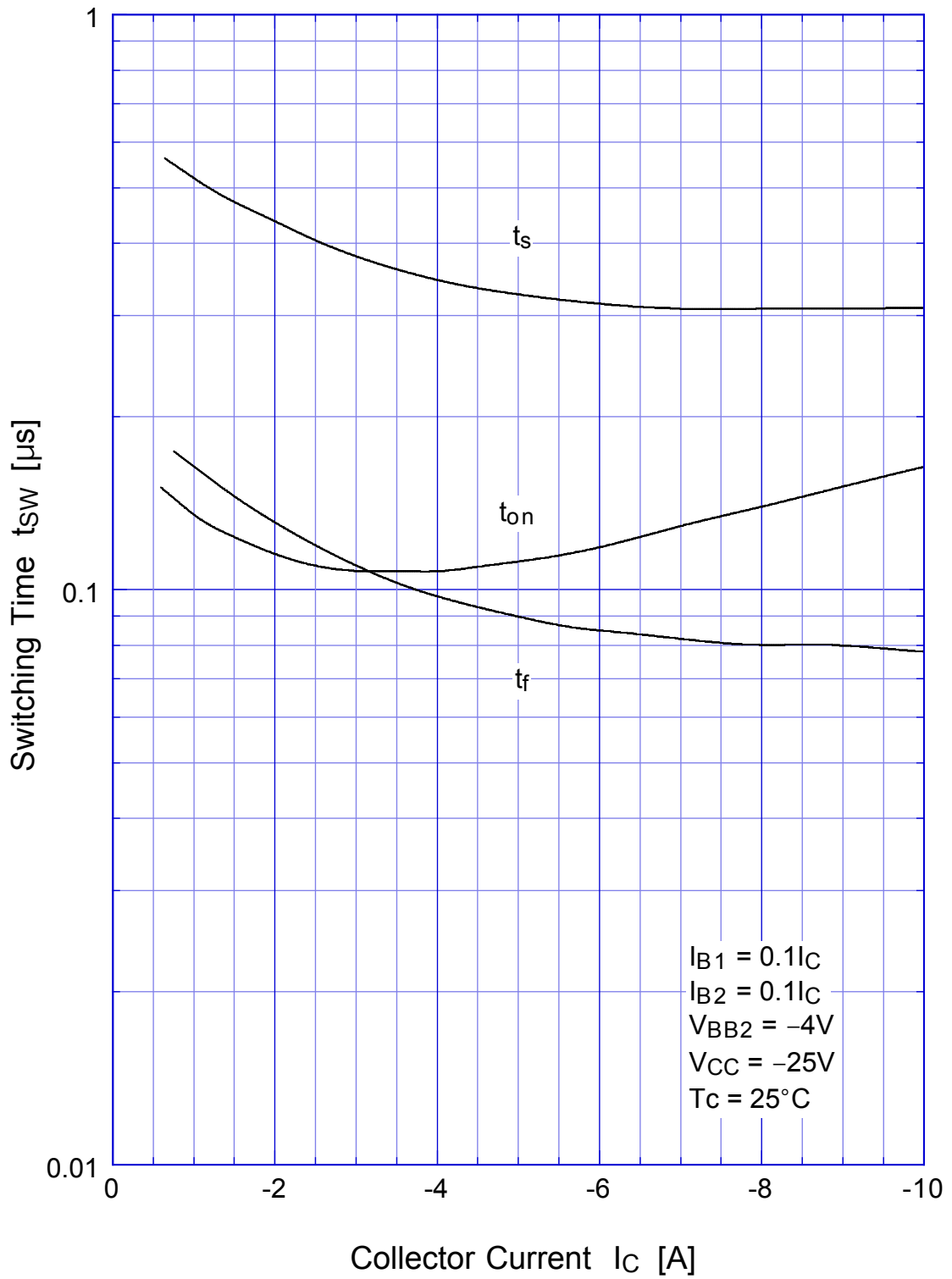

# 2SA1599

## Switching Time - Tc

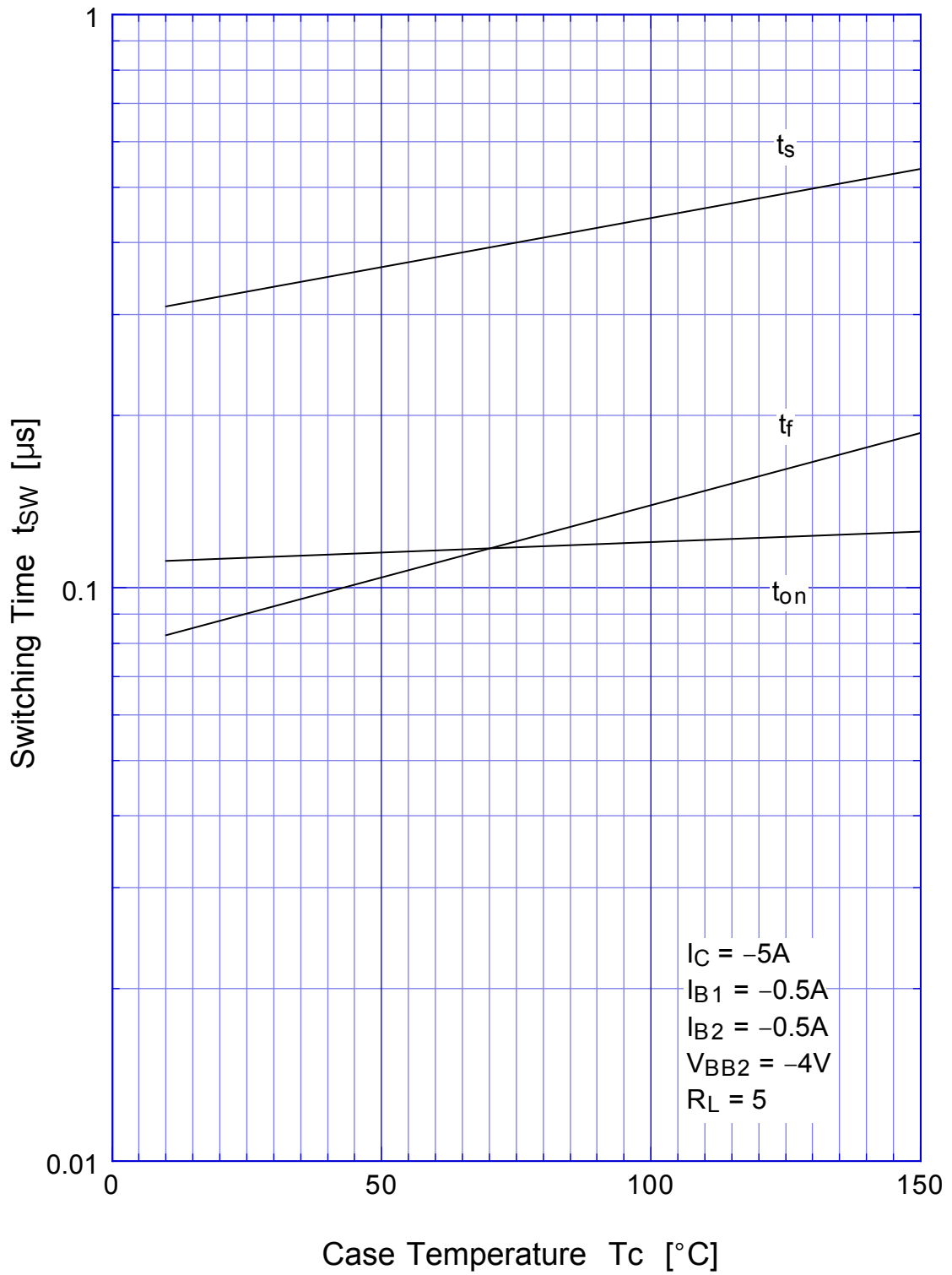

# 2SA1599 Transient Thermal Impedance

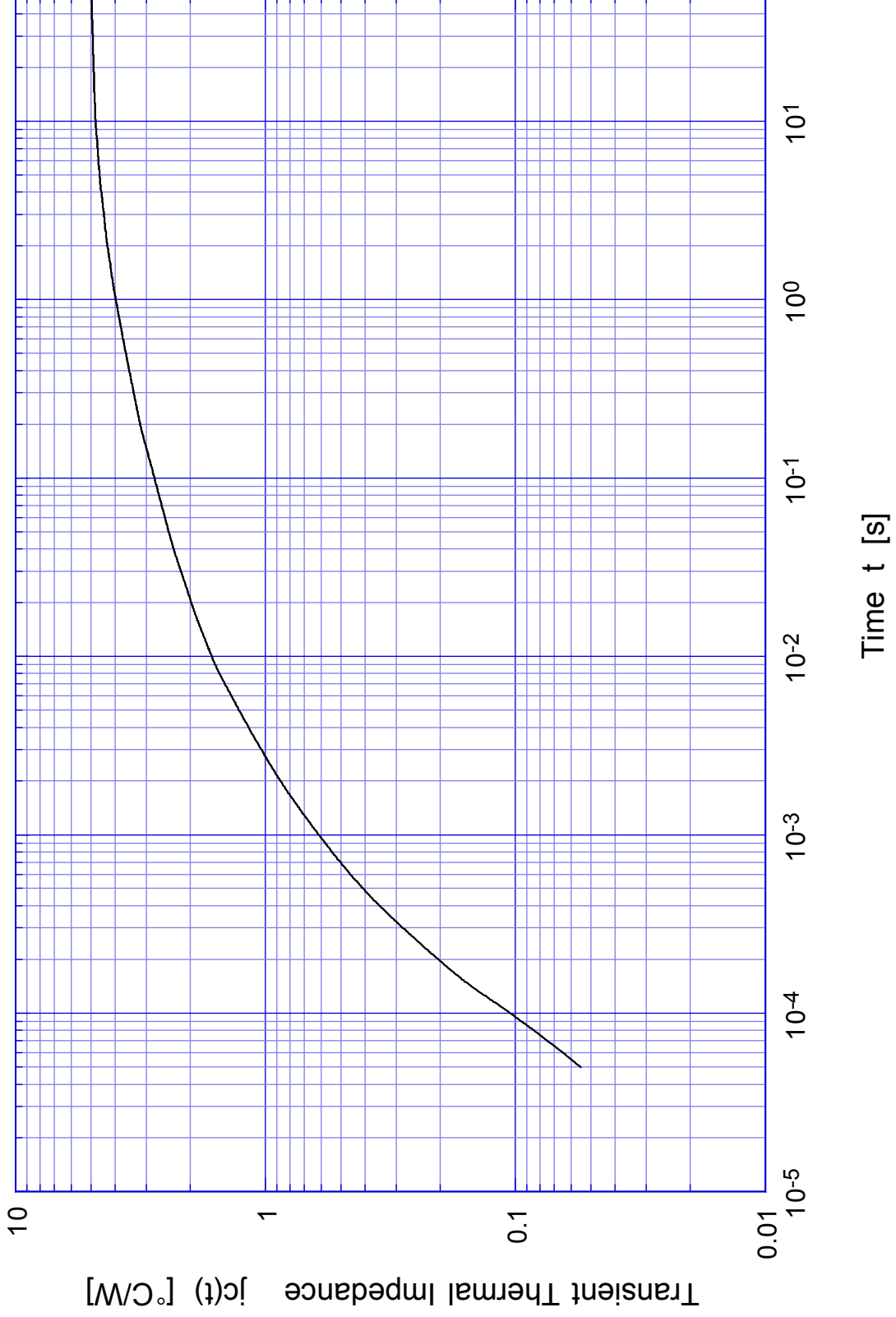

# 2SA1599

# Forward Bias SOA

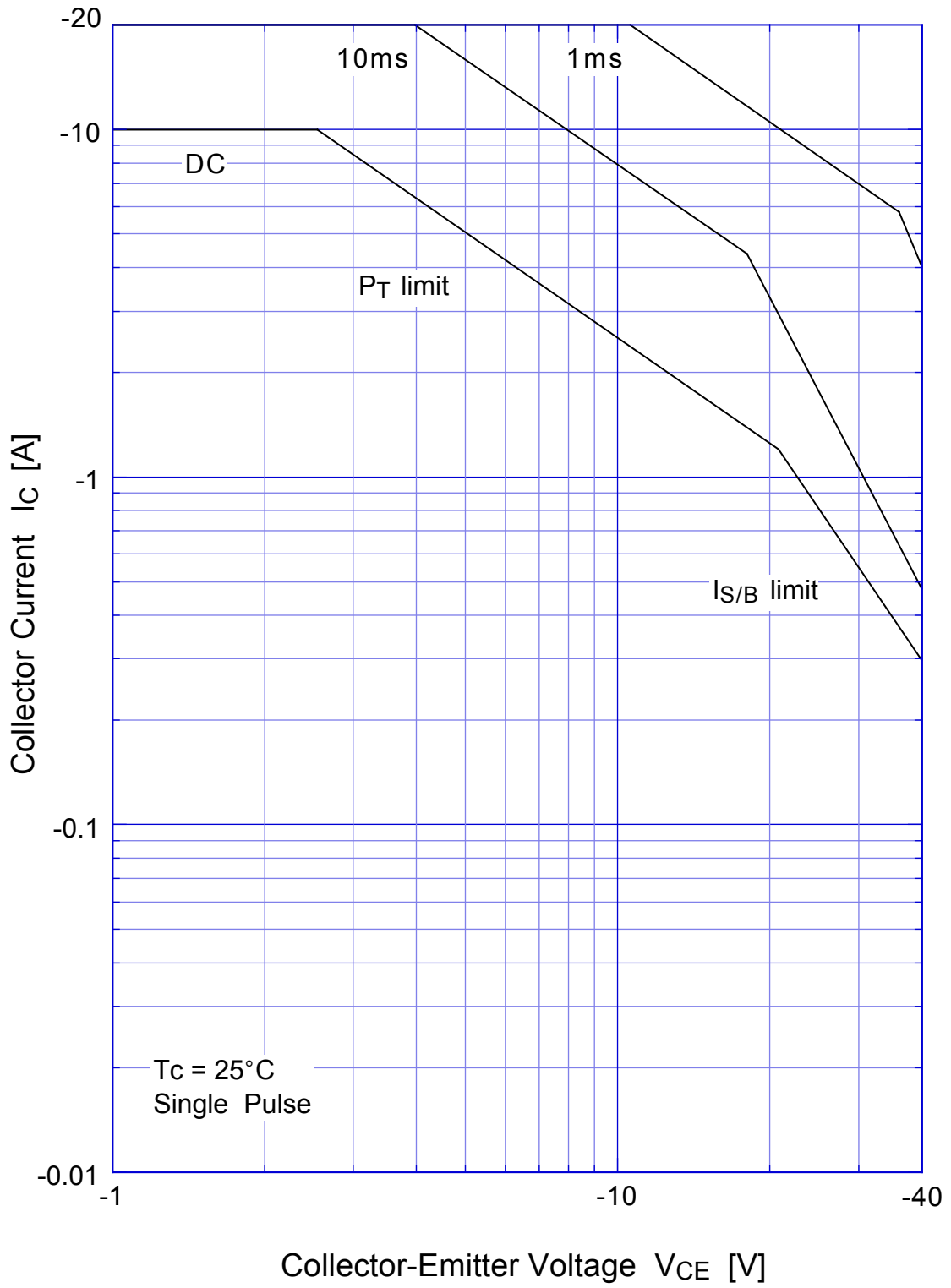

## 2SA1599 Collector Current Derating

