

512K x 8 Bit Static Random Access Memory

The MCM6246 is a 4,194,304 bit static random access memory organized as 524,288 words of 8 bits. Static design eliminates the need for external clocks or timing strobes, while CMOS circuitry reduces power consumption and provides for greater reliability.

The MCM6246 is equipped with chip enable (\bar{E}) and output enable (\bar{G}) pins, allowing for greater system flexibility and eliminating bus contention problems. Either input, when high, will force the outputs into high impedance.

The MCM6246 is available in a 400 mil, 36-lead surface-mount SOJ package.

- Single 5 V \pm 10% Power Supply
- Fast Access Time: 17/20/25/35 ns
- Equal Address and Chip Enable Access Time
- All Inputs and Outputs are TTL Compatible
- Three-State Outputs
- Power Operation: 205/200/185/170 mA Maximum, Active AC

BLOCK DIAGRAM

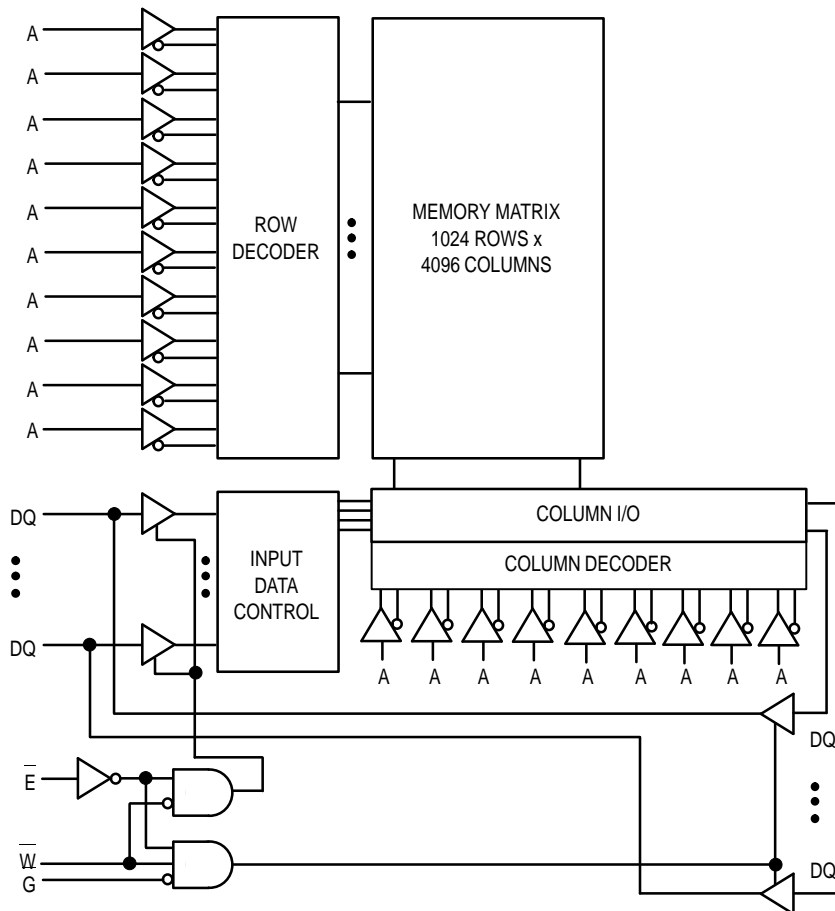

MCM6246

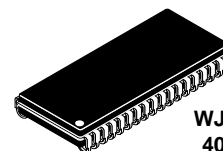

WJ PACKAGE
400 MIL SOJ
CASE 893-01

PIN ASSIGNMENT

A	1	36	NC
A	2	35	A
A	3	34	A
A	4	33	A
A	5	32	A
\bar{E}	6	31	\bar{G}
DQ	7	30	DQ
DQ	8	29	DQ
VCC	9	28	VSS
VSS	10	27	VCC
DQ	11	26	DQ
DQ	12	25	DQ
\bar{W}	13	24	A
A	14	23	A
A	15	22	A
A	16	21	A
A	17	20	A
A	18	19	NC

PIN NAMES

A	Address Inputs
\bar{W}	Write Enable
\bar{G}	Output Enable
\bar{E}	Chip Enable
DQ	Data Input/Output
NC	No Connection
VCC	+ 5 V Power Supply
VSS	Ground

TRUTH TABLE (X = Don't Care)

E	G	W	Mode	I/O Pin	Cycle	Current
H	X	X	Not Selected	High-Z	—	I _{SB1} , I _{SB2}
L	H	H	Output Disabled	High-Z	—	I _{CCA}
L	L	H	Read	D _{out}	Read	I _{CCA}
L	X	L	Write	High-Z	Write	I _{CCA}

ABSOLUTE MAXIMUM RATINGS (See Note)

Rating	Symbol	Value	Unit
Power Supply Voltage Relative to V _{SS}	V _{CC}	- 0.5 to + 7.0	V
Voltage Relative to V _{SS} for Any Pin Except V _{CC}	V _{in} , V _{out}	- 0.5 to V _{CC} + 0.5	V
Output Current (per I/O)	I _{out}	± 20	mA
Power Dissipation	P _D	1.0	W
Temperature Under Bias	T _{bias}	- 10 to + 85	°C
Ambient Temperature	T _A	0 to + 70	°C
Storage Temperature — Plastic	T _{stg}	- 55 to + 150	°C

NOTE: Permanent device damage may occur if ABSOLUTE MAXIMUM RATINGS are exceeded. Functional operation should be restricted to RECOMMENDED OPERATING CONDITIONS. Exposure to higher than recommended voltages for extended periods of time could affect device reliability.

This device contains circuitry to protect the inputs against damage due to high static voltages or electric fields; however, it is advised that normal precautions be taken to avoid application of any voltage higher than maximum rated voltages to these high impedance circuits.

This CMOS memory circuit has been designed to meet the dc and ac specifications shown in the tables, after thermal equilibrium has been established. The circuit is in a test socket or mounted on a printed circuit board and transverse air flow of at least 500 linear feet per minute is maintained.

DC OPERATING CONDITIONS AND CHARACTERISTICS

(V_{CC} = 5.0 V ± 10%, T_A = 0 to + 70°C, Unless Otherwise Noted)

RECOMMENDED OPERATING CONDITIONS

Parameter	Symbol	Min	Typ	Max	Unit
Supply Voltage (Operating Voltage Range)	V _{CC}	4.5	5.0	5.5	V
Input High Voltage	V _{IH}	2.2	—	V _{CC} + 0.3**	V
Input Low Voltage	V _{IL}	- 0.5*	—	0.8	V

* V_{IL} (min) = - 0.5 V dc; V_{IL} (min) = - 2.0 V ac (pulse width ≤ 2.0 ns).

** V_{IH} (max) = V_{CC} + 0.3 V dc; V_{IH} (max) = V_{CC} + 2.0 V ac (pulse width ≤ 2.0 ns).

DC CHARACTERISTICS

Parameter	Symbol	Min	Max	Unit
Input Leakage Current (All Inputs, V _{in} = 0 to V _{CC})	I _{lkg(I)}	—	± 1.0	µA
Output Leakage Current (E = V _{IH} , V _{out} = 0 to V _{CC})	I _{lkg(O)}	—	± 1.0	µA
Output Low Voltage (I _{OL} = + 8.0 mA)	V _{OL}	—	0.4	V
Output High Voltage (I _{OH} = - 4.0 mA)	V _{OH}	2.4	—	V

POWER SUPPLY CURRENTS

Parameter	Symbol	Min	Typ	Max	Unit
AC Active Supply Current (I _{out} = 0 mA, V _{CC} = max) MCM6246-17: t _{AVAV} = 17 ns MCM6246-20: t _{AVAV} = 20 ns MCM6246-25: t _{AVAV} = 25 ns MCM6246-35: t _{AVAV} = 35 ns	I _{CC}	—	— 185 170 155	205 200 185 170	mA
AC Standby Current (V _{CC} = max, E = V _{IH} , No other restrictions on other inputs) MCM6246-17: t _{AVAV} = 17 ns MCM6246-20: t _{AVAV} = 20 ns MCM6246-25: t _{AVAV} = 25 ns MCM6246-35: t _{AVAV} = 35 ns	I _{SB1}	—	55 55 45 35	60 60 50 40	mA
CMOS Standby Current (E ≥ V _{CC} - 0.2 V, V _{in} ≤ V _{SS} + 0.2 V or ≥ V _{CC} - 0.2 V) (V _{CC} = max, f = 0 MHz)	I _{SB2}	—	10	15	mA

CAPACITANCE (f = 1.0 MHz, dV = 3.0 V, T_A = 25°C, Periodically Sampled Rather Than 100% Tested)

Parameter	Symbol	Typ	Max	Unit	
Input Capacitance	All Inputs Except Clocks and DQs	C _{in}	4	6	pF
	E, G, W	C _{ck}	5	8	
Input/Output Capacitance	DQ	C _{I/O}	5	8	pF

AC OPERATING CONDITIONS AND CHARACTERISTICS

(V_{CC} = 5.0 V ± 10%, T_A = 0 to + 70°C, Unless Otherwise Noted)

Input Pulse Levels 0 to 3.0 V Output Timing Measurement Reference Level 1.5 V
 Input Rise/Fall Time 2 ns Output Load See Figure 1
 Input Timing Measurement Reference Level 1.5 V

READ CYCLE TIMING (See Note 1)

Parameter	Symbol	MCM6246-17		MCM6246-20		MCM6246-25		MCM6246-35		Unit	Notes
		Min	Max	Min	Max	Min	Max	Min	Max		
Read Cycle Time	t _{AVAV}	17	—	20	—	25	—	35	—	ns	2, 3
Address Access Time	t _{AVQV}	—	17	—	20	—	25	—	35	ns	
Enable Access Time	t _{ELQV}	—	17	—	20	—	25	—	35	ns	4
Output Enable Access Time	t _{GLQV}	—	6	—	6	—	8	—	10	ns	
Output Hold from Address Change	t _{AXQX}	5	—	5	—	5	—	5	—	ns	
Enable Low to Output Active	t _{ELQX}	5	—	5	—	5	—	5	—	ns	5, 6, 7
Output Enable Low to Output Active	t _{GLQX}	0	—	0	—	0	—	0	—	ns	5, 6, 7
Enable High to Output High-Z	t _{EHQZ}	—	8	—	8	—	10	—	12	ns	5, 6, 7
Output Enable High to Output High-Z	t _{GHQZ}	—	8	—	8	—	10	—	12	ns	5, 6, 7
Power Up Time	t _{ELICCH}	0	—	0	—	0	—	0	—	ns	
Power Down Time	t _{EHICCL}	—	17	—	20	—	25	—	35	ns	

NOTES:

1. W is high for read cycle.
2. Product sensitivities to noise require proper grounding and decoupling of power supplies as well as minimization or elimination of bus contention conditions during read and write cycles.
3. All read cycle timings are referenced from the last valid address to the first transitioning address.
4. Addresses valid prior to or coincident with E going low/E going high.
5. At any given voltage and temperature, t_{EHQZ} max < t_{ELQX} min, and t_{GHQZ} max < t_{GLQX} min, both for a given device and from device to device.
6. Transition is measured ± 500 mV from steady-state voltage.
7. This parameter is sampled and not 100% tested.
8. Device is continuously selected (E ≤ V_{IL}, G ≤ V_{IL}).

TIMING LIMITS

The table of timing values shows either a minimum or a maximum limit for each parameter. Input requirements are specified from the external system point of view. Thus, address setup time is shown as a minimum since the system must supply at least that much time. On the other hand, responses from the memory are specified from the device point of view. Thus, the access time is shown as a maximum since the device never provides data later than that time.

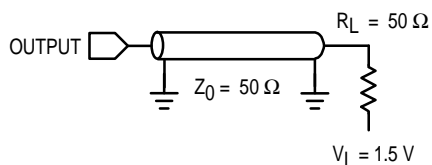
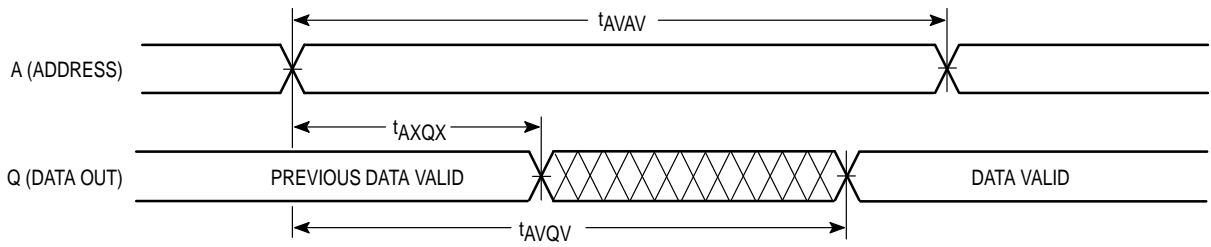
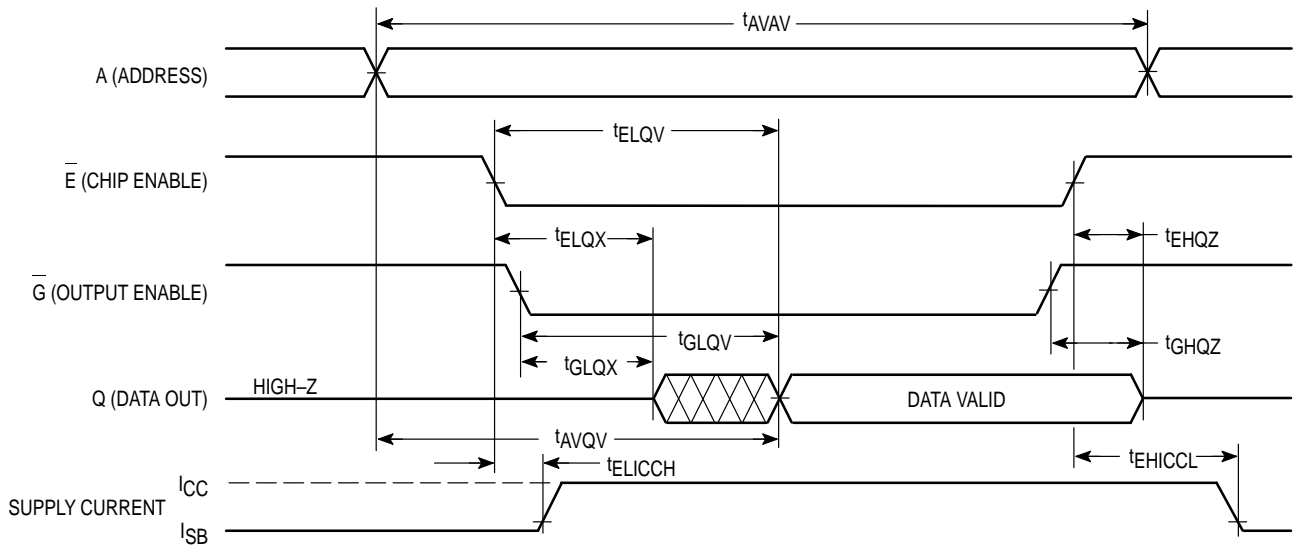

Figure 1. AC Test Load

READ CYCLE 1 (See Note 8)



READ CYCLE 2 (See Note)



NOTE: Addresses valid prior to or coincident with \bar{E} going low/ \bar{E} going high.

WRITE CYCLE 1 (\overline{W} Controlled, See Notes 1, 2, and 3)

Parameter	Symbol	MCM6246-17		MCM6246-20		MCM6246-25		MCM6246-35		Unit	Notes
		Min	Max	Min	Max	Min	Max	Min	Max		
Write Cycle Time	t_{AVAV}	17	—	20	—	25	—	35	—	ns	4
Address Setup Time	t_{AVWL}	0	—	0	—	0	—	0	—	ns	
Address Valid to End of Write	t_{AVWH}	14	—	14	—	17	—	20	—	ns	
Write Pulse Width	t_{WLWH} , t_{WLEH}	13	—	13	—	17	—	20	—	ns	
Data Valid to End of Write	t_{DVWH}	10	—	10	—	10	—	15	—	ns	
Data Hold Time	t_{WHDX}	0	—	0	—	0	—	0	—	ns	
Write Low to Data High-Z	t_{WLQZ}	0	9	0	9	0	10	0	15	ns	5,6,7
Write High to Output Active	t_{WHQX}	5	—	5	—	5	—	5	—	ns	5,6,7
Write Recovery Time	t_{WHAX}	0	—	0	—	0	—	0	—	ns	

NOTES:

1. A write occurs during the overlap of \overline{E} low and \overline{W} low.
2. Product sensitivities to noise require proper grounding and decoupling of power supplies as well as minimization or elimination of bus contention conditions during read and write cycles.
3. If G goes low coincident with or after W goes low, the output will remain in a high-impedance state.
4. All write cycle timings are referenced from the last valid address to the first transitioning address.
5. Transition is measured ± 500 mV from steady-state voltage.
6. This parameter is sampled and not 100% tested.
7. At any given voltage and temperature, $t_{WLQZ} \text{ max} < t_{WHQX} \text{ min}$ both for a given device and from device to device.

WRITE CYCLE 1 (\overline{W} Controlled, See Notes 1, 2, and 3)

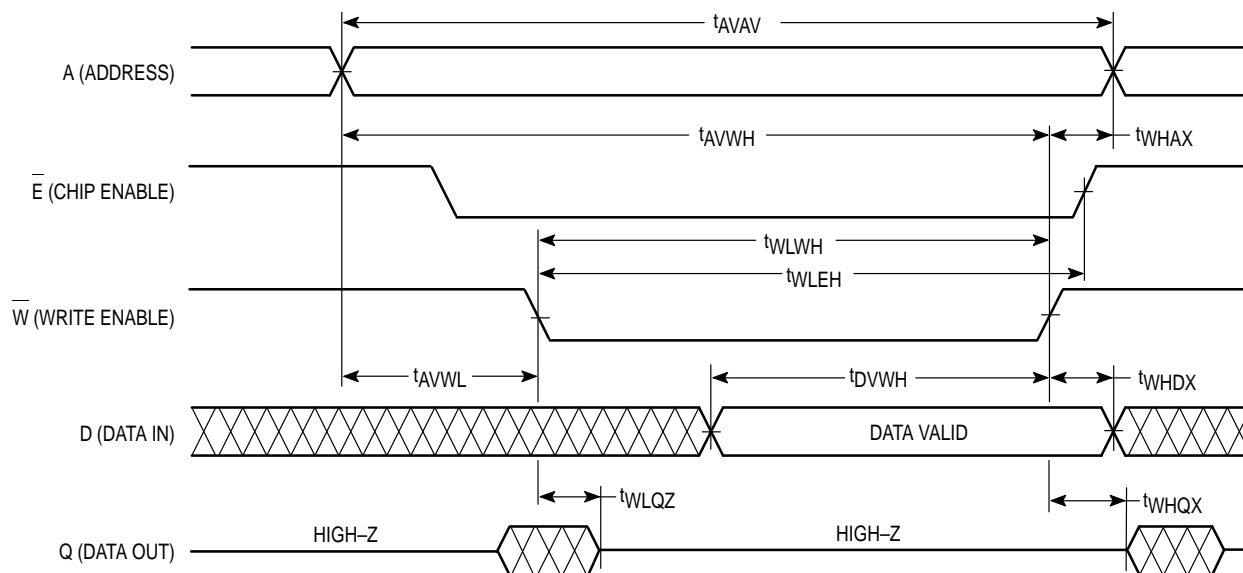

WRITE CYCLE 2 (\bar{E} Controlled, See Notes 1, 2, and 3)

Parameter	Symbol	MCM6246-17		MCM6246-20		MCM6246-25		MCM6246-35		Unit	Notes
		Min	Max	Min	Max	Min	Max	Min	Max		
Write Cycle Time	t_{AVAV}	17	—	20	—	25	—	35	—	ns	4
Address Setup Time	t_{AVEL}	0	—	0	—	0	—	0	—	ns	
Address Valid to End of Write	t_{AVEH}	14	—	14	—	17	—	20	—	ns	
Enable Pulse Width	t_{ELEH} , t_{ELWH}	14	—	14	—	17	—	20	—	ns	5,6
Write Pulse Width	t_{WLEH}	14	—	14	—	17	—	20	—	ns	
Data Valid to End of Write	t_{DVEH}	9	—	10	—	10	—	15	—	ns	
Data Hold Time	t_{EHDX}	0	—	0	—	0	—	0	—	ns	
Write Recovery Time	t_{EHAX}	0	—	0	—	0	—	0	—	ns	

NOTES:

1. A write occurs during the overlap of \bar{E} low and \bar{W} low.
2. Product sensitivities to noise require proper grounding and decoupling of power supplies as well as minimization or elimination of bus contention conditions during read and write cycles.
3. If \bar{G} goes low coincident with or after \bar{W} goes low, the output will remain in a high-impedance state.
4. All write cycle timing is referenced from the last valid address to the first transitioning address.
5. If \bar{E} goes low coincident with or after \bar{W} goes low, the output will remain in a high impedance condition.
6. If \bar{E} goes high coincident with or before \bar{W} goes high, the output will remain in a high impedance condition.

WRITE CYCLE 2 (\bar{E} Controlled, See Notes 1, 2, and 3)

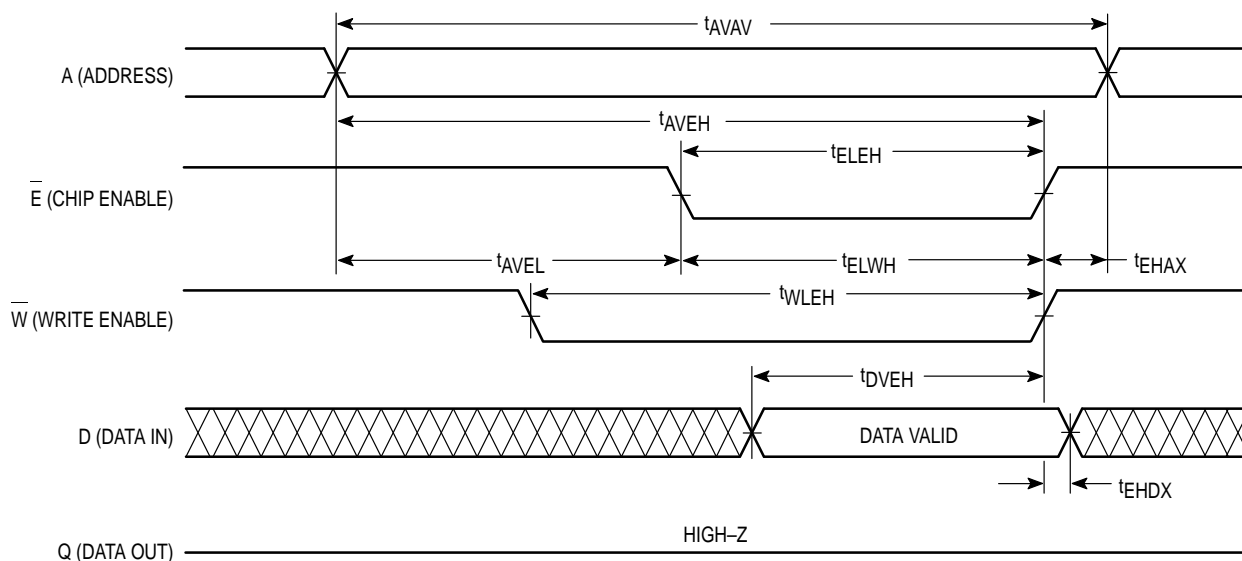

ORDERING INFORMATION
(Order by Full Part Number)

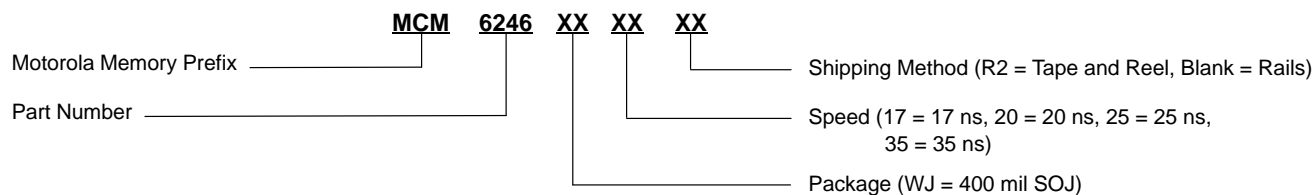

Full Part Numbers — MCM6246WJ17 MCM6246WJ17R2
 MCM6246WJ20 MCM6246WJ20R2
 MCM6246WJ25 MCM6246WJ25R2
 MCM6246WJ35 MCM6246WJ35R2

PACKAGE DIMENSIONS

400 MIL SOJ
CASE 893-01

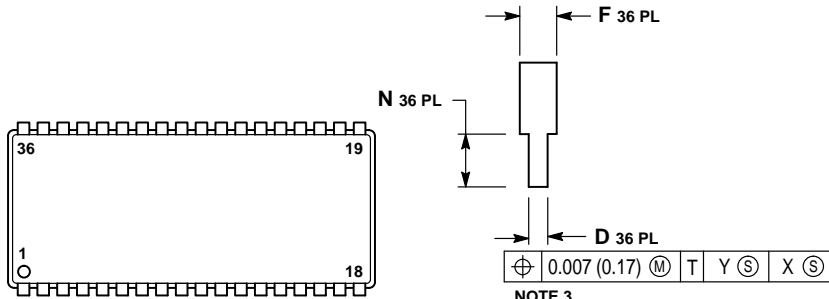

NOTE 3
DETAIL A

- NOTES:
1. DIMENSIONING AND TOLERANCING PER ANSI Y14.5M, 1982.
 2. CONTROLLING DIMENSION: INCH.
 3. TO BE DETERMINED AT PLANE -T-.
 4. DIMENSION A AND B DO NOT INCLUDE MOLD PROTRUSION. MOLD PROTRUSION SHALL NOT EXCEED 0.006 (0.15) PER SIDE.
 5. DIMENSION A AND B INCLUDE MOLD MISMATCH AND ARE DETERMINED AT THE PARTING LINE.

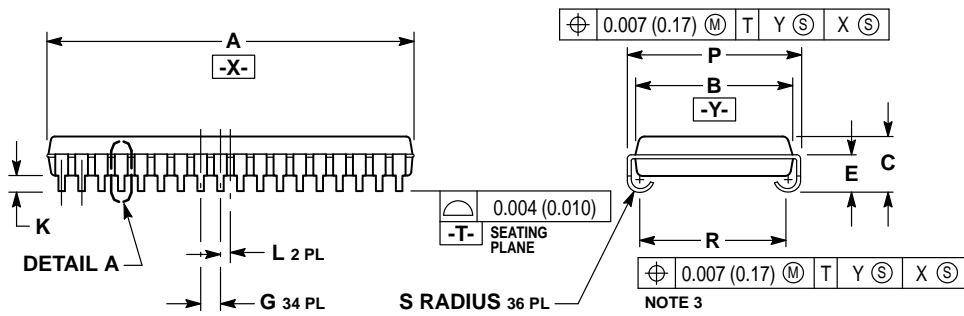

DIM	INCHES		MILLIMETERS	
	MIN	MAX	MIN	MAX
A	0.920	0.930	23.37	23.62
B	0.395	0.405	10.04	10.28
C	0.128	0.148	3.26	3.75
D	0.016	0.020	0.41	0.50
E	0.088	0.098	2.24	2.48
F	0.026	0.032	0.67	0.81
G	0.050 BASIC		1.27 BASIC	
K	0.035	0.045	0.89	1.14
L	0.025 BASIC		0.64 BASIC	
N	0.030	0.045	0.77	1.14
P	0.435	0.445	11.05	11.30
R	0.365	0.375	9.28	9.52
S	0.030	0.040	0.77	1.01

Motorola reserves the right to make changes without further notice to any products herein. Motorola makes no warranty, representation or guarantee regarding the suitability of its products for any particular purpose, nor does Motorola assume any liability arising out of the application or use of any product or circuit, and specifically disclaims any and all liability, including without limitation consequential or incidental damages. "Typical" parameters which may be provided in Motorola data sheets and/or specifications can and do vary in different applications and actual performance may vary over time. All operating parameters, including "Typicals" must be validated for each customer application by customer's technical experts. Motorola does not convey any license under its patent rights nor the rights of others. Motorola products are not designed, intended, or authorized for use as components in systems intended for surgical implant into the body, or other applications intended to support or sustain life, or for any other application in which the failure of the Motorola product could create a situation where personal injury or death may occur. Should Buyer purchase or use Motorola products for any such unintended or unauthorized application, Buyer shall indemnify and hold Motorola and its officers, employees, subsidiaries, affiliates, and distributors harmless against all claims, costs, damages, and expenses, and reasonable attorney fees arising out of, directly or indirectly, any claim of personal injury or death associated with such unintended or unauthorized use, even if such claim alleges that Motorola was negligent regarding the design or manufacture of the part. Motorola and  are registered trademarks of Motorola, Inc. Motorola, Inc. is an Equal Opportunity/Affirmative Action Employer.

Mfax is a trademark of Motorola, Inc.

How to reach us:

USA/EUROPE/Locations Not Listed: Motorola Literature Distribution;
P.O. Box 5405, Denver, Colorado 80217. 303-675-2140 or 1-800-441-2447

JAPAN: Nippon Motorola Ltd.: SPD, Strategic Planning Office, 4-32-1,
Nishi-Gotanda, Shinagawa-ku, Tokyo 141, Japan. 81-3-5487-8488

Mfax™: RMFAX0@email.sps.mot.com – TOUCHTONE 602-244-6609
– US & Canada ONLY 1-800-774-1848

ASIA/PACIFIC: Motorola Semiconductors H.K. Ltd.; 8B Tai Ping Industrial Park,
51 Ting Kok Road, Tai Po, N.T., Hong Kong. 852-26629298

INTERNET: <http://motorola.com/sps>

