

液晶之友 电话: 020-33819057
Http://www.lcdfriends.com

HANTRONIX

PRODUCT SPECIFICATION

HDM3224-CL

320x240 COLOR GRAPHICS
LCD DISPLAY MODULE

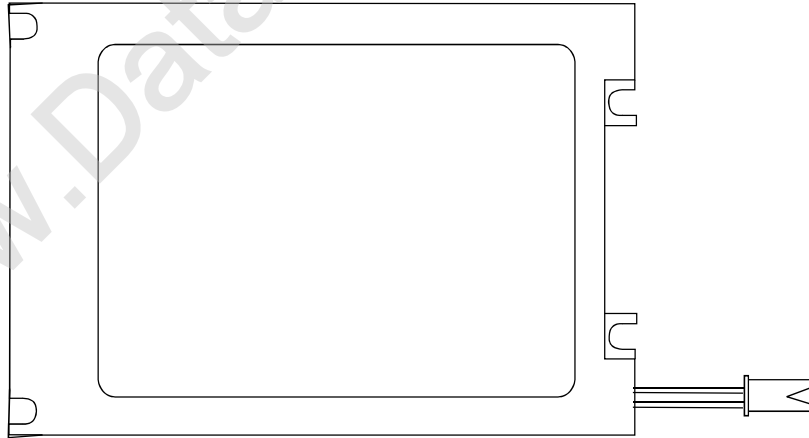

HANTRONIX, INC. 10080 BUBB RD. CUPERTINO, CA 95014	Q.A.:	REV.:	HDM3224-CL	SHEET 1 OF 20
	JK	2.0		DATE: 3/7/03

1. MECHANICAL DATA

(1) Product No.	HDM3224-CL
(2) Module Size	154.6 (W)mm x 114.8 (H)mm x 9.0 (D)mm
(3) Dot Size	0.09 (W)mm x 0.33 (H)mm
(4) Dot Pitch	0.12 (W)mm x 0.36 (H)mm
(5) Number of Dots	320 (W)xRGB x 240 (H)DOTS
(6) Duty	1/240
(7) LCD	F-STN: Color STN module Rear Polarizer: Color Transmissive Type
(8) Viewing Direction	6 O'clock
(9) Backlight	CCFL
(10) Controller	Excluded
(11) DC/DC Converter	Included
(12) Weight	195 g(approx.)

HANTRONIX, INC.
10080 BUBB RD.
CUPERTINO, CA 95014

Q.A.:

JK

REV.:

2.0

HDM3224-CL

SHEET 2 OF 20

DATE:

3/7/03

2. ABSOLUTE MAXIMUM RATINGS

(1) ELECTRICAL ABSOLUTE RATINGS

VSS=0V

ITEM	SYMBOL	MIN	MAX	UNIT	COMMENT
Power Supply for Logic	VDD-VSS	-0.3	7.0	V	
Input Voltage	VI	-0.3	VDD+0.3	V	
Vcon Voltage	Vcon	1.0	3.0	V	
Static Electricity	-	-	-	-	Note 1

(2) ENVIRONMENTAL ABSOLUTE MAXIMUM RATINGS

ITEM	OPERATING		STORAGE	
	MIN.	MAX.	MIN.	MAX.
Ambient Temperature	0	50	-20	70
Humidity (Without Condensation)	Note 2,4		Note 3,4	
Vibration	Note 5			

Note 1 LCM should be grounded during handling LCM.

Note 2 $T_a \leq 50^\circ\text{C}$: 85%RH max

$T_a > 50^\circ\text{C}$: Absolute humidity must be lower
than the humidity of 85%RH at 50°C

Note 3 T_a at -20°C will be < 48 hrs, at 70°C will be < 120 hrs

Note 4 Background color will change slightly depending on ambient temperature.
That phenomenon is reversible.

Note 5

Frequency	5 Hz~13.95 Hz	13.95 Hz~33 Hz	33 Hz~51 Hz	51 Hz~500 Hz
Vibration Level	-	2X9.8 m/s ²	-	5x9.8 m/s ²
Vibration Width	0.2 inch	-	0.036 inch	-
Vibration Direction	X/Y/Z			
Vibration Time	20 min/cycle X 3 directions			

HANTRONIX, INC. 10080 BUBB RD. CUPERTINO, CA 95014	Q.A.:	REV.:	HDM3224-CL	SHEET 3 OF 20
	JK	2.0		DATE:

3. ELECTRICAL CHARACTERISTICS

3-1. ELECTRICAL CHARACTERISTICS OF LCM

T_a=25°C, VDD=5V±5%

ITEM		SYMBOL	CONDITION	MIN.	TYP.	MAX.	UNIT
Logic Circuit Power Supply		VDD-VSS	T _a = 25°C	4.5	5.0	5.5	v
Input Voltage		V _{IH}	H level	0.8VDD	-	VDD	v
		V _{IL}	L level	0	-	0.2VDD	v
Contrast Adjust Voltage		V _{con} -V _{ss}	Duty=1/240 Bias=1/13 VDD=5.0V 0°C 50°C	1.0	1.8	3.0	v
Supply Current for Logic		I _{DD}	VDD-VSS = 5.0V VCON-VSS = 1.8V T _a = 25°C PATTERN: □ ■ □ ■ □ ■ □ ■ ■ □ ■ □ ■ □ ■ □	-	33.0	50.0	mA
		I _{CON}		-	0.7	1.0	
LCM	Surface Luminance	L	T606M PATTERN: (Dots All On of White Color) □ □ □ □ □ □ □ □	-	194	-	cd/m ²
			T606M PATTERN: (Dots All Off) ■ ■ ■ ■ ■ ■ ■ ■	-	6.3	-	

HANTRONIX, INC. 10080 BUBB RD. CUPERTINO, CA 95014	Q.A.:	REV.:	HDM3224-CL	SHEET 4 OF 20
	JK	2.0		DATE:

3-2.ELECTRICAL CHARACTERISTICS OF BACKLIGHT

Used lamp : Rating

PARAMETER	SYMBOL	MIN.	TYP.	MAX.	UNIT	REMARK
Lamp Voltage	V _L	-	474	-	Vrms	-
Lamp current	I _L	2	5	6	mArms	
Lamp power consumption	P _L	-	2.37	-	W	(*1)
Starting Voltage	V _S	-	-	750	Vrms	T _a =25°C
		-	-	940	Vrms	T _a =0°C
Lamp frequency	F _L	35	50	65	KHz	
Lamp life time	LL	-	40000	-	hrs	IL = 5 mArms(*2)

(*1) Power consumption excluded inverter loss .

(*2) Lamp life time is defined as follows : The final brightness is at 50% of original brightness .

HANTRONIX, INC.
10080 BUBB RD.
CUPERTINO, CA 95014

Q.A.:

JK

REV.:

2.0

HDM3224-CL

SHEET 5 OF 20

DATE:

3/7/03

3.3 RECOMMENDED INVERTER (TDK TBD086N-3) (Brightness Fixed)

TDK TBD086N-3

3-3-1 GENERAL SPECIFICATIONS

OPERATION TEMPERATURE : 0°C~55°C

STORAGE TEMPERATURE : -20°C~80°C

DIMENSION : 95.0(L)mm x 19.5(W)mm x MAX 6.5(H)mm

3-3-2 INPUT CHARACTERISTICS

PARAMETER	SYMBOL	MIN.	TYP.	MAX.	UNIT	REMARKS
Input Voltage	Vin	11.4	12.0	12.6	V	
Input Current	Iin	-	250	300	mA	
CTL Input Voltage	Vrmt	2.8	3	3.2	V	ON state
		-0.5	0	0.5	V	OFF state

3-3-3 PIN ASSIGNMENTS

INPUT (CN1) CONNECTOR :
MOLEX 53261-0590 or E&T 3802-05

OUTPUT (CN2) CONNECTOR :
JST SM02-(8.0)B-BHS-1

NO.	FUNCTION
1	VIN(12.0V)
2	GND
3	Vrmt
4	N.C
5	N.C

NO.	FUNCTION
1	HV
2	RTN

3-3-4 OUTPUT CHARACTERISTICS

PARAMETER	SYMBOL	MIN.	TYP.	MAX.	UNIT	REMARKS
Input Voltage	VIN	11.4	12.0	12.6	V	
Tube Current	IL	-	5.0	-	mA	

Note : Inverter must be used in the range of VIN Input Voltage.

If it doesn't used in this range, the electrical characteristics of backlight would not be to guarantee.

HANTRONIX, INC. 10080 BUBB RD. CUPERTINO, CA 95014	Q.A.:	REV.:	HDM3224-CL	SHEET 6 OF 20
	JK	2.0		DATE:

4. OPTICAL CHARACTERISTICS

4-1. Optical Char. of Normal Temp. Mode

AT Vop

ITEM MODE		Cr(Contrast Ratio)						θ (Viewing Angle)		ϕ (Viewing Angle)	
		0°C		25°C		50°C		25°C		25°C	
		MIN.	TYP.	MIN.	TYP.	MIN.	TYP.	MIN.	TYP.	MIN.	TYP.
T	M	20	30	25	35	5	10	-	F: 60 R: 40	-	±55
NOTE		NOTE 6						NOTE 5			

note:

T: TRANSMISSIVE

M: FOR 6 O'CLOCK STN MODULE

AT $\phi=0^\circ$ $\theta=0^\circ$

ITEM	SYMBOL	CONDITION	MIN.	TYP.	MAX.	UNIT	NOTE
Response Time (rise)	Tr	0°C	-	750	900	ms	NOTE 2
		25°C	-	300	400		
		50°C	-	130	160		
Response Time (fall)	Tf	0°C	-	350	450	ms	NOTE 2
		25°C	-	80	120		
		50°C	-	60	70		

HANTRONIX, INC.
10080 BUBB RD.
CUPERTINO, CA 95014

Q.A.:
JK

REV.:
2.0

HDM3224-CL

SHEET 7 OF 20

DATE:
3/7/03

4-2. Color of CIE Coordinate

To = 25°C

ITEM		SYMBOL	CONDITION	VALUE	BRIGHTNESS (cd/m ²)	NOTE
Color of CIE Coordinate	Red	X	$\phi=0^\circ, \theta=0^\circ$	0.583	59.6	Note*
		y		0.291		
	Green	X		0.318	118.0	
		y		0.499		
	Blue	X		0.154	29.5	
		y		0.084		
	White	X		0.316	194.0	
		y		0.263		

Note* Measuring at position 3 on Fig.1
CIE chromaticity diagram

Tolerance : ±0.05

Fig.1

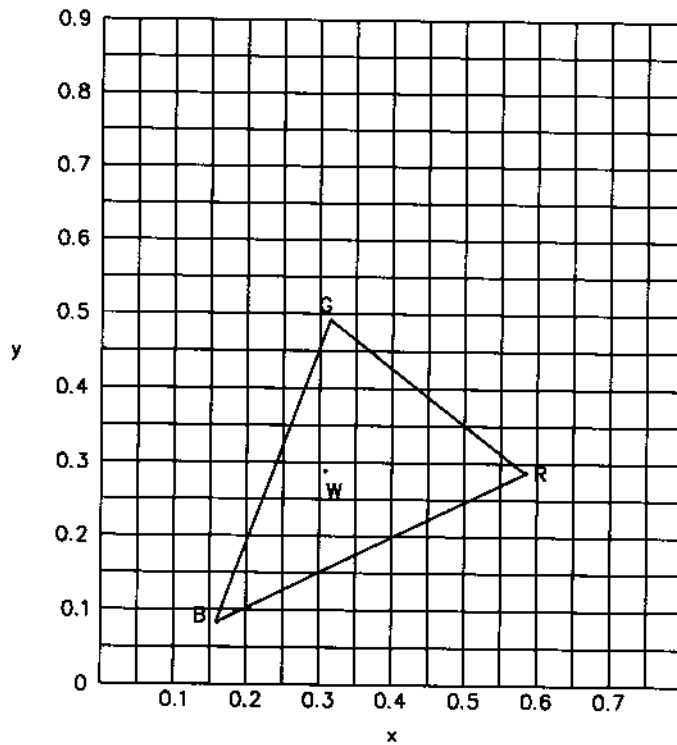

HANTRONIX, INC.
10080 BUBB RD.
CUPERTINO, CA 95014

Q.A.:
JK

REV.:
2.0

HDM3224-CL

SHEET 8 OF 20

DATE:
3/7/03

(NOTE 1)

Definition of Operation Voltage(Vop)

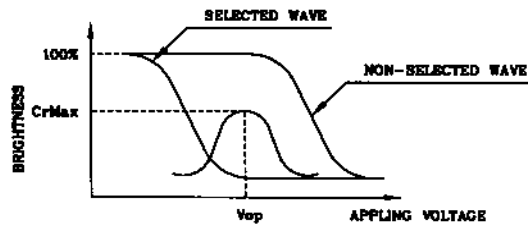

(positive type)

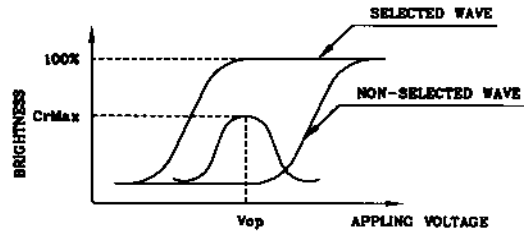

(negative type)

***Conditions**

Viewing Angle : 0
 Frame Frequency : 140Hz
 Applying Waveform : 1/N duty 1/a bias

(NOTE 2)

Definition of Response Time(Tr,Tf)

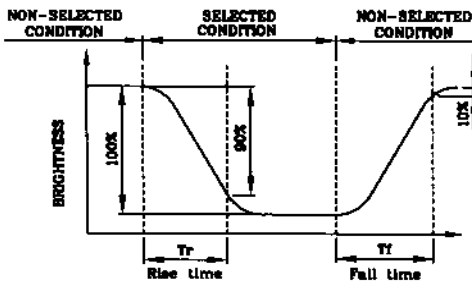

(positive type)

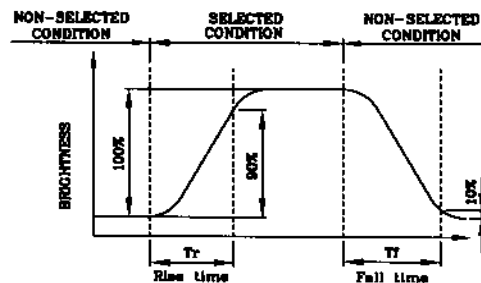

(negative type)

***Conditions**

Operating Voltage : Vop
 Viewing Angle (θ,φ) : (0,0)
 Frame Frequency : 140Hz
 Applying Waveform : 1/N duty 1/a bias

(NOTE 3)

Description of Measuring Equipment and Driving Waveforms

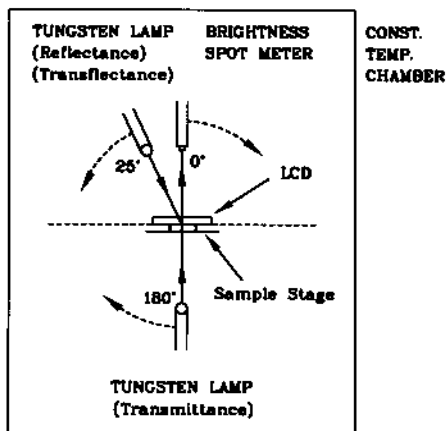

The voltage relationship of each signal is as follow
 Multiplex Driving (1/N duty 1/a bias)

Segment voltage	Segment Waveform	Common Waveform	Common voltage
V0 VM V1			VH
	Normally display period	Off-display period	VM
	Off-display period	Normally display period	VL
	Off-display period	Off-display period	

HANTRONIX, INC.
 10080 BUBB RD.
 CUPERTINO, CA 95014

Q.A.:
 JK

REV.:
 2.0

HDM3224-CL

SHEET 9 OF 20

DATE:
 3/7/03

(NOTE 4)

Definition of Viewing Direction

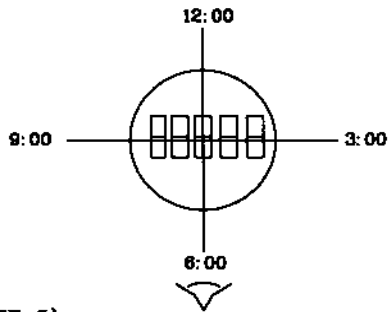

(NOTE 5)

Definition of Viewing Angle

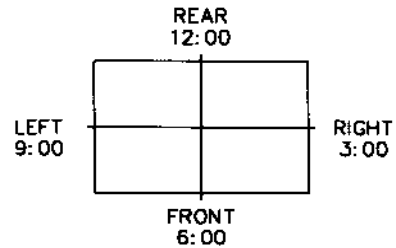
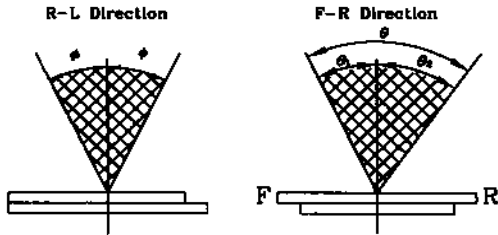

*For This Product
The Viewing Direction is 6 O'clock
So $\theta_1 > \theta_2$

$$\theta = \theta_1 + \theta_2$$

*Conditions

Operating Voltage : V_{op}
Frame Frequency : 140Hz
Applying Waveform : 1/N duty 1/a bias
Contrast Ratio : larger than 2

(NOTE 6)

Definition of Contrast Ratio (Cr)

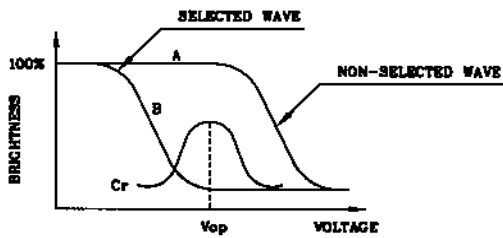

(positive type)

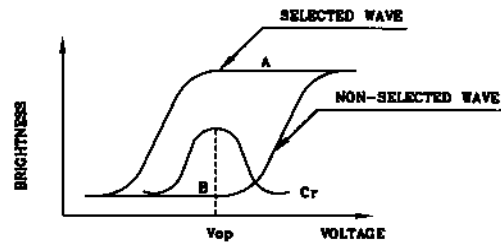

(negative type)

$$\text{Contrast Ratio : } Cr = A/B$$

*Conditions

Viewing Angle : 0
Frame Frequency : 140Hz
Applying Waveform : 1/N duty 1/a bias

HANTRONIX, INC.
10080 BUBB RD.
CUPERTINO, CA 95014

Q.A.:
JK

REV.:
2.0

HDM3224-CL

SHEET 10 OF 20

DATE:
3/7/03

5. BLOCK DIAGRAM

LCD

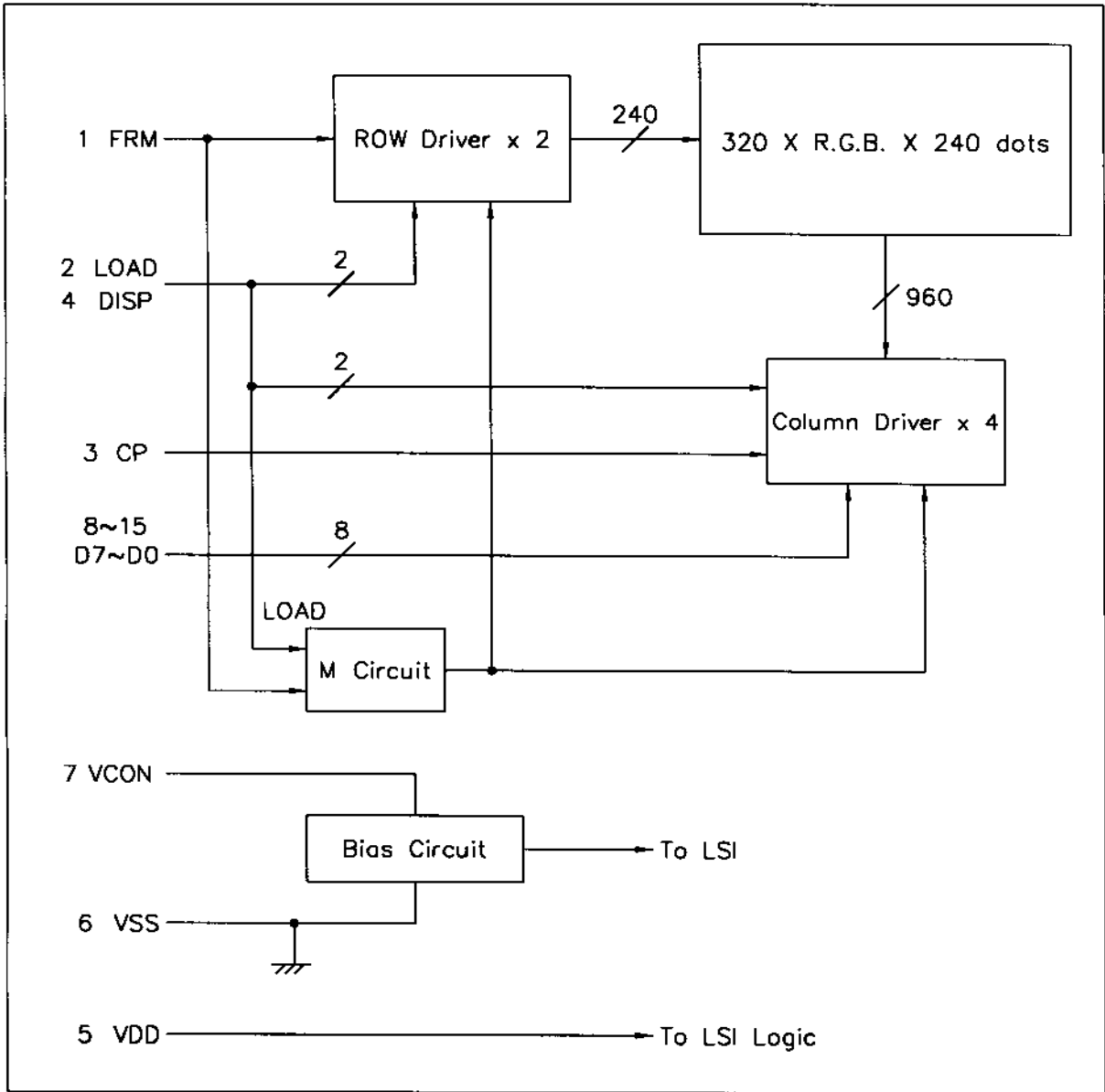

CCFL

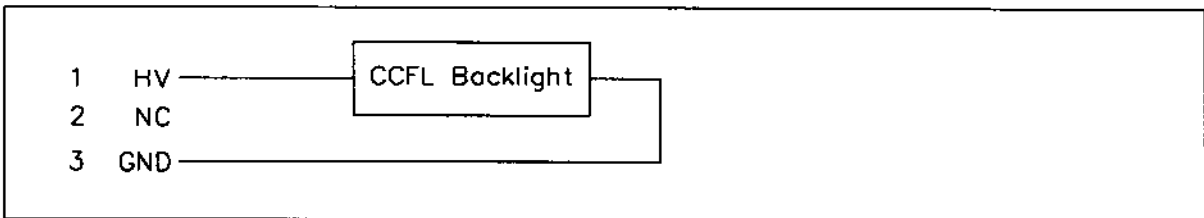

HANTRONIX, INC.
10080 BUBB RD.
CUPERTINO, CA 95014

Q.A.:
JK

REV.:
2.0

HDM3224-CL

SHEET 11 OF 20

DATE:
3/7/03

6. INTERNAL PIN CONNECTION

LCD

Pin No.	Symbol	Level	Function
1	FRM	H	Synchronous Signal for Driving Scanning Line
2	LOAD	H→L	Data Signal Latch Clock
3	CP	H→L	Data Signal Shift Clock
4	DISP	H/L	Display Control Signal, H : Display on L : Display off
5	VDD	-	Power Supply for Logic
6	VSS	-	Power Supply (0V,GND)
7	VCON	-	Contrast Adjust
8	D7	H/L	Display Data
9	D6	H/L	Display Data
10	D5	H/L	Display Data
11	D4	H/L	Display Data
12	D3	H/L	Display Data
13	D2	H/L	Display Data
14	D1	H/L	Display Data
15	D0	H/L	Display Data

CN1 : 53261-1510(Molex)

Recommended Matching Connector : 51021-1500(Molex) or Compatible

CCFL

Pin No.	Symbol	Level	Function
1	HV	AC	Power Supply for CCFL(HOT)
2	NC	-	Non-connection
3	GND	-	Power Supply for CCFL(GND)

CN2 : BHR-03VS-1(JST)

Recommended Matching Connector : SM02-(8.0)B-BHS-1(JST) or Compatible

HANTRONIX, INC. 10080 BUBB RD. CUPERTINO, CA 95014	Q.A.:	REV.:	HDM3224-CL	SHEET 12 OF 20
	JK	2.0		DATE:

7. POWER SUPPLY

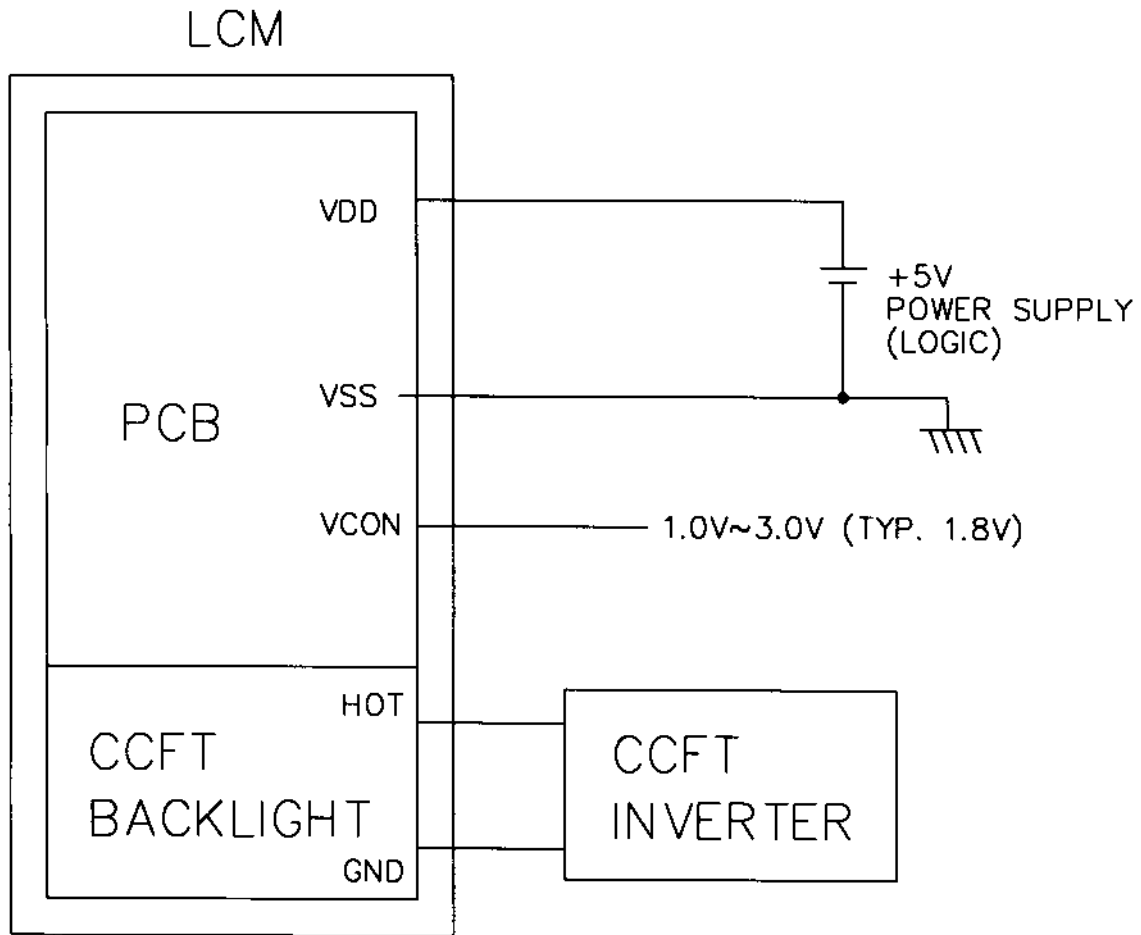

Recommended :

1. $R1 + R2 + VR = 10 \sim 20K \Omega$

2. $C1, C2 = 10 \mu F$

HANTRONIX, INC. 10080 BUBB RD. CUPERTINO, CA 95014	Q.A.:	REV.:	HDM3224-CL	SHEET 13 OF 20
	JK	2.0		DATE:

8. TIMING CHARACTERISTICS

8-1 INTERFACE TIMING

● VDD=5.0V±10%, To=-20~70 °C

Item	Symbol	Test condition	Min.	Typ.	Max.	Unit
CP Clock Cycle	tCYC2	Fig.a	162	-	-	ns
CP HIGH-LEVEL Width	tCWH2	Fig.a	66	-	-	ns
CP LOW-LEVEL Width	tCWL2	Fig.a	66	-	-	ns
Data Set Up Time	tDSE	Fig.a	50	-	-	ns
Data Hold Time	tDH2	Fig.a	50	-	-	ns
CP Rise/Fall Time	tr2,tf2	Fig.a	-	-	30	ns
Clock Set Up Time	tSCL	Fig.a	80	-	-	ns
Clock Hold Time	tHCL	Fig.a	80	-	-	ns
M Set Up Time	tMS	Fig.a	20	-	-	ns
M Hold Time	tMH	Fig.a	20	-	-	ns

● VDD=5.0V±10%, To=-20~70 °C

Item	Symbol	Test condition	Min.	Typ.	Max.	Unit
LOAD Clock Cycle	tCYC1	Fig.b	400	-	-	ns
LOAD HIGH-LEVEL Width	tCWH1	Fig.b	25	-	-	ns
LOAD LOW-LEVEL Width	tCWL1	Fig.b	370	-	-	ns
Data Set Up Time	tDS1	Fig.b	100	-	-	ns
Data Hold Time	tDH1	Fig.b	10	-	-	ns
LOAD Rise/Fall Time	tr1,tf1	Fig.b	-	-	30	ns

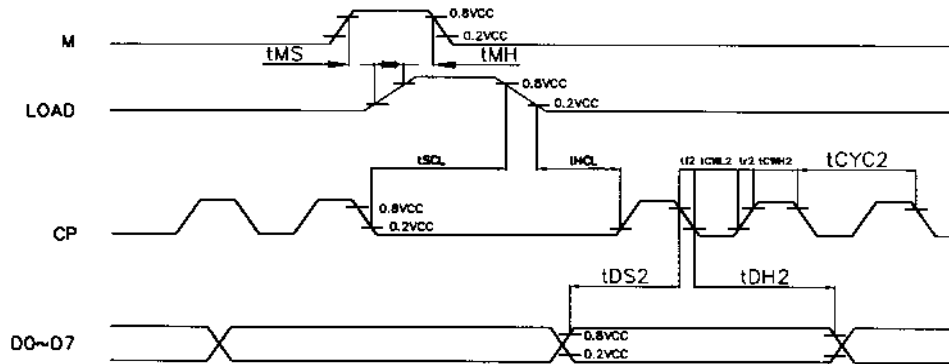

Fig . a Interface timing (SEGMENT)

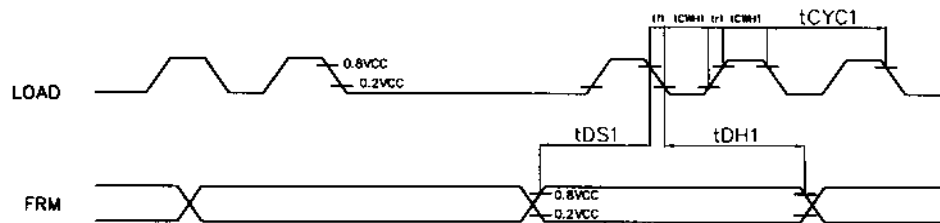
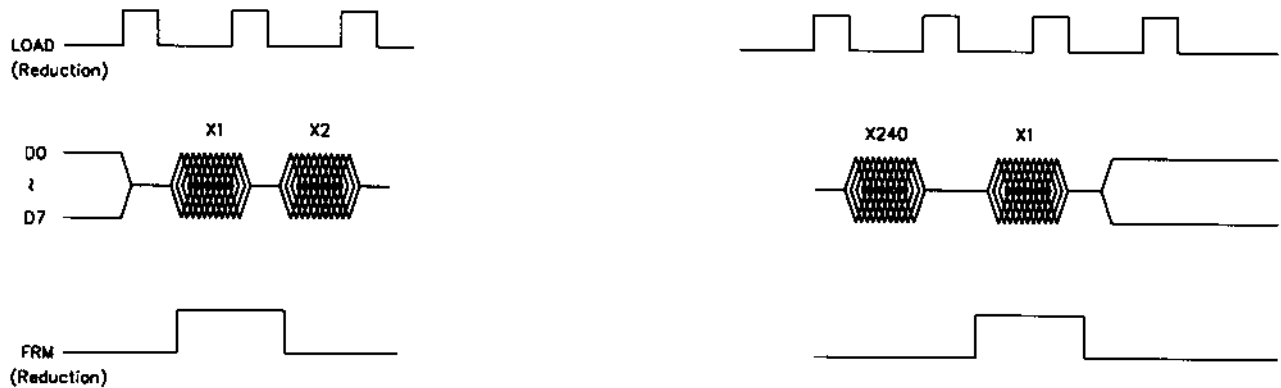
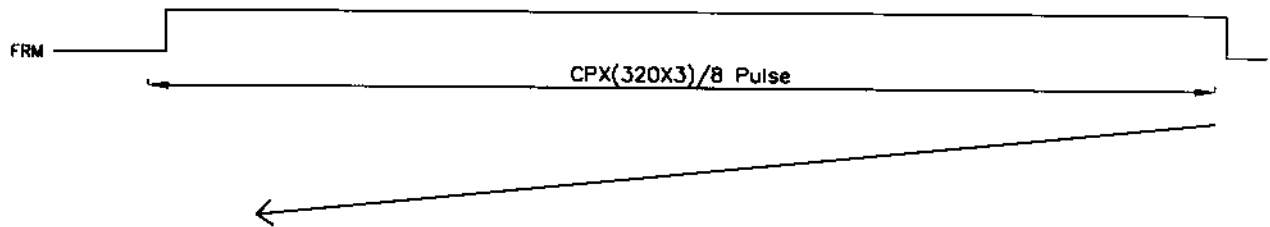
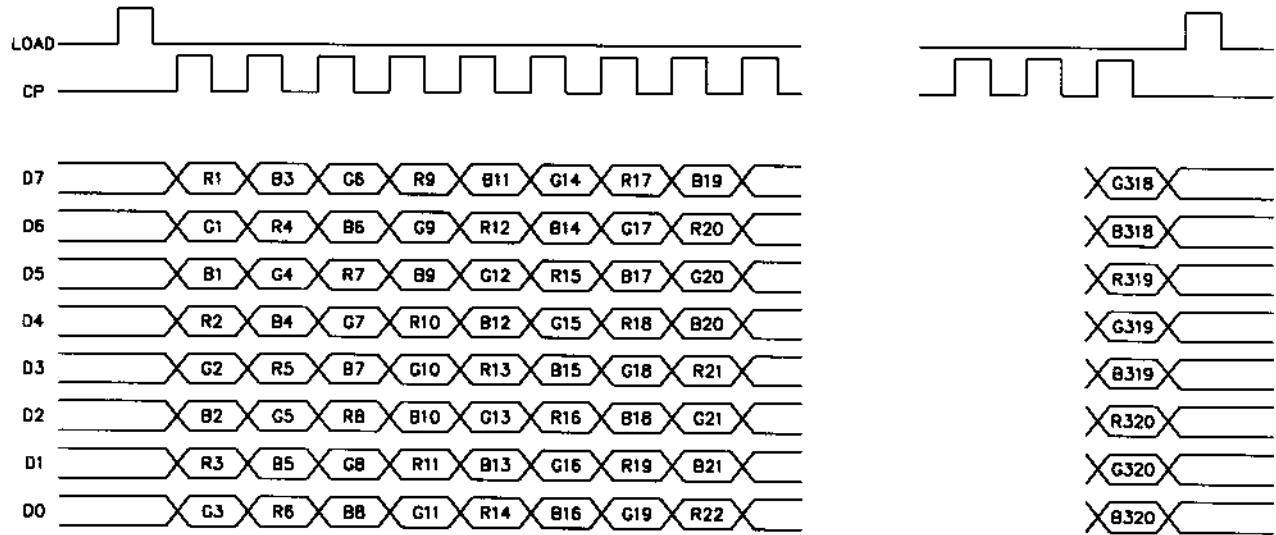

Fig . b Interface timing (COMMON)

HANTRONIX, INC. 10080 BUBB RD. CUPERTINO, CA 95014	Q.A.:	REV.:	HDM3224-CL	SHEET 14 OF 20
	JK	2.0		DATE:

8-2. TIMING CHART



HANTRONIX, INC. 10080 BUBB RD. CUPERTINO, CA 95014	Q.A.: JK	REV.: 2.0	<h3 style="margin: 0;">HDM3224-CL</h3>	SHEET 15 OF 20 <hr/> DATE: 3/7/03
---	-------------	--------------	--	---

8-3.POWER ON/OFF TIMING

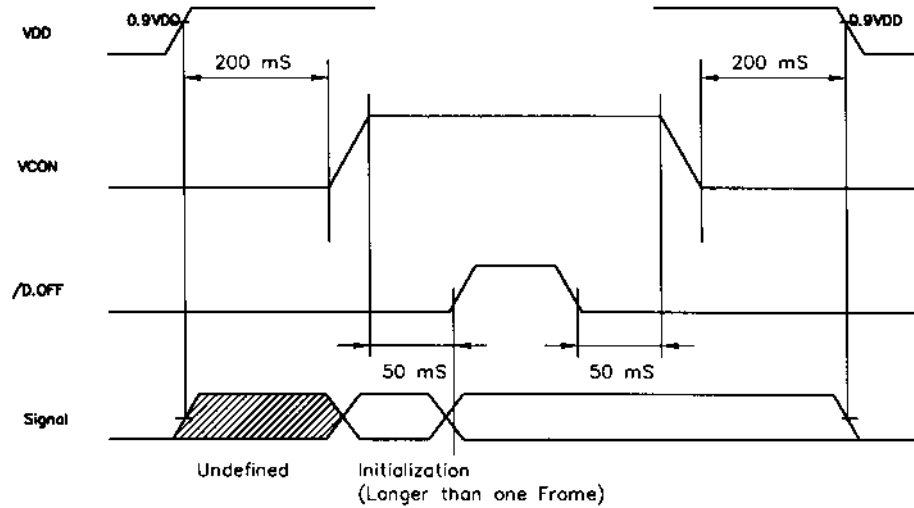

POWER ON

POWER OFF

The missing pixels may occur when the LCM is driven beyond above power interface timing sequence.

HANTRONIX, INC. 10080 BUBB RD. CUPERTINO, CA 95014	Q.A.:	REV.:	HDM3224-CL	SHEET 16 OF 20
	JK	2.0		DATE:

8-4.DISPLAY PATTERN

START DATA

	Y1			Y2			Y3		
x1	R1	G1	B1	R2	G2	B2	R3	G3	B3
	D7	D6	D5	D4	D3	D2	D1	D0	D7
x2	R1	G1	B1	R2	G2	B2	R3	G3	B3
	D7	D6	D5	D4	D3	D2	D1	D0	D7

Y318			Y319			Y320		
R318	G318	B318	R319	G319	B319	R320	G320	B320
D0	D7	D6	D5	D4	D3	D2	D1	D0
R318	G318	B318	R319	G319	B319	R320	G320	B320
D0	D7	D6	D5	D4	D3	D2	D1	D0

x239	R1	G1	B1	R2	G2	B2	R3	G3	B3
	D7	D6	D5	D4	D3	D2	D1	D0	D7
x240	R1	G1	B1	R2	G2	B2	R3	G3	B3
	D7	D6	D5	D4	D3	D2	D1	D0	D7

R318	G318	B318	R319	G319	B319	R320	G320	B320
D0	D7	D6	D5	D4	D3	D2	D1	D0
R318	G318	B318	R319	G319	B319	R320	G320	B320
D0	D7	D6	D5	D4	D3	D2	D1	D0

HANTRONIX, INC.
10080 BUBB RD.
CUPERTINO, CA 95014

Q.A.:
JK

REV.:
2.0

HDM3224-CL

SHEET 17 OF 20

DATE:
3/7/03

9. RELIABILITY TEST

NO	ITEM	CONDITION			STANDARD	NOTE
1	High Temp. Storage	70°C 30%RH	120HR		Appearance without defect	
2	Low Temp. Storage	-20°C	120HR		Appearance without defect	
3	High Temp. & High Humi. Storage	40°C 90%RH	120HR		Appearance without defect	
4	Thermal Shock	-20°C, 30min → 25°C, 5min → 70°C, 30min → 25°C, 5min (1cycle)			Appearance without defect	5 cycles

HANTRONIX, INC.
10080 BUBB RD.
CUPERTINO, CA 95014

Q.A.:

JK

REV.:

2.0

HDM3224-CL

SHEET 18 OF 20

DATE:

3/7/03

NOTE:

• SAFETY

- 1.If the LCD panel breaks, be careful not to get the liquid crystal to touch your skin.
- 2.If the liquid crystal touches your skin or clothes, please wash it off immediately by using soap and water.

• HANDLING

- 1.Avoid static electricity which can damage the CMOS LSI.
- 2.Do not remove the panel or frame from the module.
- 3.The polarizing plate of the display is very fragile. So, please handle it very carefully.
- 4.Do not wipe the polarizing plate with a dry cloth, as it may easily scratch the surface of plate.
- 5.Do not use ketonics solvent & Aromatic solvent, use with a soft cloth soaked with a cleaning naphtha solvent.

• STORAGE

- 1.Store the panel or module in a dark place where the temperature is $25^{\circ}\text{C}\pm 5^{\circ}\text{C}$ and the humidity is below 65% RH.
- 2.Do not place the module near organics solvents or corrosive gases.
- 3.Do not crush, shake, or jolt the module.

• TERMS OF WARRANT

- 1.Acceptance inspection period
The period is within one month after the arrival of contracted commodity at the buyer's factory site.
- 2.Applicable warrant period
The period is within twelve months since the date of shipping out under normal using and storage conditions.

HANTRONIX, INC. 10080 BUBB RD. CUPERTINO, CA 95014	Q.A.: JK	REV.: 2.0	HDM3224-CL	SHEET 19 OF 20
				DATE: 3/7/03

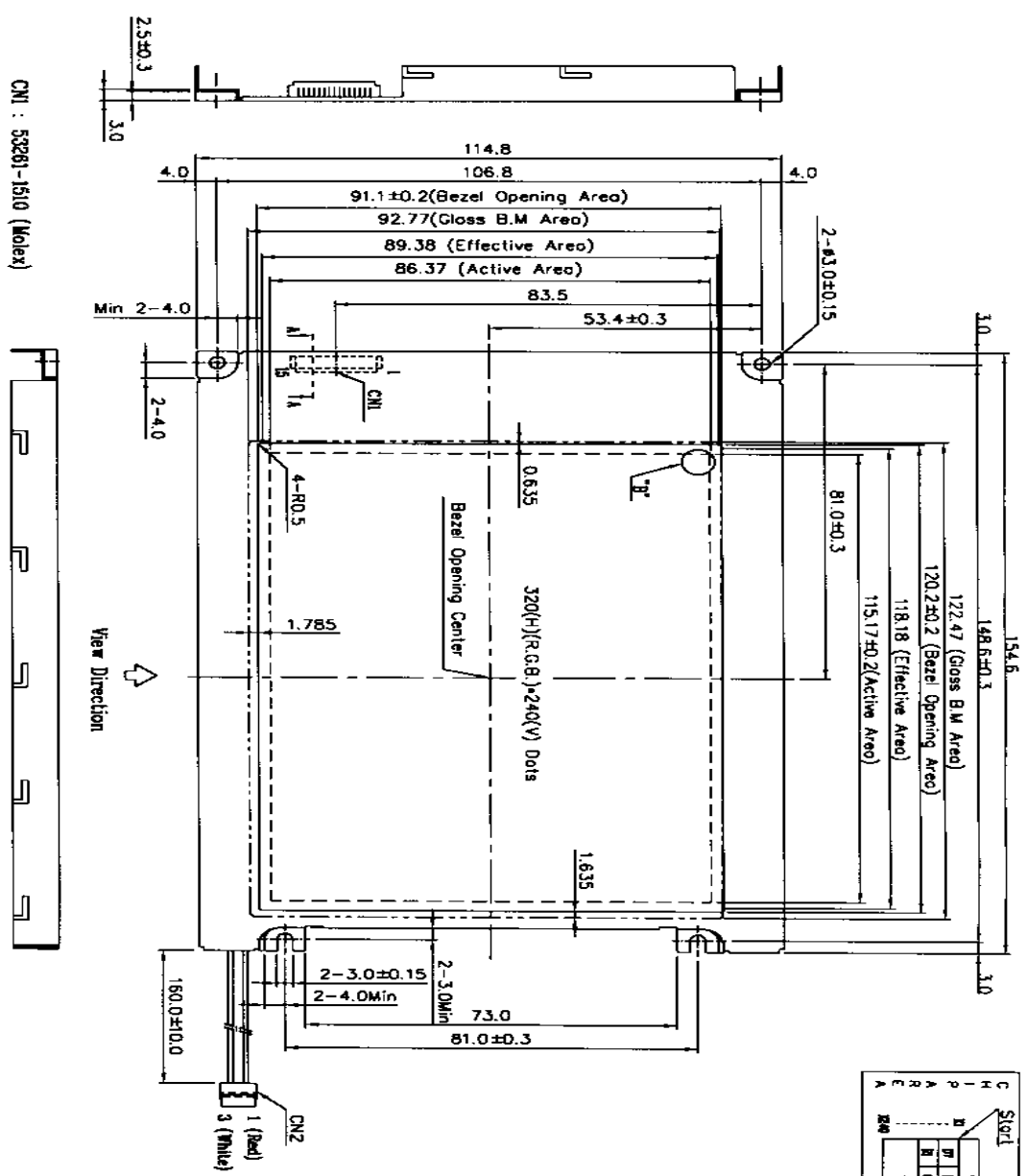

CN1 : 53261-1510 (Molex)

View Direction

Row	Col 1	Col 2	Col 3	Col 4	Col 5	Col 6	Col 7	Col 8	Col 9	Col 10	Col 11	Col 12	Col 13	Col 14	Col 15	Col 16	Col 17	Col 18	Col 19	Col 20
C	1	2	3	4	5	6	7	8	9	10	11	12	13	14	15	16	17	18	19	20
H																				
P																				
A																				
R																				
E																				
A																				

- Notes :
- 1 Resolution : 320(H)(R.C.B) ±240(V) Data
 - 2 Backlight : CCFL
 - 3 Frame Material : SPC (1-0-5)

Detail "B"

0.12	0.09	0.09	0.09
R	G	B	B
3	3	3	3
0	0	0	0

