

# XN09D58

Silicon PNP epitaxial planar type (Tr)  
Silicon epitaxial planar type (SBD)

For DC-DC converter

### ■ Features

- Two elements incorporated into one package (Tr + SBD)
- Reduction of the mounting area and assembly cost by one half
- Low collector-emitter saturation voltage  $V_{CE(sat)}$

### ■ Basic Part Number

- XN9D57 + MA3ZD12

### ■ Absolute Maximum Ratings $T_a = 25^\circ\text{C}$

Parameter	Symbol	Rating	Unit	
Tr	Collector-base voltage (Emitter open)	$V_{CBO}$	-15	V
	Collector-emitter voltage (Base open)	$V_{CEO}$	-15	V
	Emitter-base voltage (Collector open)	$V_{EBO}$	-5	V
	Collector current	$I_C$	-2.5	A
	Peak collector current	$I_{CP}$	-10	A
SBD	Reverse voltage	$V_R$	20	V
	Repetitive peak reverse voltage	$V_{RRM}$	25	V
	Forward current (Average)	$I_{F(AV)}$	700	mA
	Non-repetitive peak forward surge current	$I_{FSM}$	2	A
Overall	Total power dissipation *	$P_T$	600	mW
	Junction temperature	$T_j$	125	$^\circ\text{C}$
	Storage temperature	$T_{stg}$	-55 to +125	$^\circ\text{C}$

Note) \*: Measuring on ceramic substrate at 15 mm × 15 mm × 0.6 mm

### ■ Electrical Characteristics $T_a = 25^\circ\text{C} \pm 3^\circ\text{C}$

- Tr

Parameter	Symbol	Conditions	Min	Typ	Max	Unit
Collector-base voltage (Emitter open)	$V_{CBO}$	$I_C = -10 \mu\text{A}, I_E = 0$	-15			V
Collector-emitter voltage (Base open)	$V_{CEO}$	$I_C = -1 \text{ mA}, I_B = 0$	-15			V
Emitter-base voltage (Collector open)	$V_{EBO}$	$I_E = -10 \mu\text{A}, I_C = 0$	-5			V
Collector-base cutoff current (Emitter open)	$I_{CBO}$	$V_{CB} = -10 \text{ V}, I_E = 0$			-0.1	$\mu\text{A}$
Forward current transfer ratio *	$h_{FE1}$	$V_{CE} = -2 \text{ V}, I_C = -100 \text{ mA}$	200		560	—
	$h_{FE2}$	$V_{CE} = -2 \text{ V}, I_C = -2.5 \text{ A}$	100			—
Collector-emitter saturation voltage *	$V_{CE(sat)}$	$I_C = -1 \text{ A}, I_B = -10 \text{ mA}$		-140		mV
		$I_C = -2.5 \text{ A}, I_B = -50 \text{ mA}$		-270	-320	

Note) 1. Measuring methods are based on JAPANESE INDUSTRIAL STANDARD JIS C 7030 measuring methods for transistors.

2. \*: Pulse measurement

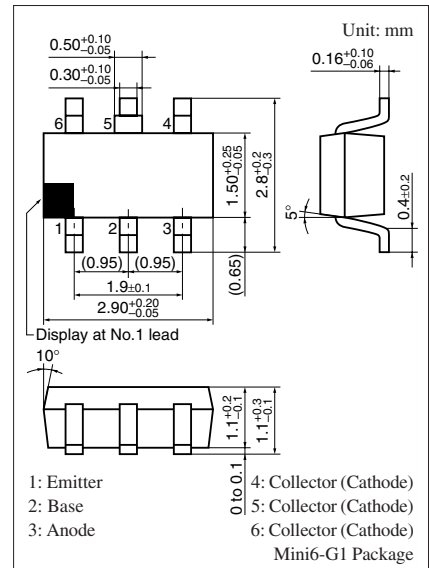

Marking Symbol: EF

Internal Connection

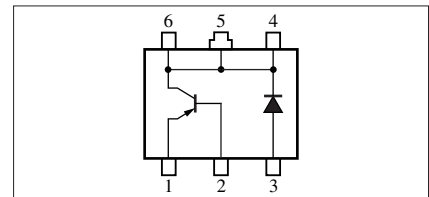

■ Electrical Characteristics (continued)  $T_a = 25^\circ\text{C} \pm 3^\circ\text{C}$

• Tr (continued)

Parameter	Symbol	Conditions	Min	Typ	Max	Unit
Collector output capacitance (Common base, input open circuited)	$C_{ob}$	$V_{CB} = -10\text{ V}, I_E = 0, f = 1\text{ MHz}$		40		pF
Transition frequency	$f_T$	$V_{CB} = -10\text{ V}, I_E = 50\text{ mA}, f = 200\text{ MHz}$		180		MHz
Turn-on time	$t_{on}$	Refer to the switching time measurement circuit		35		ns
Storage time	$t_{stg}$			110		ns
Turn-off time	$t_{off}$			10		ns

Note) Measuring methods are based on JAPANESE INDUSTRIAL STANDARD JIS C 7030 measuring methods for transistors.

Switching time measurement circuit

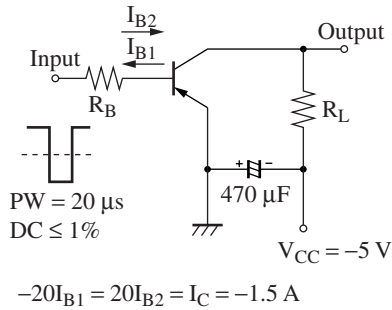

• SBD

Parameter	Symbol	Conditions	Min	Typ	Max	Unit
Forward voltage	$V_F$	$I_F = 700\text{ mA}$			0.45	V
Reverse current	$I_R$	$V_R = 20\text{ V}$			200	$\mu\text{A}$
Terminal capacitance	$C_t$	$V_R = 0, f = 1\text{ MHz}$		100		pF
Reverse recovery time	$t_{rr}$	$I_F = I_R = 100\text{ mA}, I_{rr} = 10\text{ mA}$ $R_L = 100\ \Omega$		7		ns

Note) 1. Measuring methods are based on JAPANESE INDUSTRIAL STANDARD JIS C 7031 Measuring methods for diodes.

2. Schottky barrier diode is frail with static electricity, and it should be kept in safety from shock of static electricity and static electricity level.

Common characteristics chart

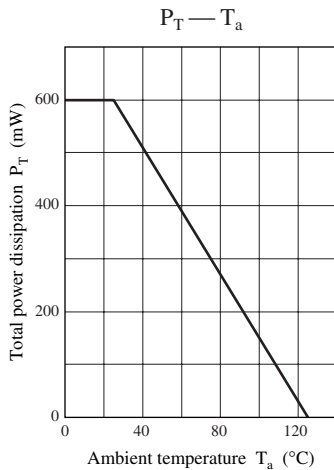

Characteristics charts of Tr

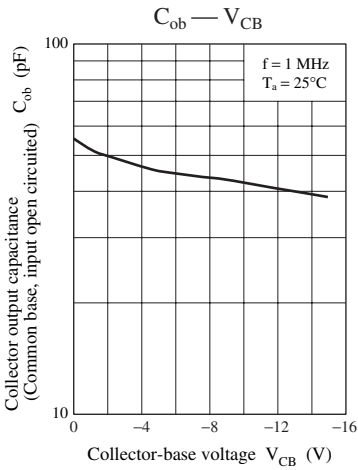
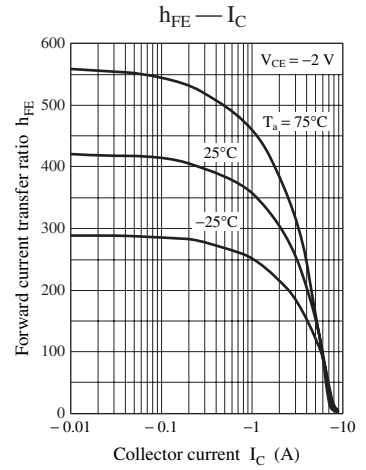
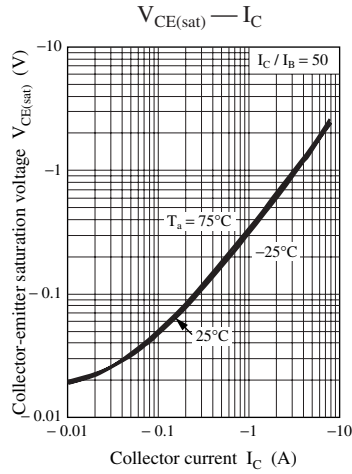
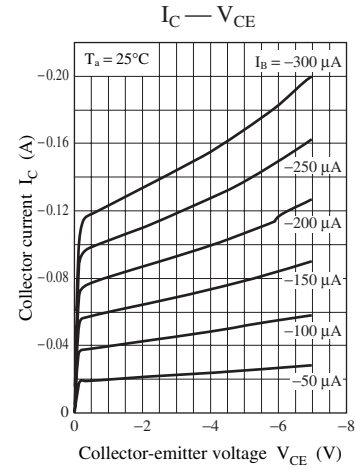

Characteristics charts of SBD

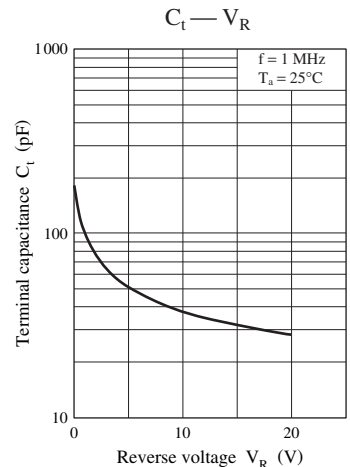
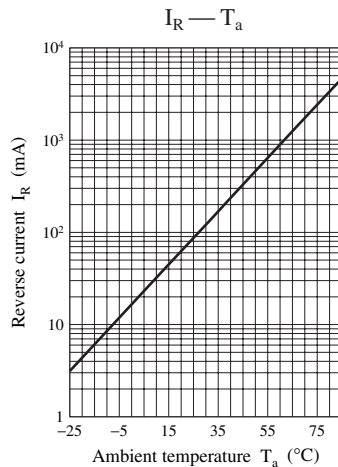
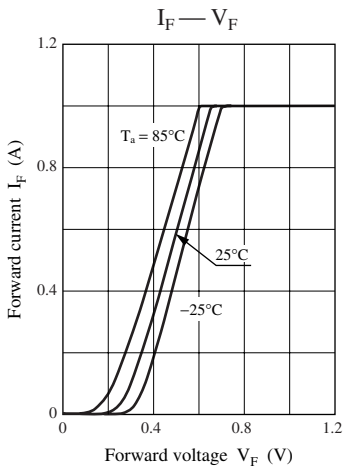

## Request for your special attention and precautions in using the technical information and semiconductors described in this material

- (1) An export permit needs to be obtained from the competent authorities of the Japanese Government if any of the products or technical information described in this material and controlled under the "Foreign Exchange and Foreign Trade Law" is to be exported or taken out of Japan.
- (2) The technical information described in this material is limited to showing representative characteristics and applied circuits examples of the products. It neither warrants non-infringement of intellectual property right or any other rights owned by our company or a third party, nor grants any license.
- (3) We are not liable for the infringement of rights owned by a third party arising out of the use of the technical information as described in this material.
- (4) The products described in this material are intended to be used for standard applications or general electronic equipment (such as office equipment, communications equipment, measuring instruments and household appliances).  
Consult our sales staff in advance for information on the following applications:
  - Special applications (such as for airplanes, aerospace, automobiles, traffic control equipment, combustion equipment, life support systems and safety devices) in which exceptional quality and reliability are required, or if the failure or malfunction of the products may directly jeopardize life or harm the human body.
  - Any applications other than the standard applications intended.
- (5) The products and product specifications described in this material are subject to change without notice for modification and/or improvement. At the final stage of your design, purchasing, or use of the products, therefore, ask for the most up-to-date Product Standards in advance to make sure that the latest specifications satisfy your requirements.
- (6) When designing your equipment, comply with the guaranteed values, in particular those of maximum rating, the range of operating power supply voltage, and heat radiation characteristics. Otherwise, we will not be liable for any defect which may arise later in your equipment.  
Even when the products are used within the guaranteed values, take into the consideration of incidence of break down and failure mode, possible to occur to semiconductor products. Measures on the systems such as redundant design, arresting the spread of fire or preventing glitch are recommended in order to prevent physical injury, fire, social damages, for example, by using the products.
- (7) When using products for which damp-proof packing is required, observe the conditions (including shelf life and amount of time let standing of unsealed items) agreed upon when specification sheets are individually exchanged.
- (8) This material may be not reprinted or reproduced whether wholly or partially, without the prior written permission of Matsushita Electric Industrial Co., Ltd.