

BIPOLAR ANALOG INTEGRATED CIRCUIT

μ PC2260

LOW DROPOUT VOLTAGE REGULATOR WITH SYSTEM RESET PIN

DESCRIPTION

The μ PC2260 is a 500 mA maximum output current low dropout voltage regulator with a reset pin that outputs a reset signal when a drop in the output voltage is detected, and a reset signal output timing adjustment pin.

The output voltage is 5 V, and the minimum voltage difference between input and output is extremely low, making this product ideal for use in the power supply circuits of systems with built-in battery-driven microprocessors.

Because the reverse leakage current of this power supply is about 10 μ A even if a voltage is applied to the output pin when the input voltage is cut off, a reverse protection diode is not necessary even in systems requiring battery backup.

FEATURES

- Outputs reset signal (active low) when the output voltage drops.
- Power on reset constant can be set by attaching a single capacitor.
- Low minimum voltage difference between input and output
 $V_{DIF} = 0.5 \text{ V TYP. (when } I_o = 500 \text{ mA)}$
- Low reverse current leakage during back up
 $I_{OLK} = 10 \mu \text{ A MAX. (at } V_{IN} = 0 \text{ V, } V_o = 5 \text{ V, } 0^\circ\text{C} \leq T_J \leq 125^\circ\text{C)}$

PIN CONFIGURATION (Marking Side)

5-pin plastic V-DIP (V)
 μ PC2260V



- 1: INPUT
- 2: RESET
- 3: GND
- 4: DELAY CAPACITOR
- 5: OUTPUT

ORDERING INFORMATION

Part Number	Package
μ PC2260V	5-pin plastic V-DIP (V)

The information in this document is subject to change without notice. Before using this document, please confirm that this is the latest version.
 Not all devices/types available in every country. Please check with local NEC representative for availability and additional information.

BLOCK DIAGRAM

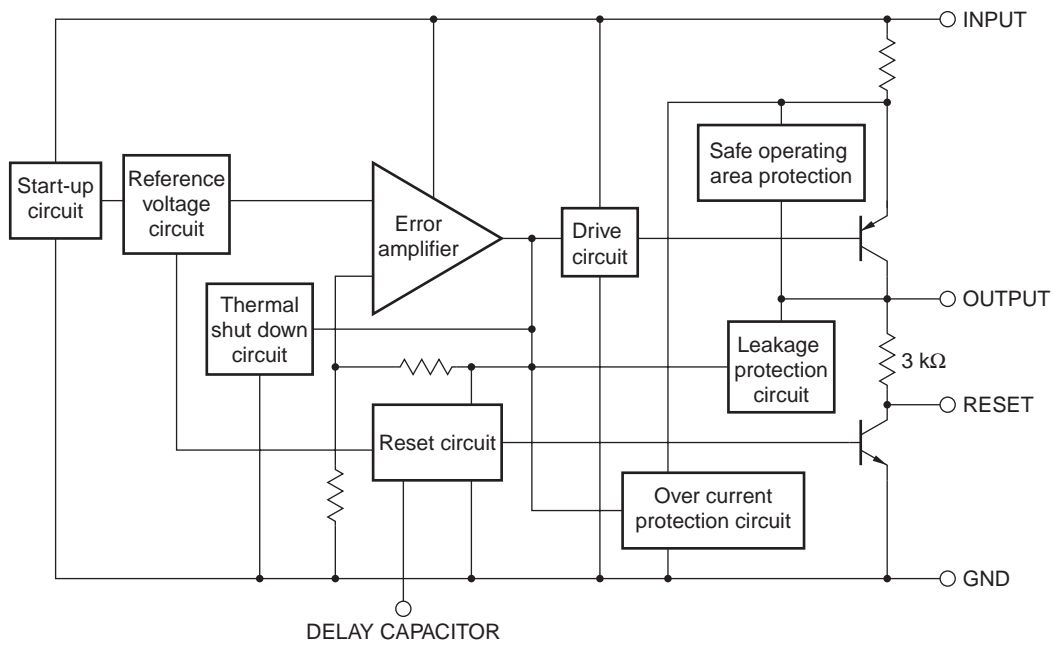

ABSOLUTE MAXIMUM RATINGS (T_A = +25 °C, unless otherwise specified.)

Parameter	Symbol	Ratings	Unit
Input Voltage	V _{IN}	-0.3 to +35	V
Reset Pin Applied Voltage	V _{RST}	-0.3 to +35	V
Total Power Dissipation (T _C = 25°C)	P _T	20 ^{Note}	W
Operating Ambient Temperature	T _A	-20 to +85	°C
Operating Junction Temperature	T _J	-20 to +150	°C
Storage Temperature	T _{stg}	-55 to +150	°C
Thermal Resistance (Junction to Case)	R _{th (J-C)}	4	°C/W
Thermal Resistance (Junction to Ambient Air)	R _{th (J-A)}	83	°C/W

Note The total loss is limited by an internal circuit. Where T_J > 150°C, an internal protection circuit cuts off the output.

Caution Product quality may suffer if the absolute maximum rating is exceeded even momentarily for any parameter. That is the absolute maximum ratings are rated values at which the product is on the verge of suffering physical damage, and therefore the product must be used under conditions that ensure that the absolute maximum ratings are not exceeded.

TYPICAL CONNECTION

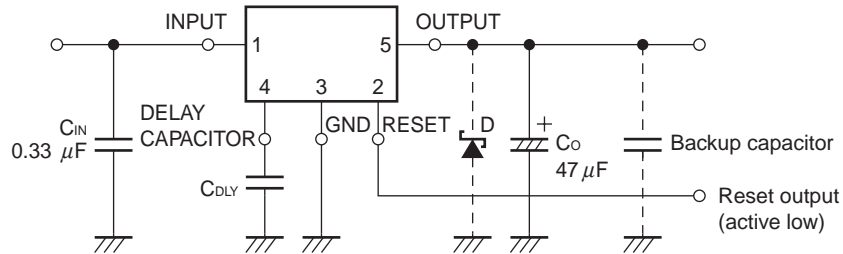

C_{IN} : 0.1 μF to 0.47 μF. Determine the capacitance depending on the line between the power supply smoothing circuit and input pin.

Be sure to connect this capacitor to prevent abnormal oscillation. Use of a capacitor, such as a film capacitor, with excellent voltage and temperature characteristics is recommended. Note that some laminated ceramic capacitors have poor temperature and voltage characteristics. When using a laminated ceramic capacitor, the capacitance must be stable in the voltage and temperature ranges used.

C_O : Must be 47 μF or more. Be sure to connect this capacitor to prevent oscillation and to improve transient load stability.

Connect C_{IN} and C_O as close to the IC (within 1 to 2 cm) as possible. When using this product below 0°C, select an electrolytic capacitor with low impedance characteristics.

D : Connect Schottky barrier diode (with a low forward voltage) if the voltage on the OUTPUT pin is lower than that on the GND pin.

RECOMMENDED OPERATING CONDITIONS

Parameter	Symbol	MIN.	TYP.	MAX.	Unit
Input Voltage	V _{IN}	6		20	V
Output Current	I _o	5		500	mA
Operating Junction Temperature	T _J	-20		+125	°C

Caution The recommended operating range may be exceeded without causing any problems provided that the absolute maximum ratings are not exceeded. However, if the device is operated in a way that exceeds the recommended operating conditions, the margin between the actual conditions of use and the absolute maximum ratings is small, and therefore thorough evaluation is necessary. The recommended operating conditions do not imply that the device can be used with all values at their maximum values.

ELECTRICAL CHARACTERISTICS

(T_J = 25 °C, V_{IN} = 9 V, I_o = 350 mA, C_{IN} = 0.33 μF, C_o = 47 μF, unless otherwise specified.)

Parameter	Symbol	Test Conditions	MIN.	TYP.	MAX.	Unit
Output Voltage	V _o		4.8	5.0	5.2	V
		6 V ≤ V _{IN} ≤ 20 V, 5 mA ≤ I _o ≤ 500 mA, 0 °C ≤ T _J ≤ 125 °C	4.75		5.25	V
Line Regulation	REG _{IN}	6.5 V ≤ V _{IN} ≤ 20 V		5	50	mV
Load Regulation	REG _L	5 mA ≤ I _o ≤ 500 mA		10	50	mV
Operating Circuit Current	I _{BIAS}	I _o = 0 A		2	5	mA
		I _o = 500 mA			30	mA
Operating Circuit Current Change	ΔI _{BIAS}	6.5 V ≤ V _{IN} ≤ 20 V, I _o = 500 mA			10	mA
Output Noise Voltage	V _n	10 Hz ≤ f ≤ 100 kHz		130		μV _{r.m.s.}
Ripple Rejection	R•R	f = 120 Hz, 6.5 V ≤ V _{IN} ≤ 16.5 V	56	65		dB
Dropout Voltage	V _{DIF}	I _o = 500 mA		0.5	0.8	V
Peak Output Current	I _{o peak}		0.7	0.95	1.2	A
Temperature Coefficient of Output Voltage	ΔV _o /ΔT	I _o = 5 mA, 0 °C ≤ T _J ≤ 125 °C		0.4		mV/°C
OFF Output Leakage Current	I _{OLK}	V _{IN} = 0 V, V _o = 5 V, 0 °C ≤ T _J ≤ 125 °C			10	μA
Reset Output Voltage (High Level)	V _{RSTH}	I _{RSTH} = 100 μA, 0 °C ≤ T _J ≤ 125 °C	V _o - 0.5			V
Reset Output Voltage (Low Level)	V _{RSTL}	Reset output is active (low level), I _{RSTL} = 1.6 mA, 0 °C ≤ T _J ≤ 125 °C		0.6	0.8	V
Reset Output Leakage Current	I _{RLK}	V _{o(RST)} ≤ V _o , 0 °C ≤ T _J ≤ 125 °C			10	μA
Output Voltage to Output Reset Signal	V _{o(RST)}	0 °C ≤ T _J ≤ 125 °C	V _o - 0.2		V _o - 0.1	V
Reset Output Delay Time	t _d	C _{DLY} = 0.1 μF, 0 °C ≤ T _J ≤ 125 °C		30		ms

RESET OUTPUT RESPONSE CHARACTERISTICS

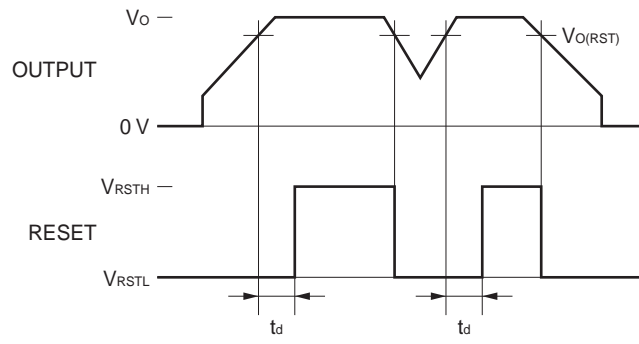

Remark $t_d = 30 \text{ ms TYP. at } C_{DLY} = 0.1 \mu\text{F}$

TYPICAL CHARACTERISTIC ($T_J = +25\text{ }^\circ\text{C}$, unless otherwise specified. Nominal)

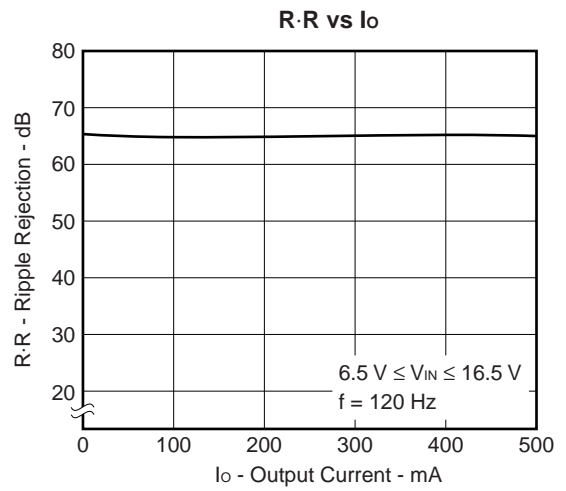
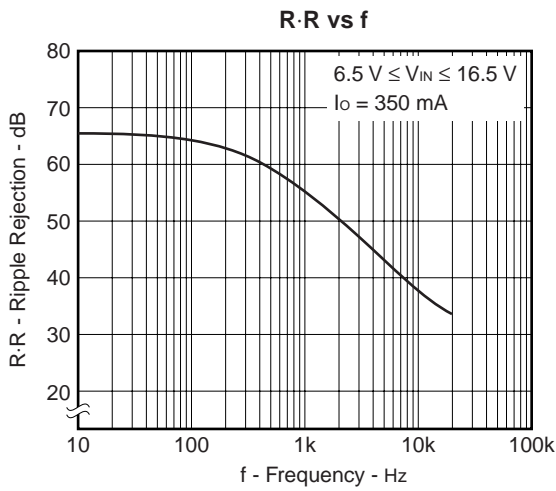
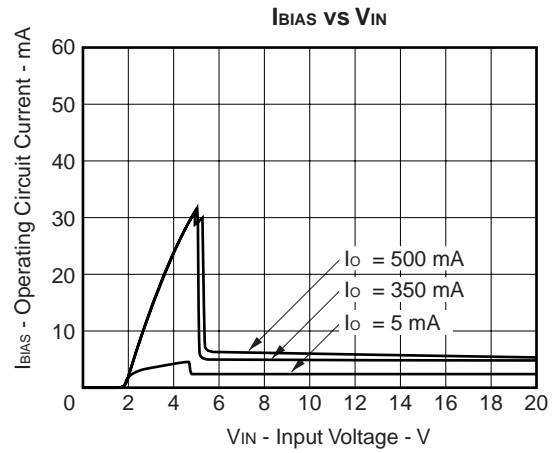
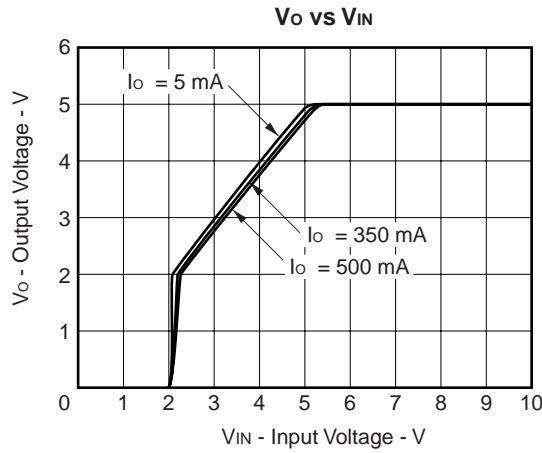
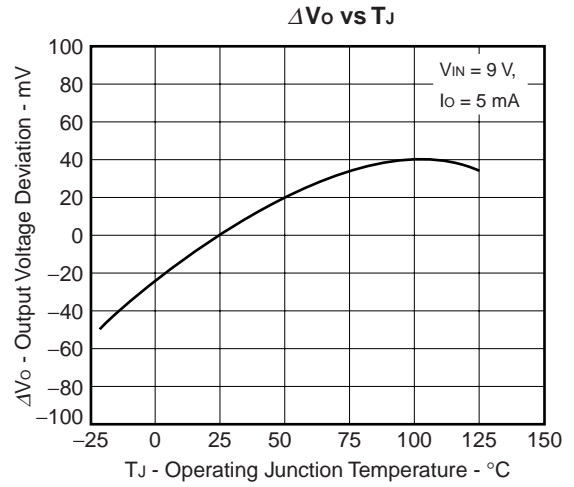
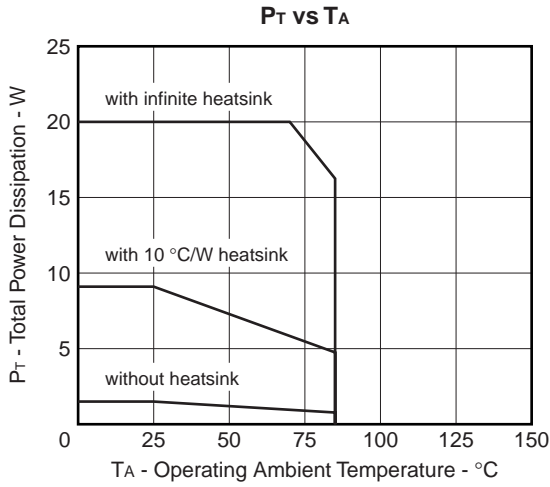

$I_{O\ peak}$ VS $(V_{IN} - V_O)$

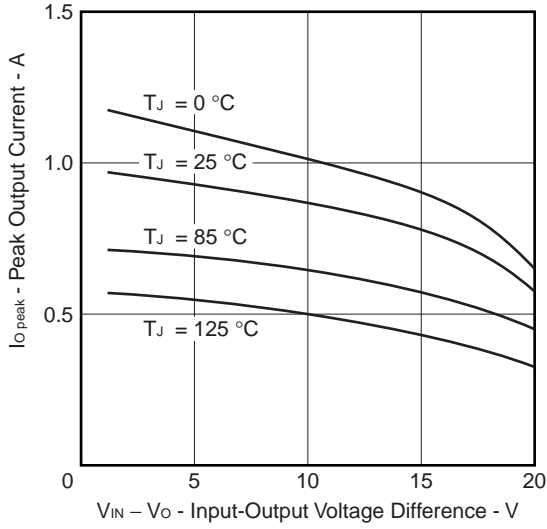

t_d VS C_{DLY}

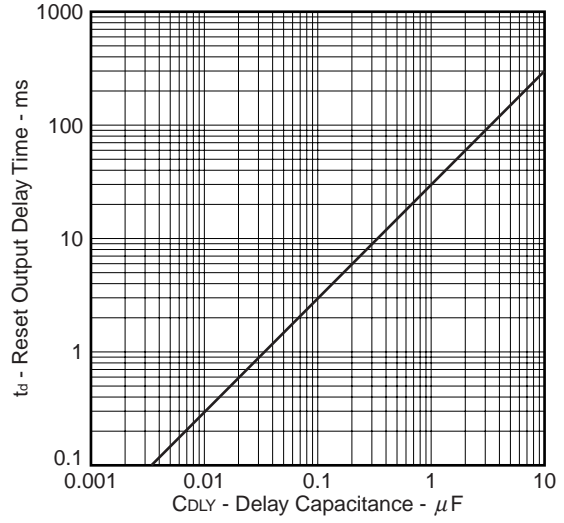

V_{RST} VS V_{IN}

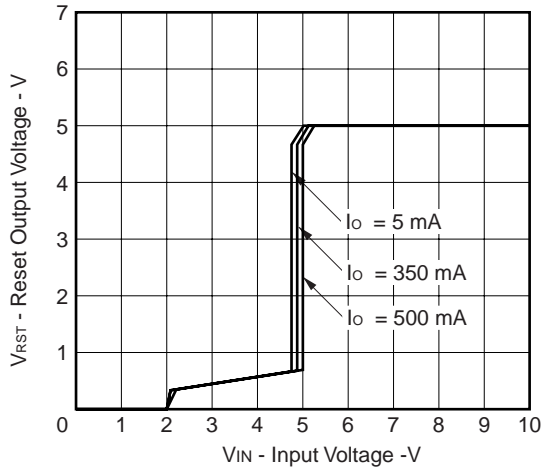

V_{RST} VS V_O

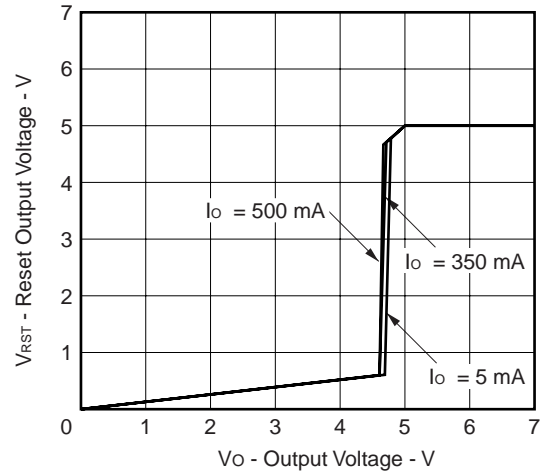

V_{RST} VS V_{IN} , V_{RST} VS V_O CHARACTERISTICS MEASUREMENT CIRCUIT

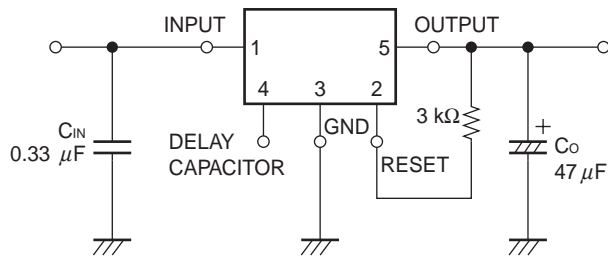

PACKAGE DRAWING

5-PIN PLASTIC V-DIP (V)

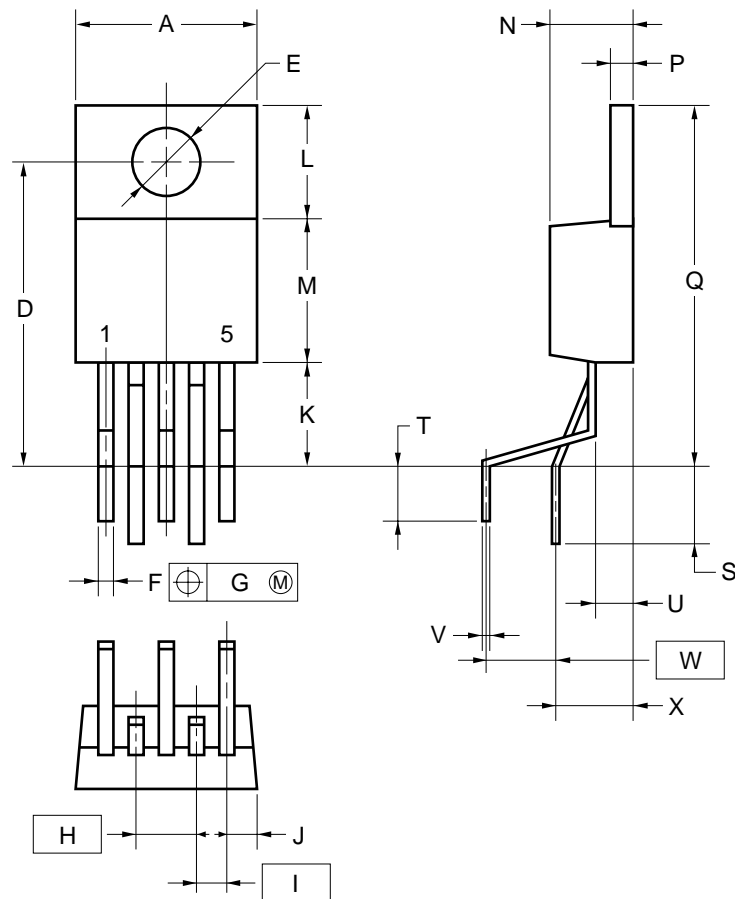

NOTE

Each lead centerline is located within 0.25 mm of its true position (T.P.) at maximum material condition.

ITEM	MILLIMETERS
A	10.4 MAX.
D	17.75±0.7
E	φ3.6±0.1
F	0.75±0.1
G	0.25
H	3.4
I	1.7
J	1.7 MAX.
K	5.0 MIN.
L	6.5
M	8.5
N	4.6±0.2
P	1.3±0.1
Q	21.15 MAX.
S	4.75±0.7
T	4.3±0.7
U	2.8±0.2
V	0.45±0.1
W	3.9
X	4.25±0.5

P5VP-340B3-3

RECOMMENDED SOLDERING CONDITIONS

When soldering this product, it is highly recommended to observe the conditions as shown below.

If other soldering processes are used, or if the soldering is performed under different conditions, please make sure to consult with our sales offices.

For more details, refer to our document “**Semiconductor Device Mounting Technology Manual**” (C10535E).

Type of Through-hole Device

μPC2260V : 5-pin plastic V-DIP (V)

Process	Conditions
Wave soldering (only to leads)	Solder temperature: 260°C or below, Flow time: 10 seconds or less.

Caution For through-hole device, the wave soldering process must be applied only to leads, and make sure that the package body does not get jet soldered.

[MEMO]

[MEMO]

- **The information in this document is current as of June, 2000. The information is subject to change without notice. For actual design-in, refer to the latest publications of NEC's data sheets or data books, etc., for the most up-to-date specifications of NEC semiconductor products. Not all products and/or types are available in every country. Please check with an NEC sales representative for availability and additional information.**
 - No part of this document may be copied or reproduced in any form or by any means without prior written consent of NEC. NEC assumes no responsibility for any errors that may appear in this document.
 - NEC does not assume any liability for infringement of patents, copyrights or other intellectual property rights of third parties by or arising from the use of NEC semiconductor products listed in this document or any other liability arising from the use of such products. No license, express, implied or otherwise, is granted under any patents, copyrights or other intellectual property rights of NEC or others.
 - Descriptions of circuits, software and other related information in this document are provided for illustrative purposes in semiconductor product operation and application examples. The incorporation of these circuits, software and information in the design of customer's equipment shall be done under the full responsibility of customer. NEC assumes no responsibility for any losses incurred by customers or third parties arising from the use of these circuits, software and information.
 - While NEC endeavours to enhance the quality, reliability and safety of NEC semiconductor products, customers agree and acknowledge that the possibility of defects thereof cannot be eliminated entirely. To minimize risks of damage to property or injury (including death) to persons arising from defects in NEC semiconductor products, customers must incorporate sufficient safety measures in their design, such as redundancy, fire-containment, and anti-failure features.
 - NEC semiconductor products are classified into the following three quality grades:
"Standard", "Special" and "Specific". The "Specific" quality grade applies only to semiconductor products developed based on a customer-designated "quality assurance program" for a specific application. The recommended applications of a semiconductor product depend on its quality grade, as indicated below. Customers must check the quality grade of each semiconductor product before using it in a particular application.
"Standard": Computers, office equipment, communications equipment, test and measurement equipment, audio and visual equipment, home electronic appliances, machine tools, personal electronic equipment and industrial robots
"Special": Transportation equipment (automobiles, trains, ships, etc.), traffic control systems, anti-disaster systems, anti-crime systems, safety equipment and medical equipment (not specifically designed for life support)
"Specific": Aircraft, aerospace equipment, submersible repeaters, nuclear reactor control systems, life support systems and medical equipment for life support, etc.
- The quality grade of NEC semiconductor products is "Standard" unless otherwise expressly specified in NEC's data sheets or data books, etc. If customers wish to use NEC semiconductor products in applications not intended by NEC, they must contact an NEC sales representative in advance to determine NEC's willingness to support a given application.
- (Note)
- (1) "NEC" as used in this statement means NEC Corporation and also includes its majority-owned subsidiaries.
(2) "NEC semiconductor products" means any semiconductor product developed or manufactured by or for NEC (as defined above).