

TGM-08-2002

Module Amplifier

2 GHz - 8 GHz

This Module Amplifier offers exceptional performance over the band 2 GHz to 8 GHz with 22.0 dBm P1dB output power and 9.5 dB Gain.

Teledyne Microwave amplifiers are balanced or feedback designs and manufactured with the latest MIC & MMIC technology. The GaAs FET's used in these amplifiers are well established proven devices from multiple sources.

Teledyne Microwave offers a complete line of Narrow and broadband Amplifiers covering the frequency range 500 MHz to 40 GHz. These products are available in either connectorized packages or as modules. For a complete list of these products and more, please visit our website.

Other products from Teledyne Microwave include: Transceivers, Synthesizers, and YIG Products



Specifications:

Model Number: TGM-08-2002
Frequency Range: 2 GHz – 8 GHz
Gain (min): 9.5 dB
Gain Vs Temp Coefficient per 1 deg C: -0.011 dB
Noise Figure (max): 6.5 dB
Output Power @ 1dB Compression: 22.0 dBm
Gain Flatness Vs Frequency: +/-0.5 dB
3rd Order Intercept (Typ): Contact Factory
Power Supply:
 Input Voltage: 11.5 to 15 VDC
 Current @ 12 VDC (typ): 200 mA
 Current @ 12 VDC (max): Contact Factory
Case Type (See attached Outline): 1006NP
Temperature Range: +25C



ISO 9001:2000

1274 Terra Bella Avenue, Mountain View, CA 94043 • PHN# 800.832.6869 or +1.650.962.6944 • FAX# 650.962.6845
www.teledynemicrowave.com • microwave@teledyne.com

TGM-08-2002

Module Amplifier

2 GHz - 8 GHz

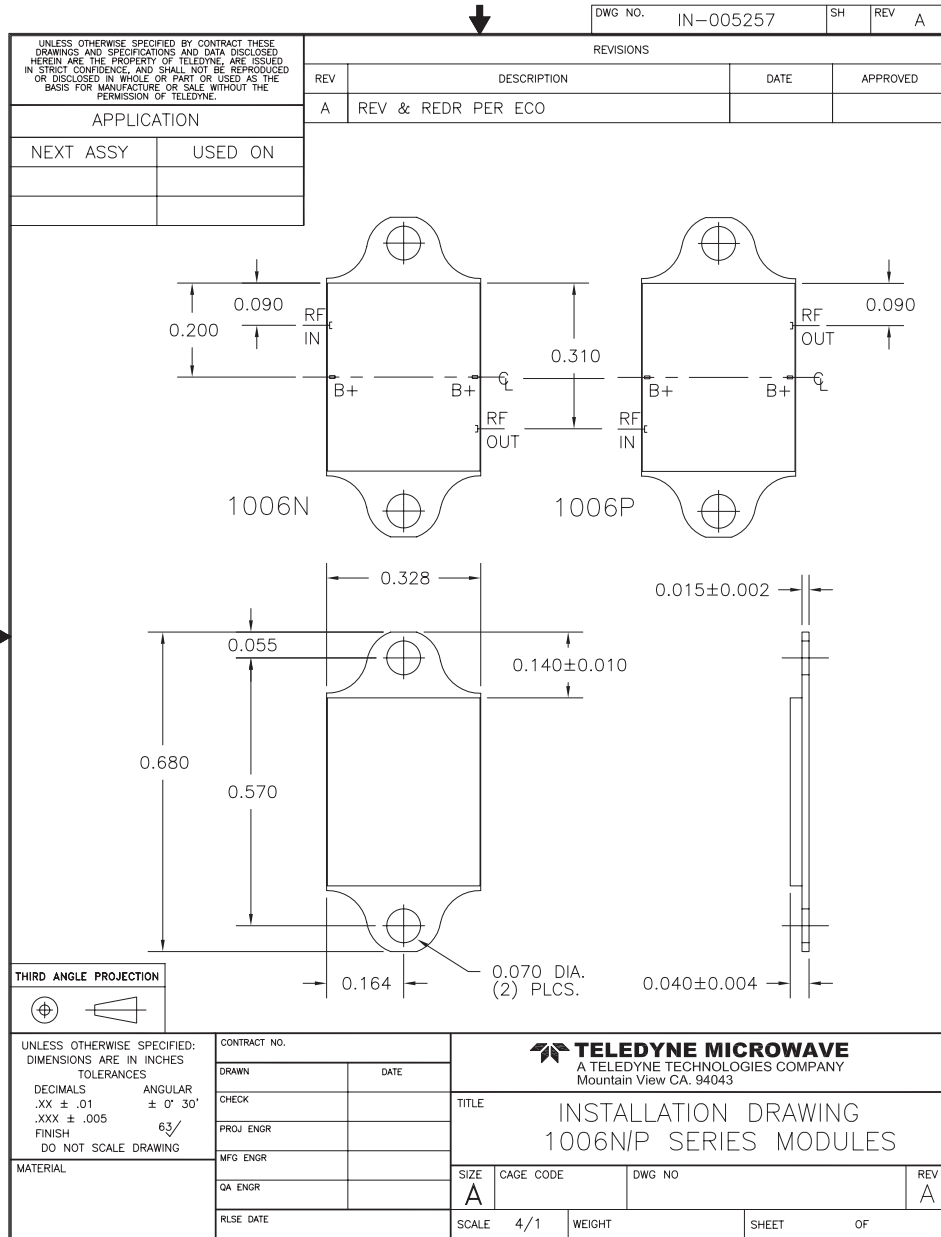

ISO 9001:2000

1274 Terra Bella Avenue, Mountain View, CA 94043 • PHN# 800.832.6869 or +1.650.962.6944 • FAX# 650.962.6845
 www.teledynemicrowave.com • microwave@teledyne.com