



# STPS80H100TV

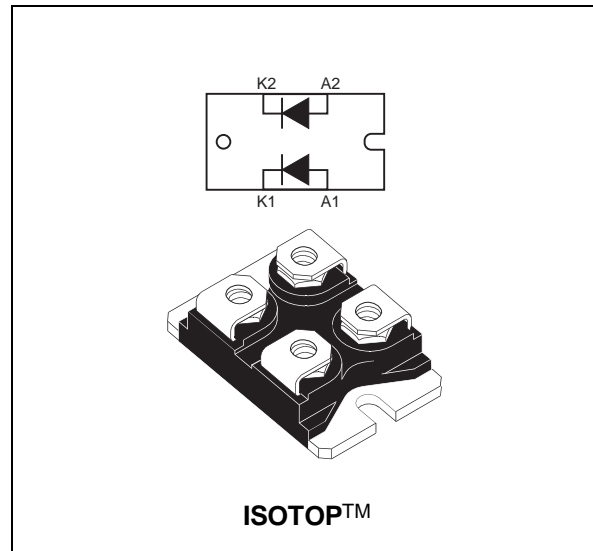
## HIGH VOLTAGE POWER SCHOTTKY RECTIFIER

### MAIN PRODUCT CHARACTERISTICS

<b>I<sub>F(AV)</sub></b>	<b>2 x 40 A</b>
<b>V<sub>RRM</sub></b>	<b>100 V</b>
<b>T<sub>j (max)</sub></b>	<b>150 °C</b>
<b>V<sub>F (max)</sub></b>	<b>0.65 V</b>

### FEATURES AND BENEFITS

- NEGLIGIBLE SWITCHING LOSSES
- HIGH JUNCTION TEMPERATURE CAPABILITY
- LOW LEAKAGE CURRENT
- GOOD TRADE OFF BETWEEN LEAKAGE CURRENT AND FORWARD VOLTAGE DROP
- AVALANCHE RATED
- LOW INDUCTANCE PACKAGE
- INSULATED PACKAGE :  
Insulated voltage = 2500 V<sub>(RMS)</sub>  
Capacitance = 45 pF



### DESCRIPTION

High voltage dual Schottky barrier rectifier designed for high frequency telecom and computer Switched Mode Power Supplies and other power converters.

Packaged in ISOTOP, this device is intended for use in medium voltage operation, and particularly, in high frequency circuitries where low switching losses and low noise are required.

### ABSOLUTE RATINGS (limiting values, per diode)

Symbol	Parameter		Value	Unit
V <sub>RRM</sub>	Repetitive peak reverse voltage		100	V
I <sub>F(RMS)</sub>	RMS forward current		125	A
I <sub>F(AV)</sub>	Average forward current	T <sub>c</sub> = 120°C δ = 0.5	Per diode 80	A
I <sub>FSM</sub>	Surge non repetitive forward current	t <sub>p</sub> = 10 ms sinusoidal	700	A
I <sub>RRM</sub>	Repetitive peak reverse current	t <sub>p</sub> = 2 μs square F = 1kHz	2	A
I <sub>RSM</sub>	Non repetitive peak reverse current	t <sub>p</sub> = 100 μs square	5	A
T <sub>stg</sub>	Storage temperature range		-55 to +150	°C
T <sub>j</sub>	Maximum operating junction temperature *		150	°C
dV/dt	Critical rate of rise of reverse voltage		10000	V/μs

\* :  $\frac{dP_{tot}}{dT_j} < \frac{1}{R_{th(j-a)}}$  thermal runaway condition for a diode on its own heatsink

# STPS80H100TV

## THERMAL RESISTANCES

Symbol	Parameter		Value	Unit
$R_{th(j-c)}$	Junction to case	Per leg	1	$^{\circ}\text{C}/\text{W}$
		Total	0.55	
$R_{th(c)}$		Coupling	0.1	

When the diodes 1 and 2 are used simultaneously :  
 $\Delta T_j(\text{diode } 1) = P(\text{diode } 1) \times R_{th(j-c)}(\text{Per diode}) + P(\text{diode } 2) \times R_{th(c)}$

## STATIC ELECTRICAL CHARACTERISTICS (per diode)

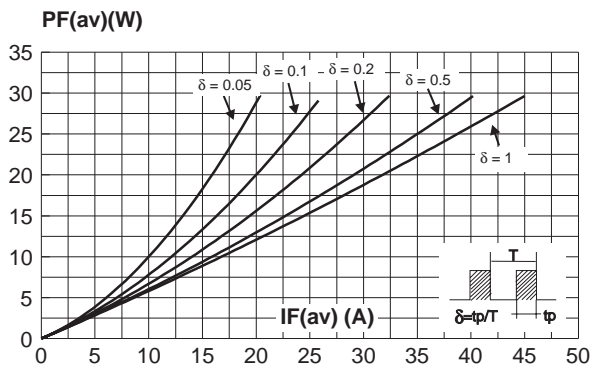
Symbol	Parameter	Tests Conditions		Min.	Typ.	Max.	Unit
$I_R^*$	Reverse leakage current	$T_j = 25^{\circ}\text{C}$	$V_R = V_{RRM}$			20	$\mu\text{A}$
		$T_j = 125^{\circ}\text{C}$			7	25	$\text{mA}$
$V_F^{**}$	Forward voltage drop	$T_j = 25^{\circ}\text{C}$	$I_F = 40 \text{ A}$			0.78	V
		$T_j = 125^{\circ}\text{C}$	$I_F = 40 \text{ A}$		0.61	0.65	
		$T_j = 25^{\circ}\text{C}$	$I_F = 80 \text{ A}$			0.89	
		$T_j = 125^{\circ}\text{C}$	$I_F = 80 \text{ A}$		0.7	0.74	

Pulse test : \*  $t_p = 5 \text{ ms}$ ,  $\delta < 2\%$   
 \*\*  $t_p = 380 \mu\text{s}$ ,  $\delta < 2\%$

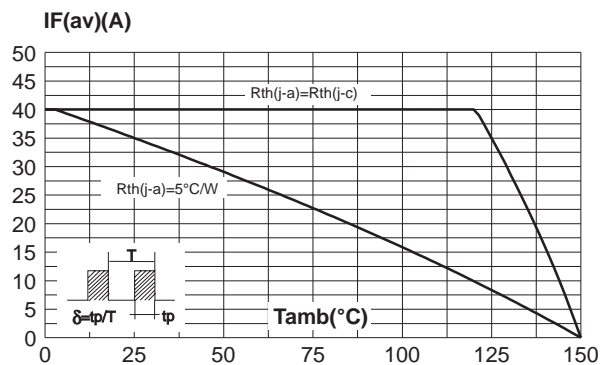
To evaluate the maximum conduction losses use the following equation :

$$P = 0.56 \times I_{F(AV)} + 0.0022 \times I_{F(RMS)}^2$$

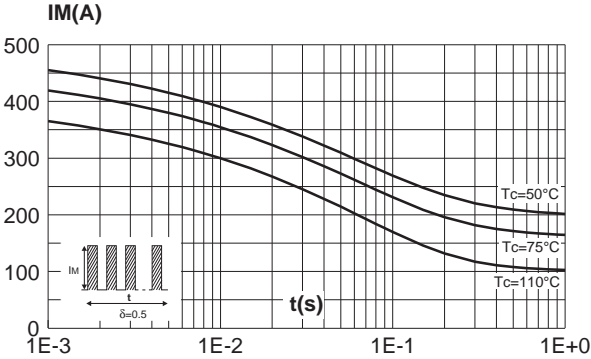
**Fig. 1:** Average forward power dissipation versus average forward current (per diode).



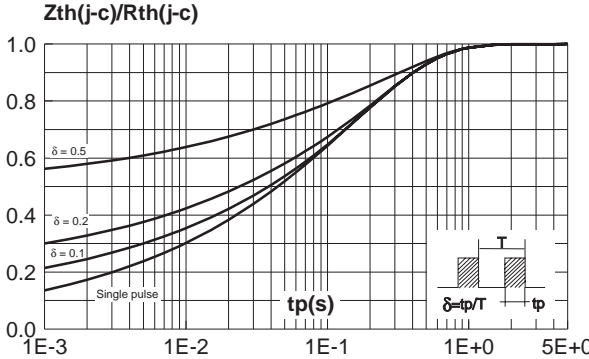
**Fig. 2:** Average forward current versus ambient temperature ( $\delta=0.5$ , per diode).



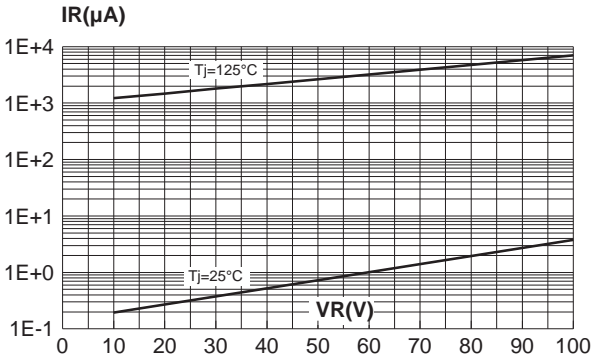
**Fig. 3:** Non repetitive surge peak forward current versus overload duration (maximum values, per diode).



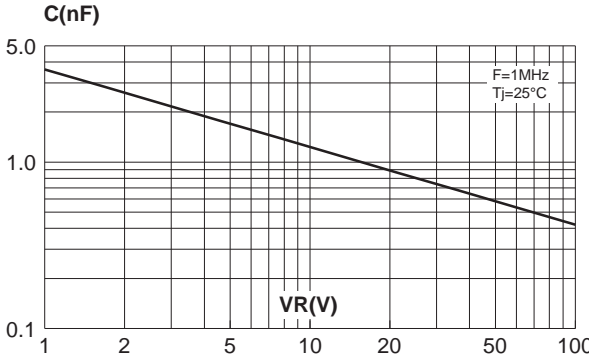
**Fig. 4:** Relative variation of thermal impedance junction to case versus pulse duration (per diode).



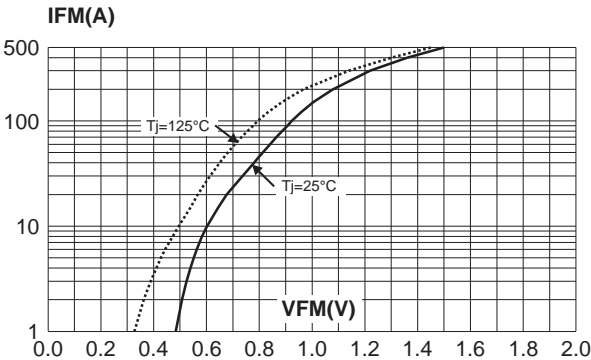
**Fig. 5:** Reverse leakage current versus reverse voltage applied (typical values, per diode).



**Fig. 6:** Junction capacitance versus reverse voltage applied (typical values, per diode).

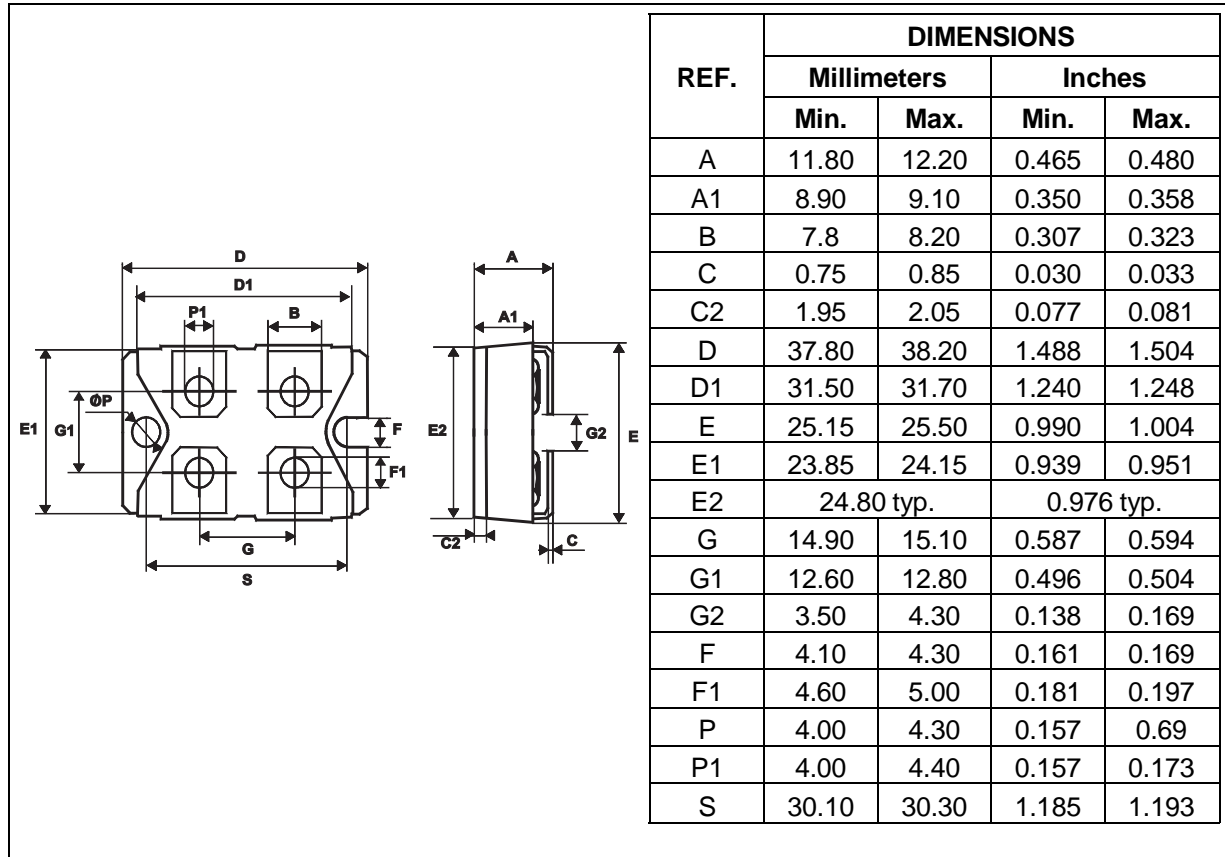


**Fig. 7:** Forward voltage drop versus forward current (maximum values, per diode).



# STPS80H100TV

## PACKAGE MECHANICAL DATA ISOTOP™



- Cooling method: C
- Recommended torque value: 1.3 N.m.
- Maximum torque value: 1.5 N.m.

Ordering type	Marking	Package	Weight	Base qty	Delivery mode
STPS80H100TV	STPS80H100TV	ISOTOP	27g without screws	10	Tube

- Epoxy meets UL94,V0

Information furnished is believed to be accurate and reliable. However, STMicroelectronics assumes no responsibility for the consequences of use of such information nor for any infringement of patents or other rights of third parties which may result from its use. No license is granted by implication or otherwise under any patent or patent rights of STMicroelectronics. Specifications mentioned in this publication are subject to change without notice. This publication supersedes and replaces all information previously supplied. STMicroelectronics products are not authorized for use as critical components in life support devices or systems without express written approval of STMicroelectronics.

The ST logo is a registered trademark of STMicroelectronics

© 1999 STMicroelectronics - Printed in Italy - All rights reserved.

STMicroelectronics GROUP OF COMPANIES

Australia - Brazil - China - Finland - France - Germany - Hong Kong - India - Italy - Japan - Malaysia  
Malta - Morocco - Singapore - Spain - Sweden - Switzerland - United Kingdom - U.S.A.

<http://www.st.com>