



# 8-BIT ADDRESSABLE LATCH

The SN54/74LS259 is a high-speed 8-Bit Addressable Latch designed for general purpose storage applications in digital systems. It is a multifunctional device capable of storing single line data in eight addressable latches, and also a 1-of-8 decoder and demultiplexer with active HIGH outputs. The device also incorporates an active LOW common Clear for resetting all latches, as well as, an active LOW Enable.

- Serial-to-Parallel Conversion
- Eight Bits of Storage With Output of Each Bit Available
- Random (Addressable) Data Entry
- Active High Demultiplexing or Decoding Capability
- Easily Expandable
- Common Clear

CONNECTION DIAGRAM DIP (TOP VIEW)

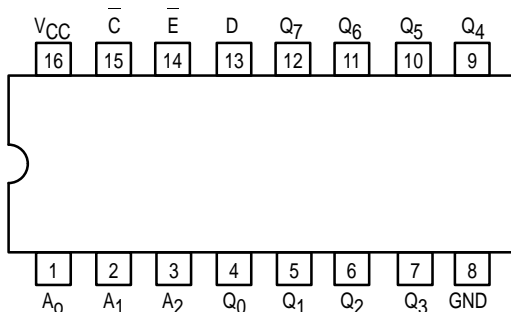

**PIN NAMES**

- A<sub>0</sub>, A<sub>1</sub>, A<sub>2</sub> Address Inputs
- D Data Input
- E Enable (Active LOW) Input
- C Clear (Active LOW) input
- Q<sub>0</sub> to Q<sub>7</sub> Parallel Latch Outputs (Note b)

**LOADING (Note a)**

	HIGH	LOW
A <sub>0</sub> , A <sub>1</sub> , A <sub>2</sub>	0.5 U.L.	0.25 U.L.
D	0.5 U.L.	0.25 U.L.
E	1.0 U.L.	0.5 U.L.
C	0.5 U.L.	0.25 U.L.
Q <sub>0</sub> to Q <sub>7</sub>	10 U.L.	5 (2.5) U.L.

**NOTES:**

- a) 1 TTL Unit Load (U.L.) = 40 μA HIGH/1.6 mA LOW.
- b) The Output LOW drive factor is 2.5 U.L. for Military (54) and 5 U.L. for Commercial (74) Temperature Ranges.

**GUARANTEED OPERATING RANGES**

Symbol	Parameter		Min	Typ	Max	Unit
V <sub>CC</sub>	Supply Voltage	54 74	4.5 4.75	5.0 5.0	5.5 5.25	V
T <sub>A</sub>	Operating Ambient Temperature Range	54 74	-55 0	25 25	125 70	°C
I <sub>OH</sub>	Output Current — High	54, 74			-0.4	mA
I <sub>OL</sub>	Output Current — Low	54 74			4.0 8.0	mA

## SN54/74LS259

### 8-BIT ADDRESSABLE LATCH LOW POWER SCHOTTKY

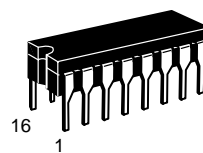

**J SUFFIX**  
CERAMIC  
CASE 620-09

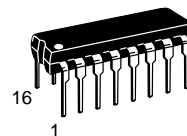

**N SUFFIX**  
PLASTIC  
CASE 648-08

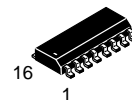

**D SUFFIX**  
SOIC  
CASE 751B-03

**ORDERING INFORMATION**

- SN54LSXXXJ Ceramic
- SN74LSXXXN Plastic
- SN74LSXXXD SOIC

# SN54/74LS259

## LOGIC DIAGRAM

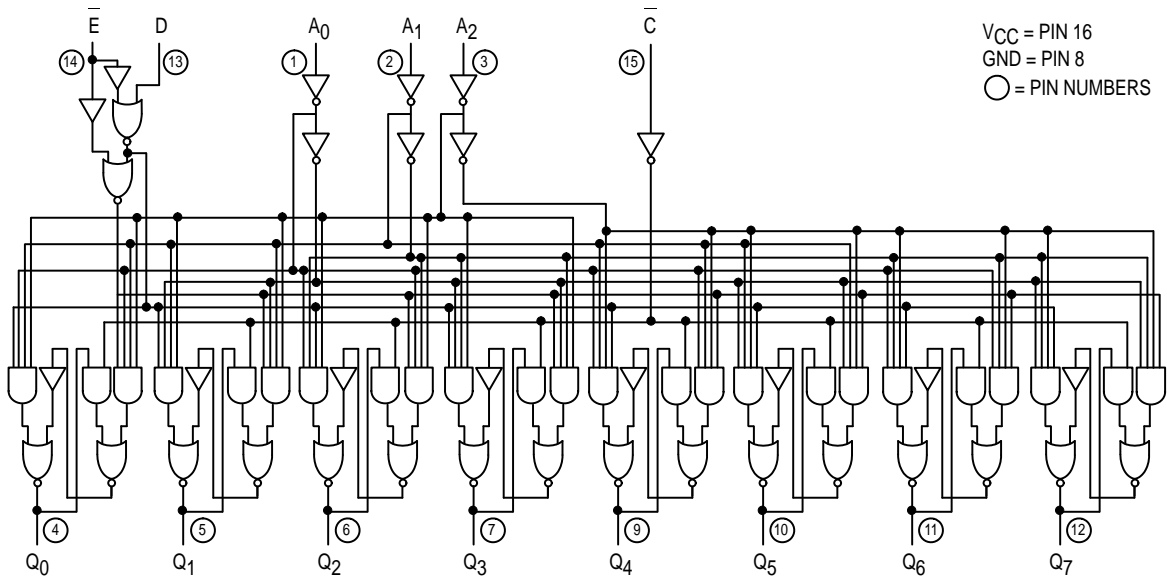

## FUNCTIONAL DESCRIPTION

The SN54/74LS259 has four modes of operation as shown in the mode selection table. In the addressable latch mode, data on the Data line (D) is written into the addressed latch. The addressed latch will follow the data input with all non-addressed latches remaining in their previous states. In the memory mode, all latches remain in their previous state and are unaffected by the Data or Address inputs.

In the one-of-eight decoding or demultiplexing mode, the

addressed output will follow the state of the D input with all other inputs in the LOW state. In the clear mode all outputs are LOW and unaffected by the address and data inputs.

When operating the SN54/74LS259 as an addressable latch, changing more than one bit of the address could impose a transient wrong address. Therefore, this should only be done while in the memory mode.

The truth table below summarizes the operations.

## MODE SELECTION

E	C	MODE
L	H	Addressable Latch
H	H	Memory
L	L	Active HIGH Eight-Channel Demultiplexer
H	L	Clear

## TRUTH TABLE PRESENT OUTPUT STATES

C	E	D	A <sub>0</sub>	A <sub>1</sub>	A <sub>2</sub>	Q <sub>0</sub>	Q <sub>1</sub>	Q <sub>2</sub>	Q <sub>3</sub>	Q <sub>4</sub>	Q <sub>5</sub>	Q <sub>6</sub>	Q <sub>7</sub>	MODE
L	H	X	X	X	X	L	L	L	L	L	L	L	L	Clear Demultiplex
L	L	L	L	L	L	L	L	L	L	L	L	L	L	
L	L	H	L	L	L	H	L	L	L	L	L	L	L	Memory
L	L	L	H	L	L	L	L	L	L	L	L	L	L	
L	L	H	H	L	L	L	H	L	L	L	L	L	L	
•	•	•	•	•	•	•	•	•	•	•	•	•	•	
•	•	•	•	•	•	•	•	•	•	•	•	•	•	
•	•	•	•	•	•	•	•	•	•	•	•	•	•	
•	•	•	•	•	•	•	•	•	•	•	•	•	•	
•	•	•	•	•	•	•	•	•	•	•	•	•	•	
L	L	H	H	H	H	L	L	L	L	L	L	L	H	
H	H	X	X	X	X	Q <sub>N-1</sub>	→						Memory	
H	L	L	L	L	L	L	Q <sub>N-1</sub>	Q <sub>N-1</sub>	Q <sub>N-1</sub>	→			Addressable Latch	
H	L	H	L	L	L	H	Q <sub>N-1</sub>	Q <sub>N-1</sub>	Q <sub>N-1</sub>	→				
H	L	L	H	L	L	Q <sub>N-1</sub>	L	Q <sub>N-1</sub>	Q <sub>N-1</sub>	→				
H	L	H	H	L	L	Q <sub>N-1</sub>	H	Q <sub>N-1</sub>	Q <sub>N-1</sub>	→				
•	•	•	•	•	•	•	•	•	•	•				
H	L	L	H	H	H	Q <sub>N-1</sub>	→					Q <sub>N-1</sub>	L	
H	L	H	H	H	H	Q <sub>N-1</sub>	→					Q <sub>N-1</sub>	H	

X = Don't Care Condition  
L = LOW Voltage Level  
H = HIGH Voltage Level  
Q<sub>N-1</sub> = Previous Output State

# SN54/74LS259

## DC CHARACTERISTICS OVER OPERATING TEMPERATURE RANGE (unless otherwise specified)

Symbol	Parameter		Limits			Unit	Test Conditions
			Min	Typ	Max		
V <sub>IH</sub>	Input HIGH Voltage		2.0			V	Guaranteed Input HIGH Voltage for All Inputs
V <sub>IL</sub>	Input LOW Voltage	54			0.7	V	Guaranteed Input LOW Voltage for All Inputs
		74			0.8		
V <sub>IK</sub>	Input Clamp Diode Voltage			-0.65	-1.5	V	V <sub>CC</sub> = MIN, I <sub>IN</sub> = -18 mA
V <sub>OH</sub>	Output HIGH Voltage	54	2.5	3.5		V	V <sub>CC</sub> = MIN, I <sub>OH</sub> = MAX, V <sub>IN</sub> = V <sub>IH</sub> or V <sub>IL</sub> per Truth Table
		74	2.7	3.5		V	
V <sub>OL</sub>	Output LOW Voltage	54, 74		0.25	0.4	V	I <sub>OL</sub> = 4.0 mA V <sub>CC</sub> = V <sub>CC</sub> MIN, V <sub>IN</sub> = V <sub>IL</sub> or V <sub>IH</sub> per Truth Table
		74		0.35	0.5	V	
I <sub>IH</sub>	Input HIGH Current				20	μA	V <sub>CC</sub> = MAX, V <sub>IN</sub> = 2.7 V
					0.1	mA	V <sub>CC</sub> = MAX, V <sub>IN</sub> = 7.0 V
I <sub>IL</sub>	Input LOW Current				-0.4	mA	V <sub>CC</sub> = MAX, V <sub>IN</sub> = 0.4 V
I <sub>OS</sub>	Short Circuit Current (Note 1)		-20		-100	mA	V <sub>CC</sub> = MAX
I <sub>CC</sub>	Power Supply Current				36	mA	V <sub>CC</sub> = MAX

Note 1: Not more than one output should be shorted at a time, nor for more than 1 second.

## AC CHARACTERISTICS (T<sub>A</sub> = 25°C, V<sub>CC</sub> = 5.0 V)

Symbol	Parameter		Limits			Unit	Test Conditions
			Min	Typ	Max		
t <sub>PLH</sub>	Turn-Off Delay, Enable to Output			22	35	ns	C <sub>L</sub> = 15 pF
t <sub>PHL</sub>	Turn-On Delay, Enable to Output			15	24	ns	
t <sub>PLH</sub>	Turn-Off Delay, Data to Output			20	32	ns	
t <sub>PHL</sub>	Turn-On Delay, Data to Output			13	21	ns	
t <sub>PLH</sub>	Turn-Off Delay, Address to Output			24	38	ns	
t <sub>PHL</sub>	Turn-On Delay, Address to Output			18	29	ns	
t <sub>PHL</sub>	Turn-On Delay, Clear to Output			17	27	ns	

## AC SET-UP REQUIREMENTS (T<sub>A</sub> = 25°C, V<sub>CC</sub> = 5.0 V)

Symbol	Parameter		Limits			Unit
			Min	Typ	Max	
t <sub>s</sub>	Input Setup Time		20			ns
t <sub>w</sub>	Pulse Width, Clear or Enable		15			ns
t <sub>h</sub>	Hold Time, Data		5.0			ns
t <sub>h</sub>	Hold Time, Address		20			ns

# SN54/74LS259

## AC WAVEFORMS

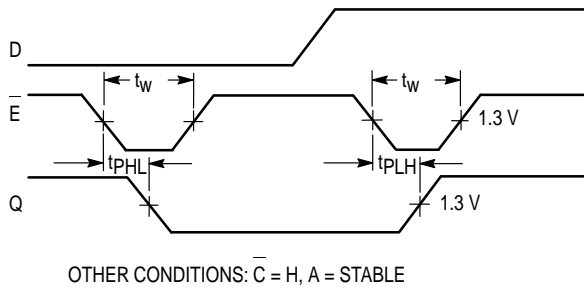

**Figure 1. Turn-on and Turn-off Delays, Enable To Output and Enable Pulse Width**

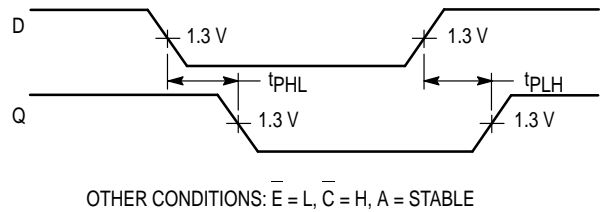

**Figure 2. Turn-on and Turn-off Delays, Data to Output**

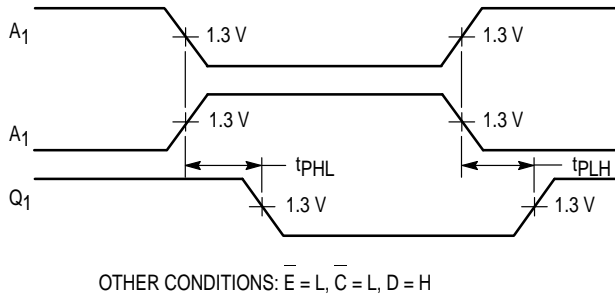

**Figure 3. Turn-on and Turn-off Delays, Address to Output**

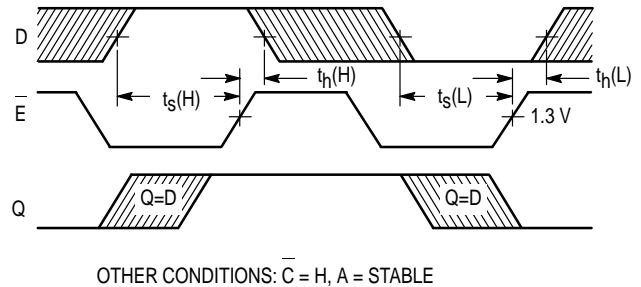

**Figure 4. Setup and Hold Time, Data to Enable**

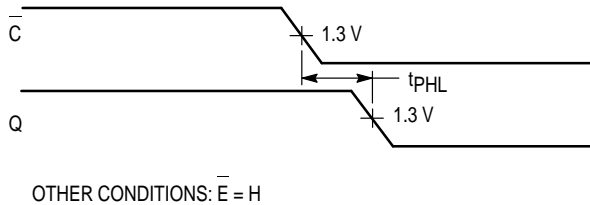

**Figure 5. Turn-on Delay, Clear to Output**

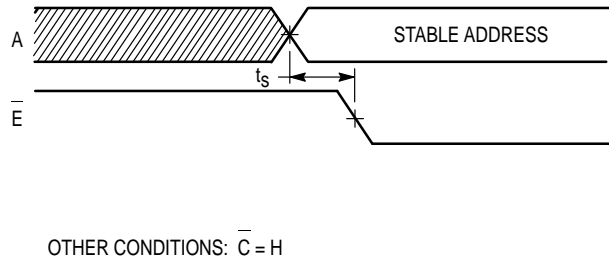

**Figure 6. Setup Time, Address to Enable (See Notes 1 and 2)**

**NOTES:**

1. The Address to Enable Setup Time is the time before the HIGH-to-LOW Enable transition that the Address must be stable so that the correct latch is addressed and the other latches are not affected.
2. The shaded areas indicate when the inputs are permitted to change for predictable output performance.