

OM100Q05CB/RB/DB OM100Q15CB/RB/DB OM100Q30CB/RB/DB OM100Q50CB/RB/DB OM100Q70CB/RB/DB
 OM100Q10CB/RB/DB OM100Q20CB/RB/DB OM100Q40CB/RB/DB OM100Q60CB/RB/DB OM100Q80CB/RB/DB

100 AMP ULTRA FAST CENTER-TAP IN HERMETIC ISOLATED POWER BLOCK PACKAGE

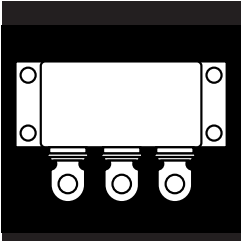

100 Amp, 50 To 800 Volt High Power Rectifier Module

FEATURES

- Rugged Package Design
- Very Low Forward Voltage
- Very Fast Switching Time
- High Current
- Center-Tap Configuration
- Low Thermal Resistance
- Common Cathode Standard
- Ceramic Feedthroughs Available
- Available Screened To MIL-S-19500, TX, TXV And S Levels

DESCRIPTION

This series of products in a hermetic package is specifically designed for use at power switching frequencies in excess of 100 kHz. The series combines the latest silicon technology and a package specifically designed for high efficiency/high current applications. These devices are ideally suited for applications where small size and a hermetically sealed package are required.

ABSOLUTE MAXIMUM RATINGS (Per Diode) @ 25°C

Peak Inverse Voltage	50 to 800 V
Maximum Average D.C. Output Current @ $T_C = 100^\circ\text{C}$	50 A
Surge Current (Non-Repetitive 8.3 ms)	700 A
Thermal Resistance, Junction-to-Case	1.0°C/W
Operating and Storage Temperature Range	- 55° C to + 150°C

3.2

SCHEMATIC

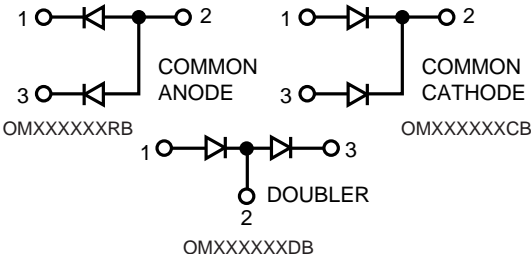

PIN CONNECTION

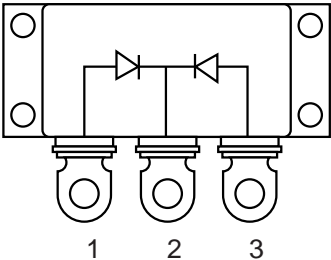

Common cathode is standard. Contact factory for performance characteristics for common anode and doubler.

OM100Q05CB/RB/DB - OM100Q80CB/RB/DB

ELECTRICAL CHARACTERISTICS (Per Diode)

Part Number	PIV	Maximum Forward Voltage $I_F = 50 \text{ A}^{(1)}$		Maximum Reverse Current @ PIV		Maximum Reverse Recovery Time (2)
		$T_J = 25^\circ \text{ C}$	$T_J = 100^\circ \text{ C}$	$T_J = 25^\circ \text{ C}$	$T_J = 100^\circ \text{ C}$	
OM100Q05XX	50 V	.97 V	.85 V	25 μA	3.0 mA	50 ns
OM100Q10XX	100 V					
OM100Q15XX	150 V					
OM100Q20XX	200 V					
OM100Q30XX	300 V	1.20 V	1.00 V			
OM100Q40XX	400 V					
OM100Q50XX	500 V					
OM100Q60XX	600 V	1.30 V	1.05 V	100 ns		
OM100Q70XX	700 V					
OM100Q80XX	800 V					

Notes: (1) Pulse Test: Pulse Width = 300 μs , Duty Cycle = 2.0%. (2) Measured in Circuit: $I_F = 0.5 \text{ A}$, $I_R = 1.0 \text{ A}$, $I_{REC} = 0.25 \text{ A}$

Typical Forward Voltage

50V - 200V

300V - 500V

600V - 800V

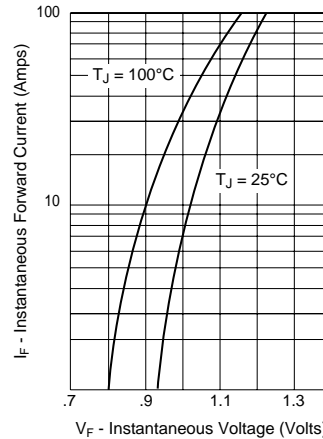
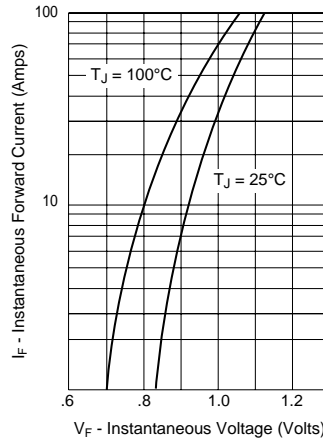
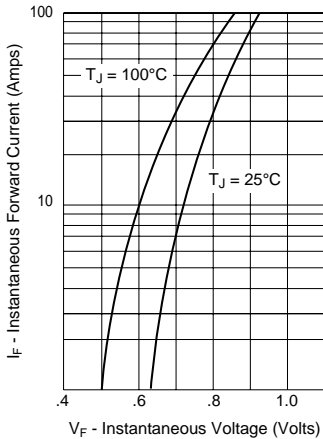

Typical Reverse Current

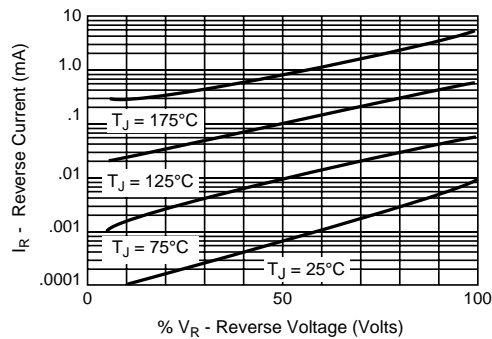

Mechanical Outline

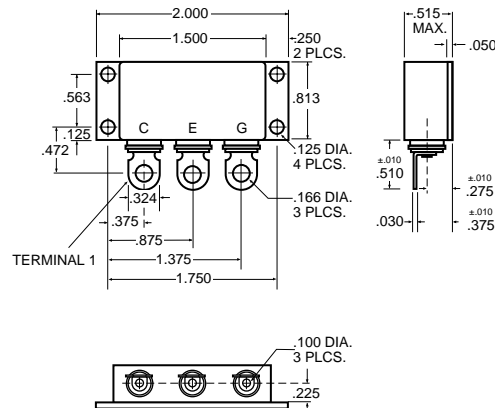

3.2