

EE-SH3 Series

Photomicrosensor (Transmissive)

■ Dimensions

Note: All units are in millimeters unless otherwise indicated.

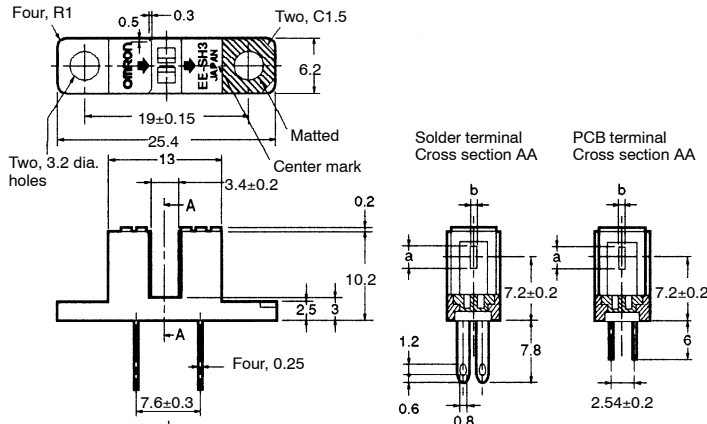

Model	Aperture (a x b)
EE-SH3(-B)	2.1 x 0.5
EE-SH3-C(S)	2.1 x 1.0
EE-SH3-D(S)	2.1 x 0.2
EE-SH3-G(S)	0.5 x 2.1

Internal Circuit

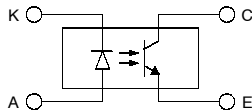

Unless otherwise specified, the tolerances are as shown below.

Dimensions	Tolerance
3 mm max.	±0.2
3 < mm ≤ 6	±0.24
6 < mm ≤ 10	±0.29
10 < mm ≤ 18	±0.35
18 < mm ≤ 30	±0.42

Terminal No.	Name
A	Anode
K	Cathode
C	Collector
E	Emitter

■ Features

- All models have 3.4 mm wide slot.
- Solder terminal models:
EE-SH3/-SH3-CS/-SH3-DS/-SH3-GS
- PCB terminal models:
EE-SH3-B/-SH3-C/-SH3-D/-SH3-G

■ Absolute Maximum Ratings (Ta = 25°C)

Item	Symbol	Rated value
Emitter	Forward current	I _F 50 mA (see note 1)
	Pulse forward current	I _{FP} 1 A (see note 2)
	Reverse voltage	V _R 4 V
Detector	Collector-Emitter voltage	V _{CEO} 30 V
	Emitter-Collector voltage	V _{ECO} ---
	Collector current	I _C 20 mA
	Collector dissipation	P _C 100 mW (see note 1)
Ambient temperature	Operating	T _{opr} -25°C to 85°C
	Storage	T _{stg} -30°C to 100°C
Soldering temperature	T _{sol}	260°C (see note 3)

- Note:**
1. Refer to the temperature rating chart if the ambient temperature exceeds 25°C.
 2. The pulse width is 10 μs maximum with a frequency of 100 Hz.
 3. Complete soldering within 10 seconds.

■ Ordering Information

Description	Part number
Photomicrosensor (Transmissive)	EE-SH3(-B)
	EE-SH3-C(S)
	EE-SH3-D(S)
	EE-SH3-G(S)

■ Electrical and Optical Characteristics (Ta = 25°C)

Item	Symbol	Value				Condition
		EE-SH3(-B)	EE-SH3-C(S)	EE-SH3-D(S)	EE-SH3-G(S)	
Emitter	Forward voltage	V _F	1.2 V typ., 1.5 V max.			I _F = 30 mA
	Reverse current	I _R	0.01 μA typ., 10 μA max.			V _R = 4 V
	Peak emission wavelength	λ _P	940 nm typ.			I _F = 20 mA
Detector	Light current	I _L	0.5 to 14 mA typ.	1 to 28 mA typ.	0.1 mA min. 0.5 to 14 mA	I _F = 20 mA, V _{CE} = 10 V
	Dark current	I _D	2 nA typ., 200 nA max.			V _{CE} = 10 V, 0 lx
	Leakage current	I _{LEAK}	---			---
	Collector-Emitter saturated voltage	V _{CE (sat)}	0.1 V typ., 0.4 V max.		---	0.1 V typ., 0.4 V max. I _F = 20 mA, I _L = 0.1 mA
Peak spectral sensitivity wavelength	λ _P	850 nm typ.			V _{CE} = 10 V	
Rising time	t _r	4 μs typ.			V _{CC} = 5 V, R _L = 100 Ω, I _L = 5 mA	
Falling time	t _f	4 μs typ.				

Engineering Data

Forward Current vs. Collector Dissipation Temperature Rating

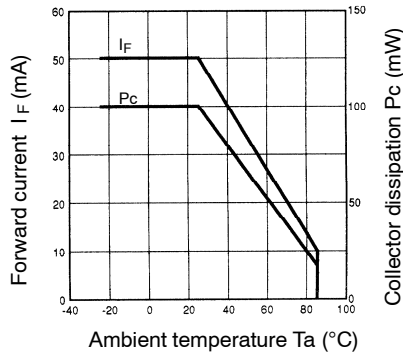

Forward Current vs. Forward Voltage Characteristics (Typical)

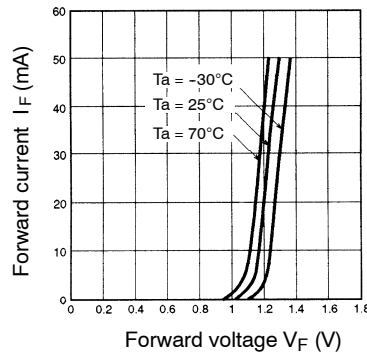

Light Current vs. Forward Current Characteristics (Typical)

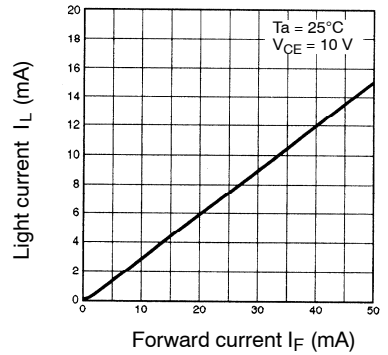

Light Current vs. Collector-Emitter Voltage Characteristics (EE-SH3(B))

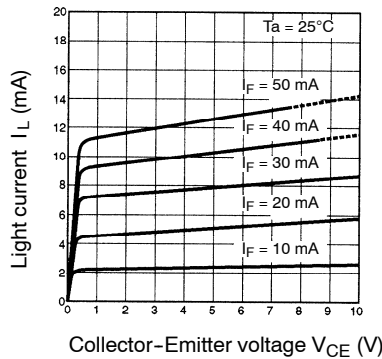

Relative Light Current vs. Ambient Temperature Characteristics (Typical)

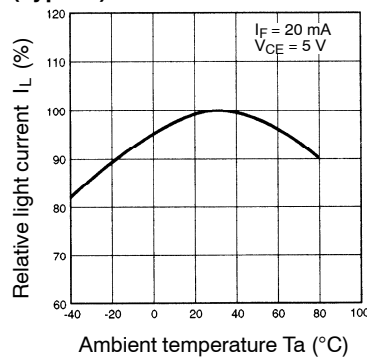

Dark Current vs. Ambient Temperature Characteristics (Typical)

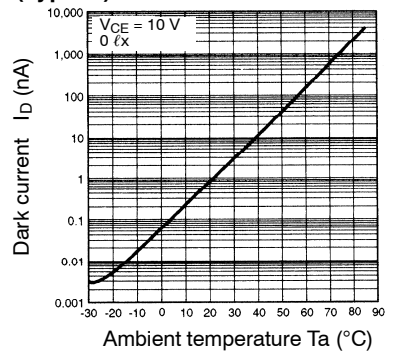

Response Time vs. Load Resistance Characteristics (Typical)

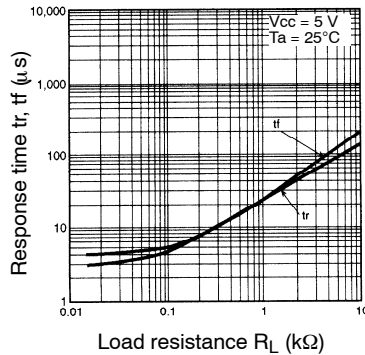

Sensing Position Characteristics (EE-SH3-D(S))

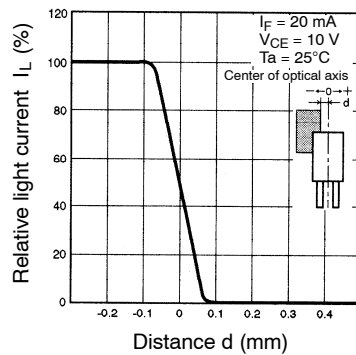

Sensing Position Characteristics (EE-SH3(B))

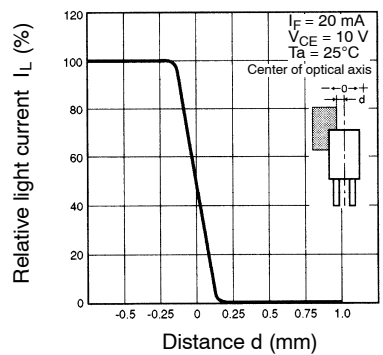

Sensing Position Characteristics (EE-SH3-G(S))

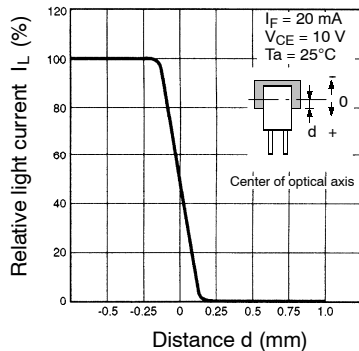

Sensing Position Characteristics (EE-SH3-C(S))

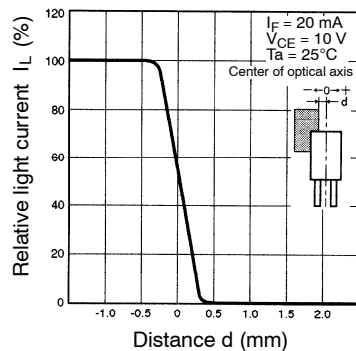

Response Time Measurement Circuit

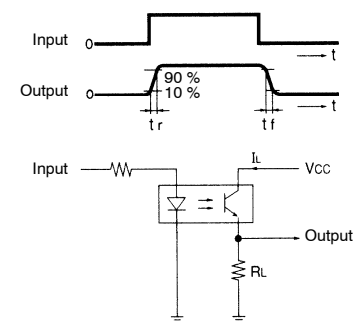

NOTE: DIMENSIONS SHOWN ARE IN MILLIMETERS. To convert millimeters to inches divide by 25.4.

OMRON[®]

OMRON ELECTRONICS LLC

One East Commerce Drive
Schaumburg, IL 60173

847-882-2288

OMRON CANADA, INC.

885 Milner Avenue
Toronto, Ontario M1B 5V8

416-286-6465

OMRON ON-LINE

Global – <http://www.omron.com>

USA – <http://www.omron.com/oei>

Canada – <http://www.omron.com/oci>