

SANYO

No.688G

2SB827/2SD1063

PNP/NPN Epitaxial Planar Silicon Transistors

50V/7A Switching Applications

Use : Universal high current switching as solenoid driving, high speed inverter and converter.

Features :

- . Low saturation voltage : $V_{CE(sat)} = (-)0.4V$ max.
- . Wide ASO.

() shows the case of 2SB827 only.

Absolute Maximum Ratings at $T_a = 25^\circ C$

Collector-to-Base Voltage	V_{CBO}	(-)60	V
Collector-to-Emitter Voltage	V_{CEO}	(-)50	V
Emitter-to-Base Voltage	V_{EBO}	(-)6	V
Collector Current	I_C	(-)7	A
Collector Current(Pulse)	I_{CP}	(-)14	A
Collector Dissipation	P_C	$T_C = 25^\circ C$	60 W
Junction Temperature	T_j	150	$^\circ C$
Storage Temperature	T_{stg}	-55 to +150	$^\circ C$

Electrical Characteristics at $T_a = 25^\circ C$

			min	typ	max	unit
Collector Cut off Current	I_{CBO}	$V_{CB} = (-)40V, I_E = 0$			(-)0.1	mA
Emitter Cut off Current	I_{EBO}	$V_{EB} = (-)4V, I_C = 0$			(-)0.1	mA
DC Current Gain	$h_{FE}(1)$	$V_{CE} = (-)2V, I_C = (-)1A$	70*		280*	
	$h_{FE}(2)$	$V_{CE} = (-)2V, I_C = (-)5A$	30			
Gain Bandwidth Product	f_T	$V_{CE} = (-)5V, I_C = (-)1A$		10		MHz
C-E Saturation Voltage	$V_{CE(sat)}$	$I_C = (-)4A, I_B = (-)0.4A$			(-)0.4	V
C-B Breakdown Voltage	$V_{(BR)CBO}$	$I_C = (-)1mA, I_E = 0$	(-)60			V
C-E Breakdown Voltage	$V_{(BR)CEO}$	$I_C = (-)1mA, R_{BE} = \infty$	(-)50			V
E-B Breakdown Voltage	$V_{(BR)EBO}$	$I_E = (-)1mA, I_C = 0$	(-)6			V
Turn-on Time	t_{on}	At the test circuit		0.2		μs
Fall Time	t_f	At the test circuit	(0.1)0.3			μs
Storage Time	t_{stg}	At the test circuit	(0.7)0.9			μs

*:The 2SB827/2SD1063 are classified by $1A h_{FE}$ as follows:

70	Q	140	100	R	200	140	S	280
----	---	-----	-----	---	-----	-----	---	-----

Switching Time Test Circuit

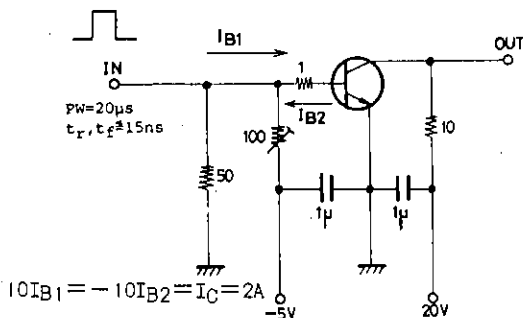

(For PNP, the porality is reversed.)

Unit (Resistance : Ω , Capacitance : F)

Package Dimensions 2022
(unit:mm)

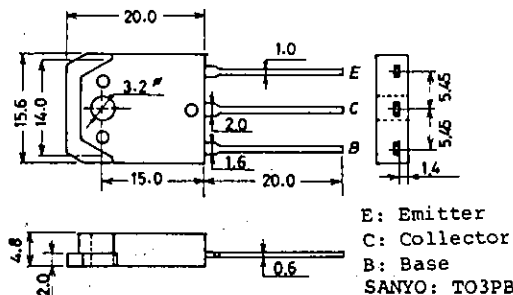

E: Emitter
C: Collector
B: Base
SANYO: TO3PB

SANYO Electric Co., Ltd. Semiconductor Business Headquarters
TOKYO OFFICE Tokyo Bldg., 1-10, 1 Chome, Ueno, Taito-ku, TOKYO, 110 JAPAN

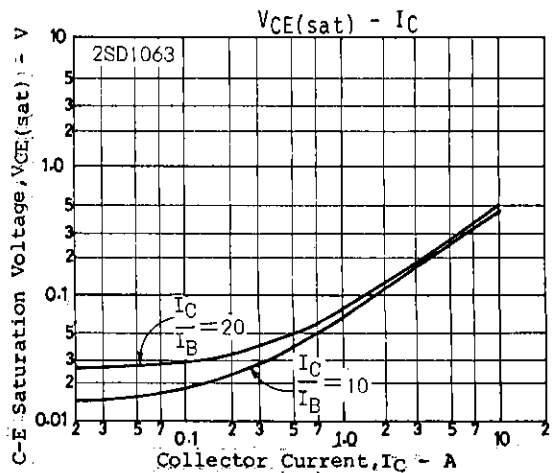
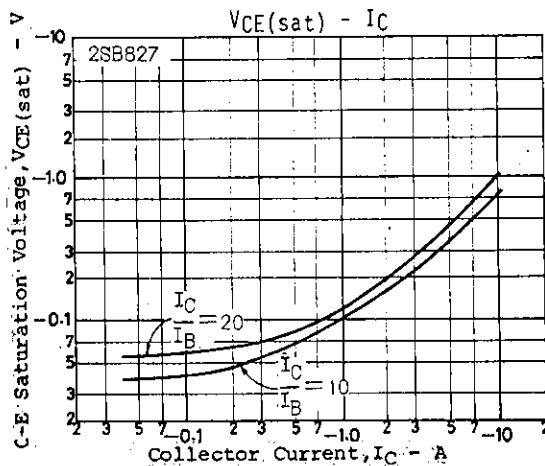
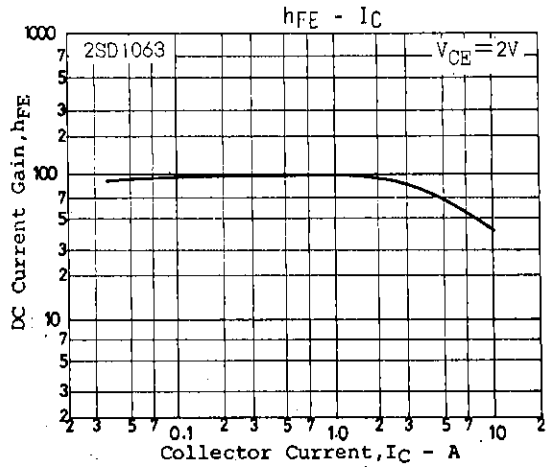
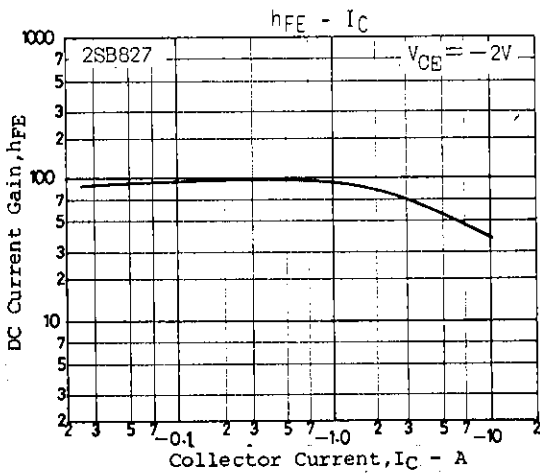
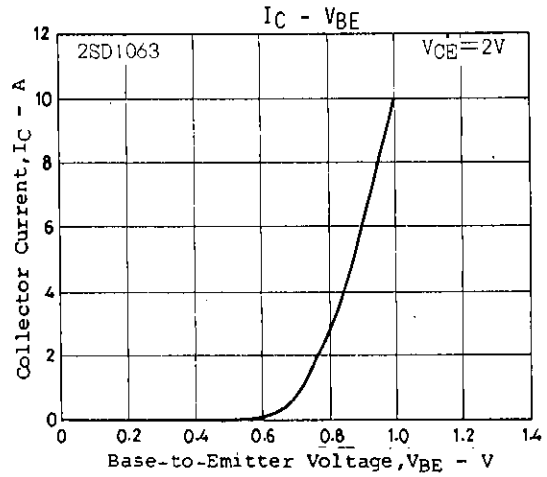
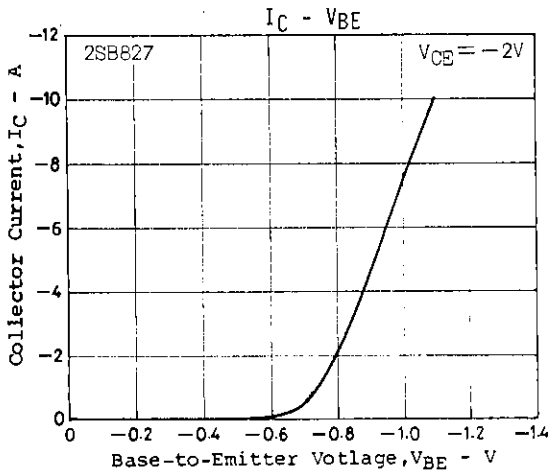
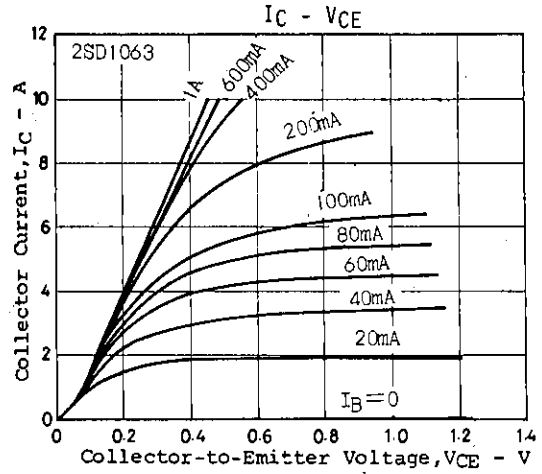
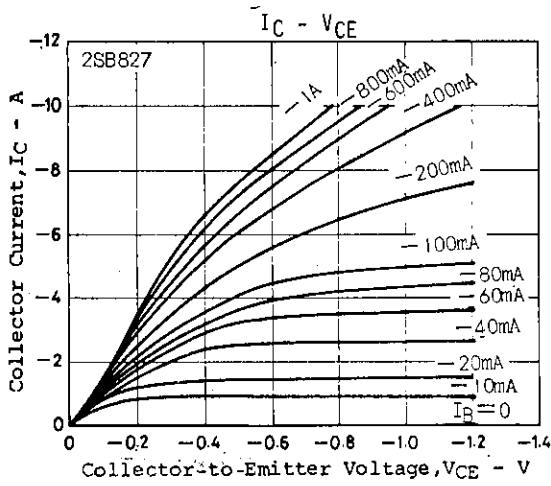

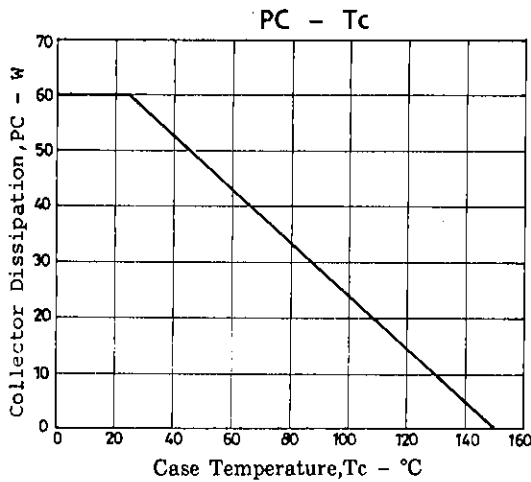
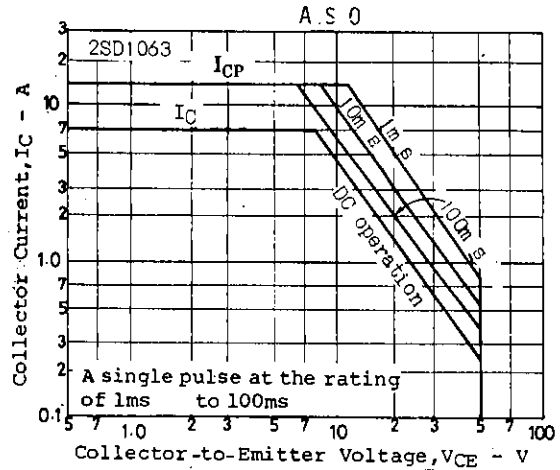
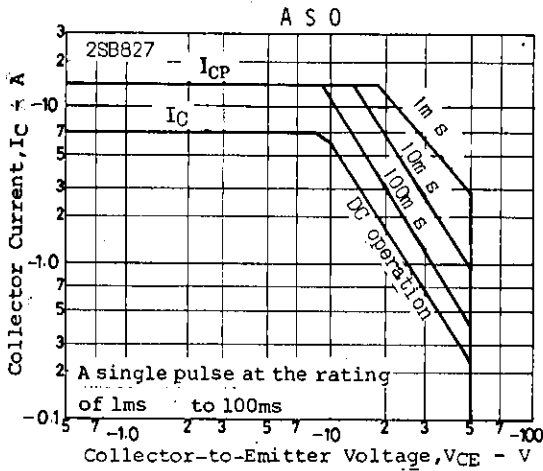

■ No products described or contained herein are intended for use in surgical implants, life-support systems, aerospace equipment, nuclear power control systems, vehicles, disaster/crime-prevention equipment and the like, the failure of which may directly or indirectly cause injury, death or property loss.

■ Anyone purchasing any products described or contained herein for an above-mentioned use shall:

- ① Accept full responsibility and indemnify and defend SANYO ELECTRIC CO., LTD., its affiliates, subsidiaries and distributors and all their officers and employees, jointly and severally, against any and all claims and litigation and all damages, cost and expenses associated with such use:
- ② Not impose any responsibility for any fault or negligence which may be cited in any such claim or litigation on SANYO ELECTRIC CO., LTD., its affiliates, subsidiaries and distributors or any of their officers and employees jointly or severally.

■ Information (including circuit diagrams and circuit parameters) herein is for example only; it is not guaranteed for volume production. SANYO believes information herein is accurate and reliable, but no guarantees are made or implied regarding its use or any infringements of intellectual property rights or other rights of third parties.