

PC713V/PC714V

- * Lead forming type (I type) and taping reel type (P type) are also available. (PC713V/PC714V/PC713VP/PC714VP) (Page 656)
 ** TÜV (VDE0884) approved type is also available as an option.

■ Features

1. TTL compatible output
2. Current transfer ratio
(CTR : MIN. 50% at $I_F=5\text{mA}$, $V_{CE}=5\text{V}$)
3. Low collector dark current
(I_{CEO} : MAX. 10^{-7}A at $V_{CE}=20\text{V}$)
4. High isolation voltage between input and output (V_{iso} : 5 000V_{rms})
5. Recognized by UL, file No. E64380

■ Applications

1. System appliances, measuring instruments
2. Registers, copiers, automatic vending machines
3. Electric home appliances such as fan heaters
4. Medical instruments, physical and chemical equipment
5. Signal transmission between circuits of different potentials and impedances

■ Absolute Maximum Ratings (Ta=25°C)

Parameter	Symbol	Rating	Unit
Forward current	I_F	50	mA
*1 Peak forward current	I_{FM}	1	A
Reverse voltage	V_R	6	V
Power dissipation	P	70	mW
Collector-emitter voltage	V_{CEO}	35	V
Emitter-collector voltage	V_{ECO}	6	V
*2 Collector-base voltage	V_{CBO}	35	V
*2 Emitter-base voltage	V_{EBO}	6	V
Collector current	I_C	50	mA
Collector power dissipation	P_C	150	mW
Total power dissipation	P_{tot}	170	mW
*3 Isolation voltage	V_{iso}	5 000	V _{rms}
Operating temperature	T_{opr}	-25 to +100	°C
Storage temperature	T_{stg}	-40 to +125	°C
*4 Soldering temperature	T_{sol}	260	°C

*1 Pulse width $\leq 100\ \mu\text{s}$, Duty ratio = 0.001

*2 Applies only to PC713V

*3 40 to 60%RH, AC for 1 minute

*4 For 10 seconds

High Isolation Voltage Type, General Purpose Photocoupler

■ Outline Dimensions

(Unit : mm)

PC713V

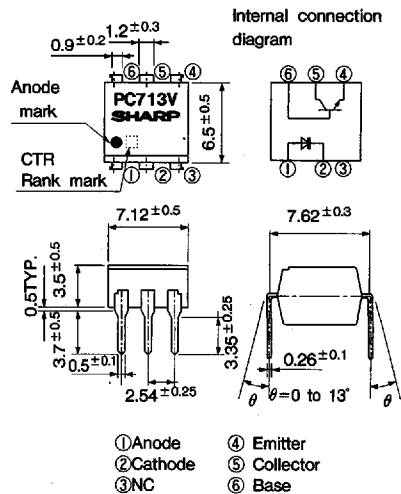

PC714V

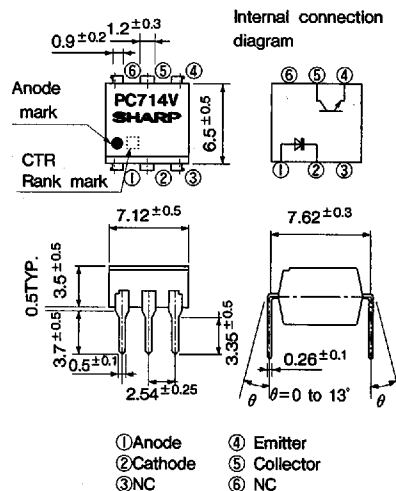

Electro-optical Characteristics

(T_a = 25°C)

Parameter		Symbol	Conditions	MIN.	TYP.	MAX.	Unit
Input	Forward voltage	V _F	I _F = 20mA	—	1.2	1.4	V
	Peak forward voltage	V _{FM}	I _{FM} = 0.5A	—	—	3.0	V
	Reverse current	I _R	V _R = 4V	—	—	10	μA
	Terminal capacitance	C _t	V = 0, f = 1kHz	—	30	250	pF
Output	Collector dark current	I _{CEO}	V _{CE} = 20V, I _F = 0, *5R _{BE} = ∞	—	—	10 ⁻⁷	A
Transfer characteristics	*6Current transfer ratio	CTR	I _F = 5mA, V _{CE} = 5V, *5R _{BE} = ∞	50	—	600	%
	Collector-emitter saturation voltage	V _{CE(sat)}	I _F = 20mA, I _C = 1mA, *5R _{BE} = ∞	—	0.1	0.2	V
	Isolation resistance	R _{ISO}	DC500V, 40 to 60%RH	5 × 10 ¹⁰	10 ¹¹	—	Ω
	Floating capacitance	C _f	V = 0, f = 1MHz	—	0.6	1.0	pF
	Cut-off frequency	f _c	V _{CE} = 5V, I _C = 2mA, R _L = 100Ω, *5R _{BE} = ∞	—	80	—	kHz
	Response time	Rise time	t _r	V _{CE} = 2V, I _C = 2mA R _L = 100Ω, *5R _{BE} = ∞	—	4	18
Fall time		t _f	—		3	18	μs

*5 Applies only to PC713V

*6 Classification table of current transfer ratio is shown below.

Model No.	Rank mark	CTR(%)
PC713V1/PC714V1	A	80 to 160
PC713V2/PC714V2	B	130 to 260
PC713V3/PC714V3	C	200 to 400
PC713V5/PC714V5	A or B	80 to 260
PC713V6/PC714V6	B or C	130 to 400
PC713V8/PC714V8	A, B or C	80 to 400
PC713V/PC714V	A, B, C or no marking	50 to 600

Measurement conditions

I_F = 5mAV_{CE} = 5VT_a = 25°C

Fig. 1 Forward Current vs. Ambient Temperature

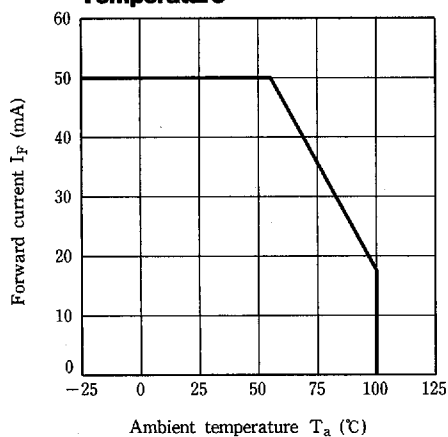

Fig. 2 Collector Power Dissipation vs. Ambient Temperature

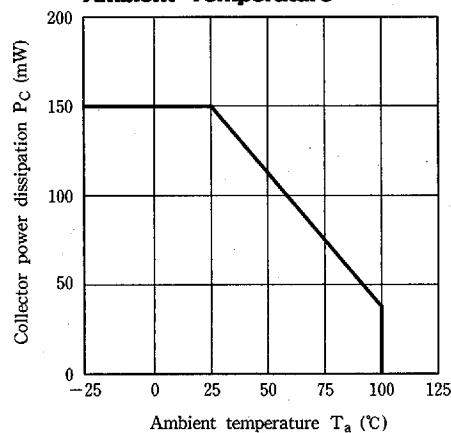

Fig. 3 Peak Forward Current vs. Duty Ratio

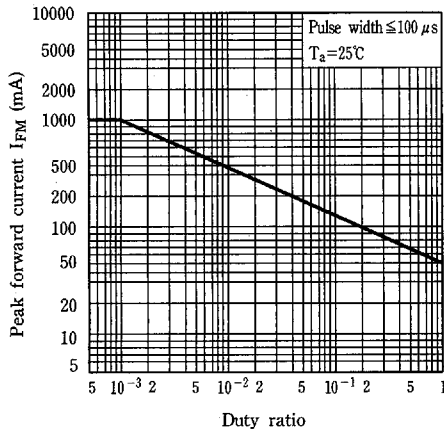

Fig. 4 Forward Current vs. Forward Voltage

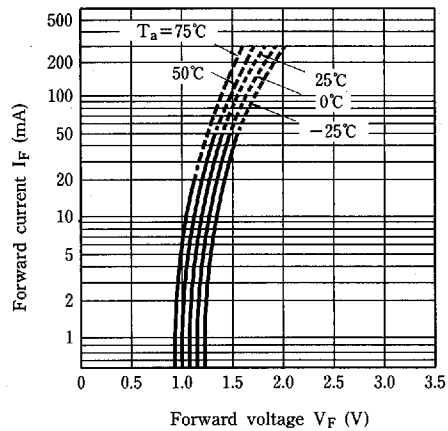

Fig. 5 Current Transfer Ratio vs. Forward Current

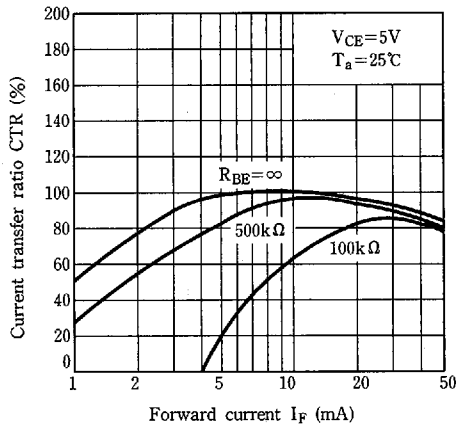

Fig. 6 Collector Current vs. Collector-emitter Voltage

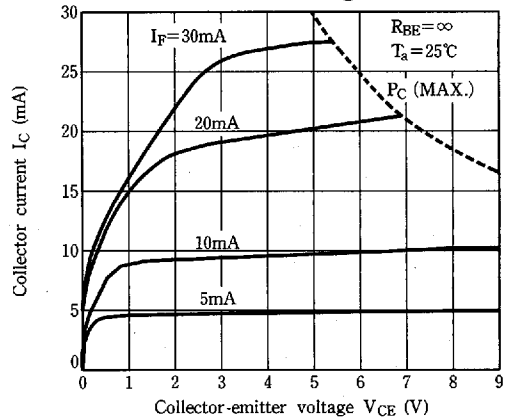

Fig. 7 Relative Current Transfer Ratio vs. Ambient Temperature

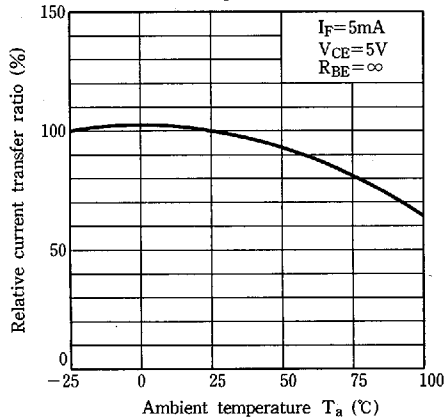

Fig. 8 Collector-emitter Saturation Voltage vs. Ambient Temperature

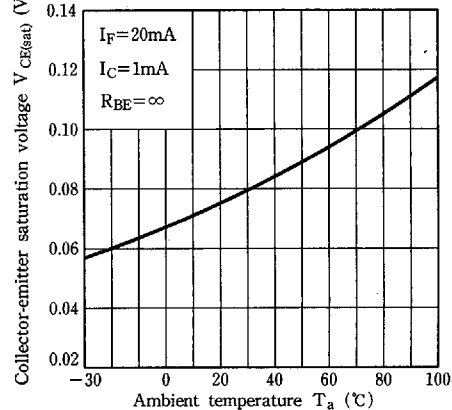

Fig. 9 Collector Dark Current vs. Ambient Temperature

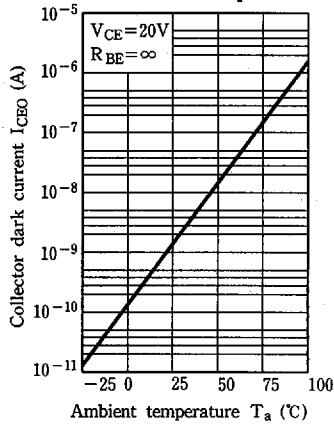

Fig.10 Collector-base Dark Current vs. Ambient Temperature

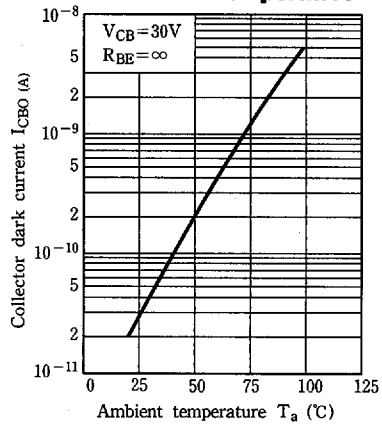

Fig.11 Response Time vs. Load Resistance

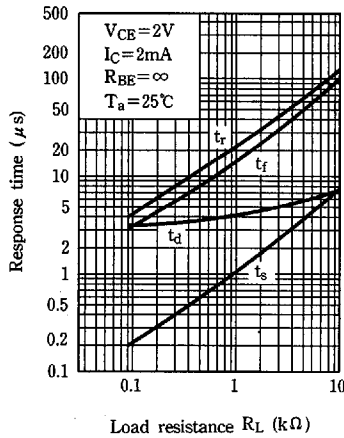
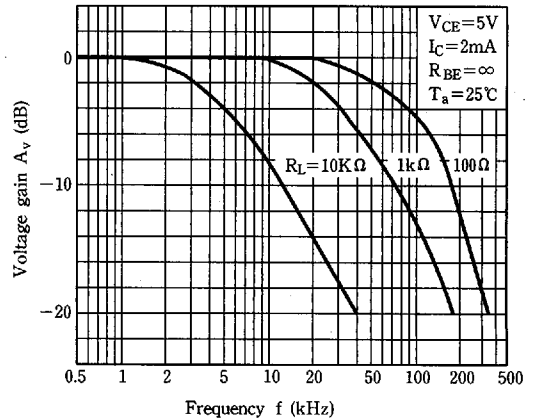
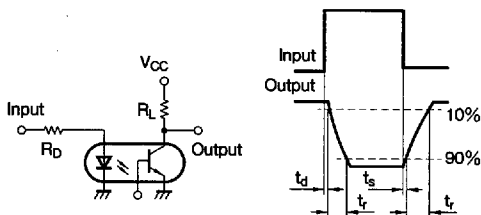

Fig.12 Frequency Response



Test Circuit for Response Time



(PC714V has no base terminal.)

Test Circuit for Frequency Response

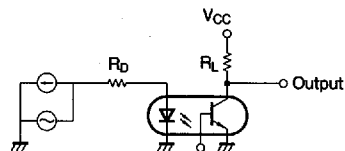

(PC714V has no base terminal.)

● Please refer to the chapter "Precautions for Use". (Page 78 to 93)