

## NDH8436 N-Channel Enhancement Mode Field Effect Transistor

### General Description

These N-Channel enhancement mode power field effect transistors are produced using National's proprietary, high cell density, DMOS technology. This very high density process is especially tailored to minimize on-state resistance, provide superior switching performance, and withstand high energy pulses in the avalanche and commutation modes. These devices are particularly suited for low voltage applications such as disk drive motor control, battery powered circuits, and DC/DC conversion where fast switching, low in-line power loss, and resistance to transients are needed.

### Features

- 5.8A, 30V.  $R_{DS(ON)} = 0.03\Omega @ V_{GS} = 10V$   
 $R_{DS(ON)} = 0.045\Omega @ V_{GS} = 4.5V$
- High density cell design for extremely low  $R_{DS(ON)}$ .
- Enhanced SuperSOT™-8 small outline surface mount package with high power and current handling capability.

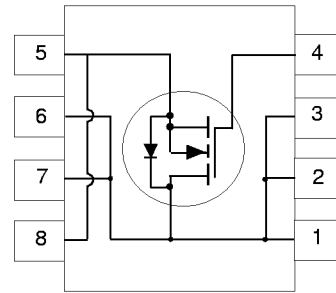
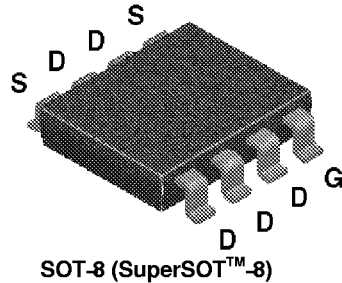

### Absolute Maximum Ratings $T_A = 25^\circ\text{C}$ unless otherwise noted

Symbol	Parameter	NDH8436	Units
$V_{DSS}$	Drain-Source Voltage	30	V
$V_{GSS}$	Gate-Source Voltage	20	V
$I_D$	Drain Current –Continuous (Note 1a)	5.8	A
	– Pulsed	20	
$P_D$	Maximum Power Dissipation (Note 1a)	1.8	W
	(Note 1b)	1	
	(Note 1c)	0.9	
$T_J, T_{STG}$	Operating and Storage Temperature Range	-55 to 150	$^\circ\text{C}$

### THERMAL CHARACTERISTICS

$R_{\theta JA}$	Thermal Resistance, Junction-to-Ambient (Note 1a)	70	$^\circ\text{C/W}$
$R_{\theta JC}$	Thermal Resistance, Junction-to-Case (Note 1)	20	$^\circ\text{C/W}$

**ELECTRICAL CHARACTERISTICS** ( $T_A = 25^\circ\text{C}$  unless otherwise noted)

Symbol	Parameter	Conditions	Min	Typ	Max	Units	
<b>OFF CHARACTERISTICS</b>							
$BV_{DSS}$	Drain-Source Breakdown Voltage	$V_{GS} = 0\text{ V}, I_D = 250\ \mu\text{A}$	30			V	
$I_{DSS}$	Zero Gate Voltage Drain Current	$V_{DS} = 24\text{ V}, V_{GS} = 0\text{ V}$			1	$\mu\text{A}$	
			$T_J = 55^\circ\text{C}$		10	$\mu\text{A}$	
$I_{GSSF}$	Gate -Body Leakage, Forward	$V_{GS} = 20\text{ V}, V_{DS} = 0\text{ V}$			100	nA	
$I_{GSSR}$	Gate -Body Leakage, Reverse	$V_{GS} = -20\text{ V}, V_{DS} = 0\text{ V}$			-100	nA	
<b>ON CHARACTERISTICS</b> (Note 2)							
$V_{GS(th)}$	Gate Threshold Voltage	$V_{DS} = V_{GS}, I_D = 250\ \mu\text{A}$	1	1.6	2.8	V	
			$T_J = 125^\circ\text{C}$	0.7	1.2		2.2
$R_{DS(on)}$	Static Drain-Source On-Resistance	$V_{GS} = 10\text{ V}, I_D = 5.8\text{ A}$		0.022	0.03	$\Omega$	
			$T_J = 125^\circ\text{C}$		0.032		0.06
			$V_{GS} = 4.5\text{ V}, I_D = 5\text{ A}$		0.035		0.045
$I_{D(on)}$	On-State Drain Current	$V_{GS} = 10\text{ V}, V_{DS} = 5\text{ V}$	20			A	
$g_{FS}$	Forward Transconductance	$V_{DS} = 10\text{ V}, I_D = 3.5\text{ A}$		11		S	
<b>DYNAMIC CHARACTERISTICS</b>							
$C_{iss}$	Input Capacitance	$V_{DS} = 15\text{ V}, V_{GS} = 0\text{ V},$ $f = 1.0\text{ MHz}$		560		pF	
$C_{oss}$	Output Capacitance			360		pF	
$C_{rss}$	Reverse Transfer Capacitance			125		pF	
<b>SWITCHING CHARACTERISTICS</b> (Note 2)							
$t_{D(on)}$	Turn -On Delay Time	$V_{DD} = 15\text{ V}, I_D = 1\text{ A},$ $V_{GEV} = 10\text{ V}, R_{GEV} = 6\ \Omega$		12	20	ns	
$t_r$	Turn -On Rise Time			15	25	ns	
$t_{D(off)}$	Turn -Off Delay Time			24	40	ns	
$t_f$	Turn -Off Fall Time			12	20	ns	
$Q_g$	Total Gate Charge		$V_{DS} = 15\text{ V},$ $I_D = 5.8\text{ A}, V_{GS} = 10\text{ V}$		20	30	nC
$Q_{gs}$	Gate-Source Charge			2.2		nC	
$Q_{gd}$	Gate-Drain Charge			5.2		nC	

**ELECTRICAL CHARACTERISTICS** ( $T_A = 25^\circ\text{C}$  unless otherwise noted)

Symbol	Parameter	Conditions	Min	Typ	Max	Units
<b>DRAIN-SOURCE DIODE CHARACTERISTICS AND MAXIMUM RATINGS</b>						
$I_S$	Maximum Continuous Drain-Source Diode Forward Current				1.5	A
$V_{SD}$	Drain-Source Diode Forward Voltage	$V_{GS} = 0\text{ V}$ , $I_S = 1.5\text{ A}$ (Note 2)			1.2	V

Notes:

- $R_{\theta_{JA}}$  is the sum of the junction-to-case and case-to-ambient thermal resistance where the case thermal reference is defined as the solder mounting surface of the drain pins.  $R_{\theta_{JC}}$  is guaranteed by design while  $R_{\theta_{CA}}$  is determined by the user's board design.

$$P_D(t) = \frac{T_J - T_A}{R_{\theta_{JA}}(t)} = \frac{T_J - T_A}{R_{\theta_{JC}} + R_{\theta_{CA}}(t)} = I_D^2(t) \times R_{DS(on)} @ T_J$$

Typical  $R_{\theta_{JA}}$  using the board layouts shown below on 4.5"x5" FR-4 PCB in a still air environment:

- 70°C/W when mounted on a 1 in<sup>2</sup> pad of 2oz copper.
- 125°C/W when mounted on a 0.026 in<sup>2</sup> pad of 2oz copper.
- 135°C/W when mounted on a 0.005 in<sup>2</sup> pad of 2oz copper.

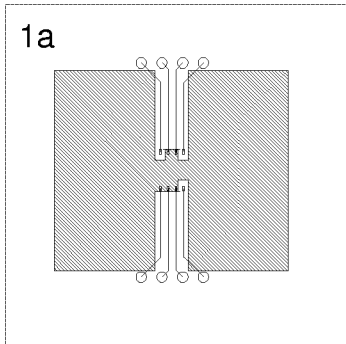

Scale 1 : 1 on letter size paper

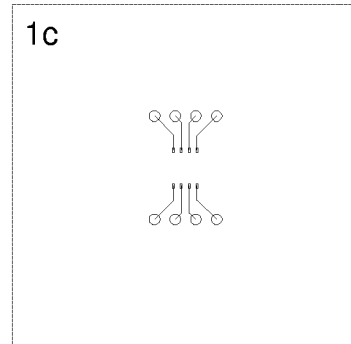
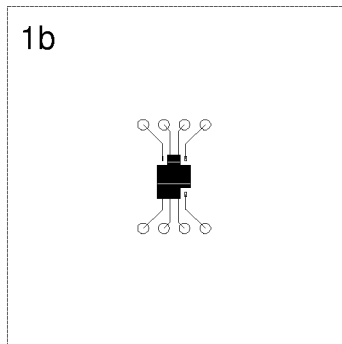

- Pulse Test: Pulse Width  $\leq 300\mu\text{s}$ , Duty Cycle  $\leq 2.0\%$ .

## Typical Electrical Characteristics

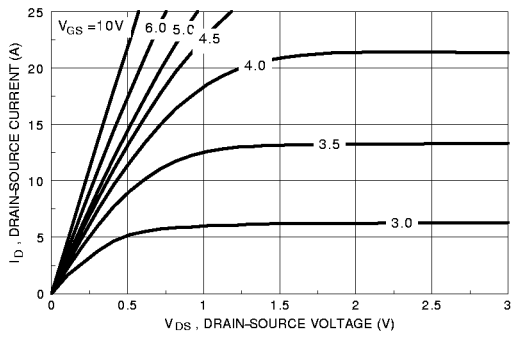

Figure 1. On-Region Characteristics.

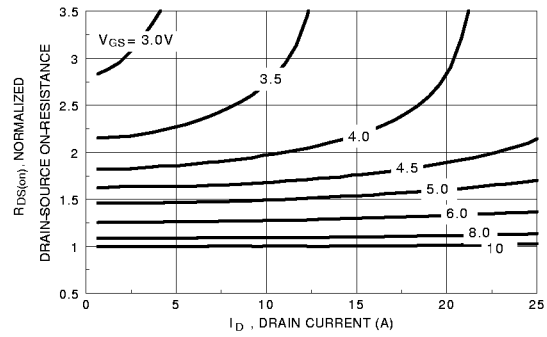

Figure 2. On-Resistance Variation with Drain Current and Gate Voltage.

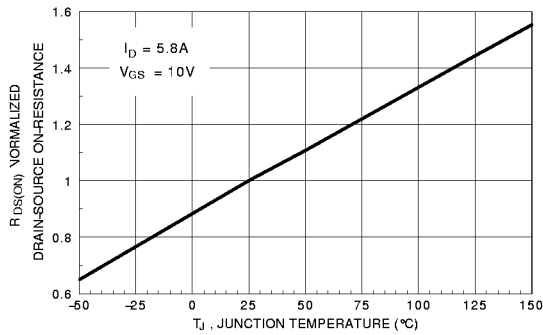

Figure 3. On-Resistance Variation with Temperature.

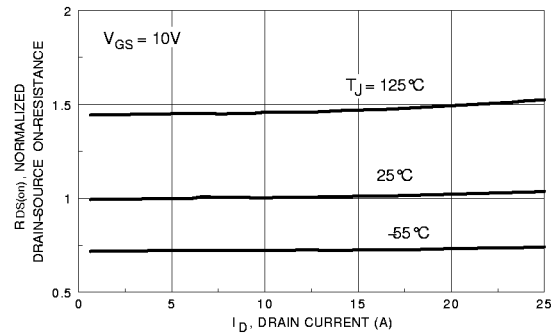

Figure 4. On-Resistance Variation with Drain Current and Temperature.

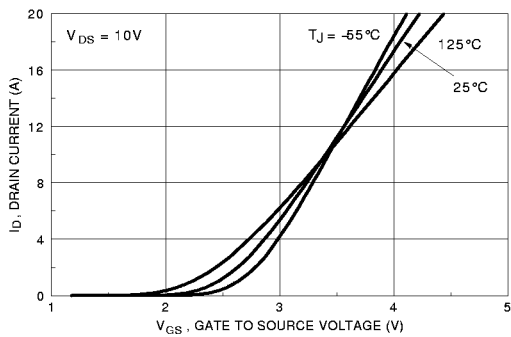

Figure 5. Transfer Characteristics.

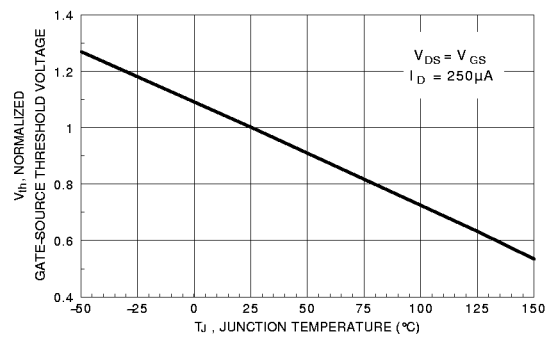

Figure 6. Gate Threshold Variation with Temperature.

## Typical Electrical Characteristics (continued)

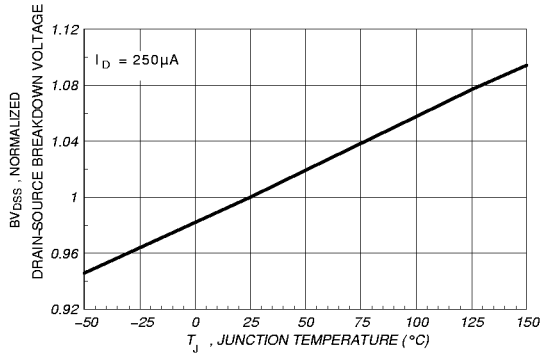

Figure 7. Breakdown Voltage Variation with Temperature.

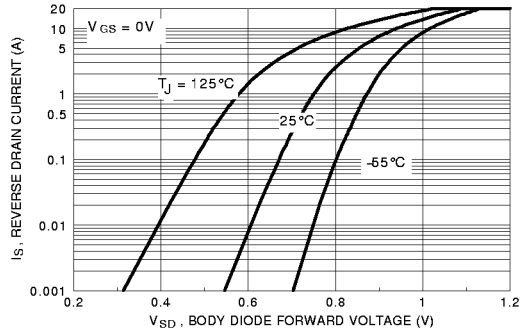

Figure 8. Body Diode Forward Voltage Variation with Source Current and Temperature.

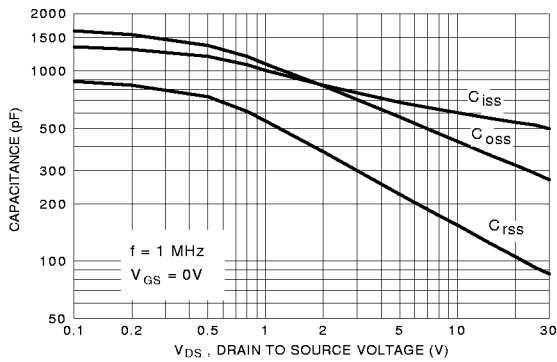

Figure 9. Capacitance Characteristics.

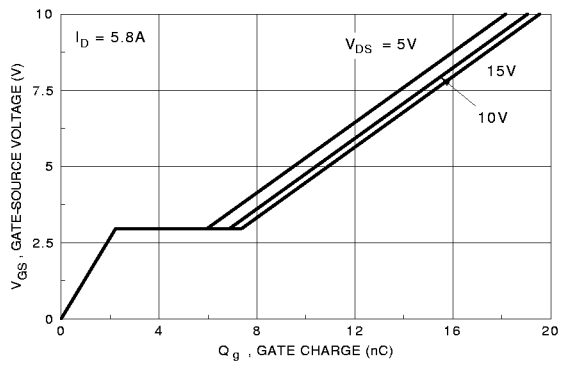

Figure 10. Gate Charge Characteristics.

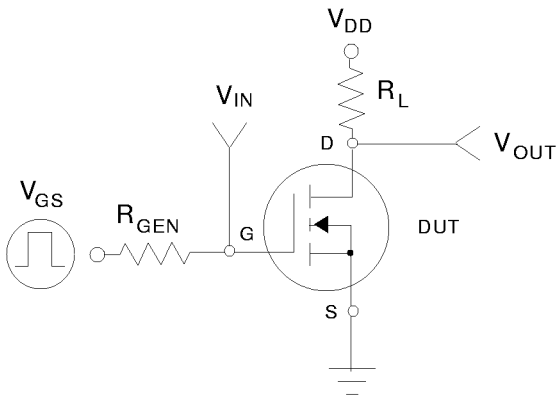

Figure 11. Switching Test Circuit.

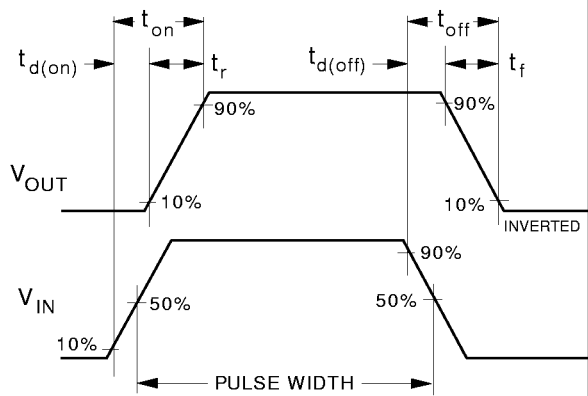
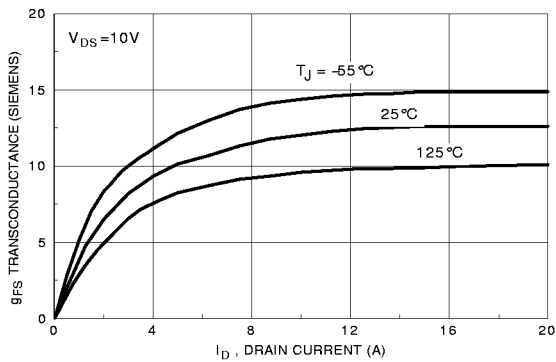
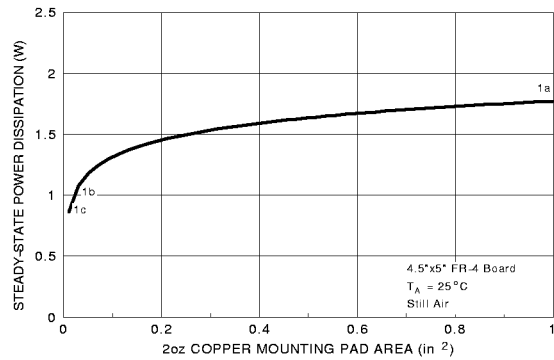

Figure 12. Switching Waveforms.

## Typical Electrical and Thermal Characteristics (continued)



**Figure 13. Transconductance Variation with Drain Current and Temperature.**



**Figure 14. SOT-8 Maximum Steady-State Power Dissipation versus Copper Mounting Pad Area.**

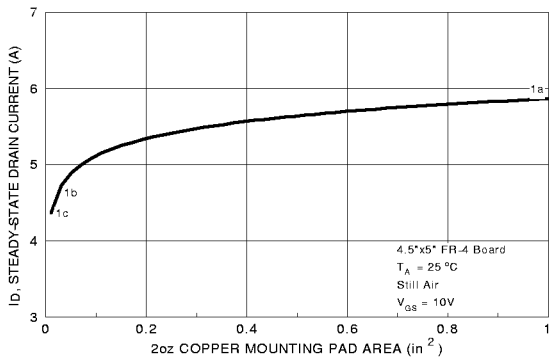

**Figure 15. Maximum Steady-State Drain Current versus Copper Mounting Pad Area.**

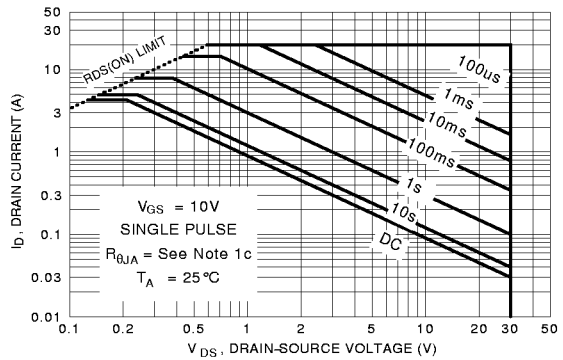

**Figure 16. Maximum Safe Operating Area.**

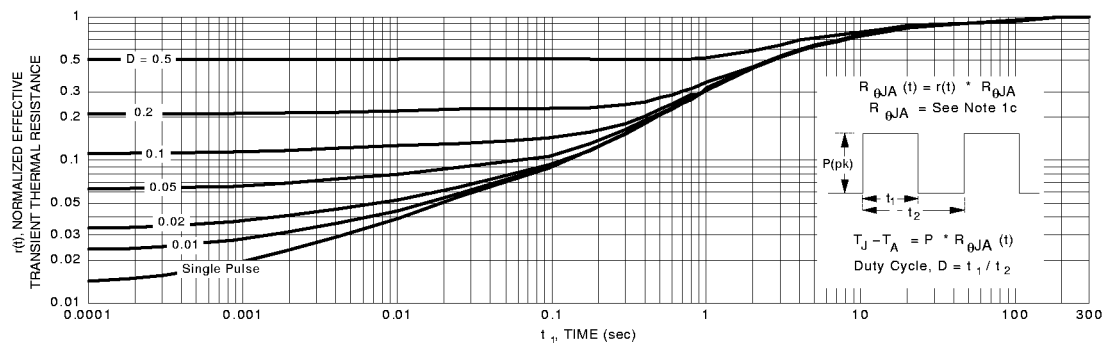

**Figure 17. Transient Thermal Response Curve.**

Note: Thermal characterization performed using the conditions described in note 1c. Transient thermal response will change depending on the circuit board design.