

Specifications

Parameter	Unit	Minimum	Typical	Maximum
Center Frequency	MHz	69.95	70	70.05
Insertion Loss	dB		27.5	29
1dB Bandwidth	MHz	18.7	18.86	
3 dB Bandwidth	MHz	18.9	19.08	
40 dB Bandwidth	MHz		19.85	19.9
50 dB Bandwidth	MHz		19.92	20
Passband Variation	dB		0.8	1
Absolute Delay	usec		3.67	
Ultimate Rejection($f_0 \pm 10\text{MHz}$)	dB	50	55	
Substrate Material			YZ	
Ambient Temperature	°C		25	
Package Size		DIP3512 (35.2x12.7x5.2mm ³)		

Notes:

1. All specifications are based on the test circuit shown
2. In production, devices will be tested at room temperature to a guardbanded specification to ensure electrical compliance over temperature
3. Electrical margin has been built into the design to account for the variations due to temperature drift and manufacturing tolerances
4. This is the optimum impedance in order to achieve the performance show

Matching Configuration

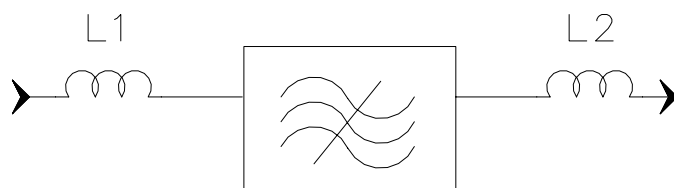

L1 = 100nH L2 = 120nH

Source/Load Impedance = 50 ohm

Notes - Component values may change depending on board layout.



SIPAT Co., Ltd.
(CETC No. 26 Research Institute)
Nanping Huayuan Road No. 14
Chongqing, China, 400060

Part Number	LBN7055		
Rev. Date	2005-4-6		
Rev.	2.0	Page 1/3	

Package Dimension

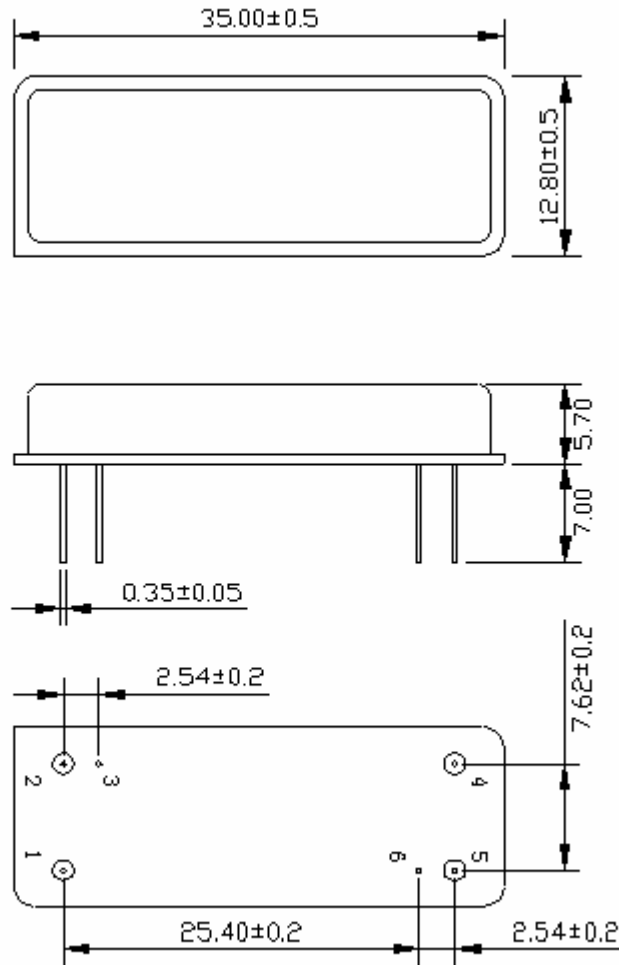

INPUT: 1
Output: 5



SIPAT Co., Ltd.
(CETC No. 26 Research Institute)
Nanping Huayuan Road No. 14
Chongqing, China, 400060

Part Number	LBN7055	
Rev. Date	2005-4-6	
Rev.	2.0	Page 2/3

Typical Performance

Frequency Respond

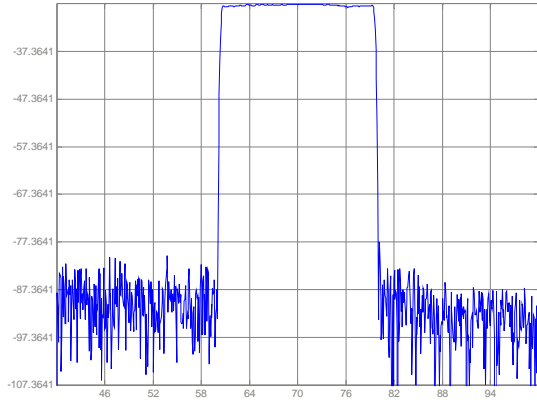

Passband Respond

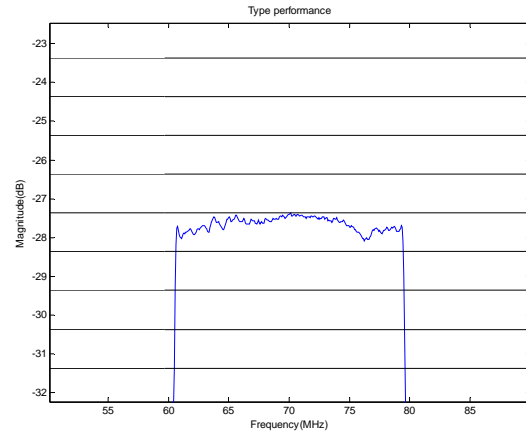

Group Delay Variation($f_0 \pm 7.48\text{MHz}$)

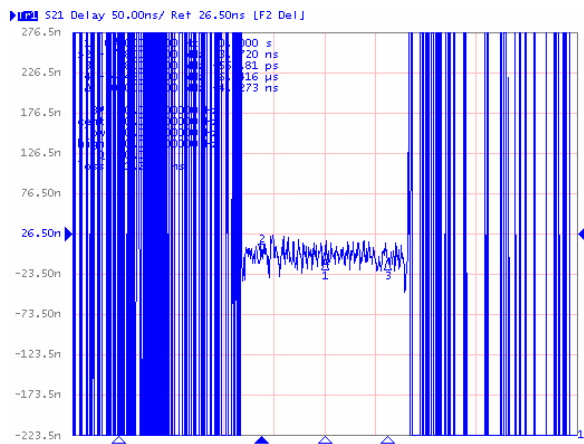

Phase Linearity($f_0 \pm 7.48\text{MHz}$)

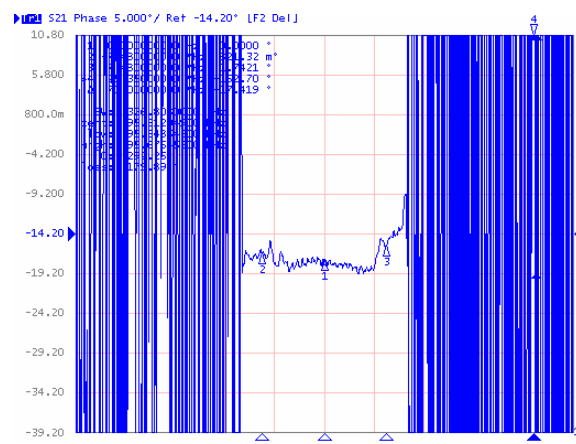

Smith Chart S11

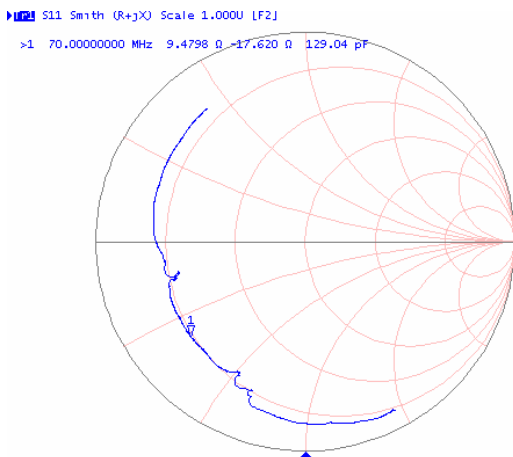

Smith Chart S22

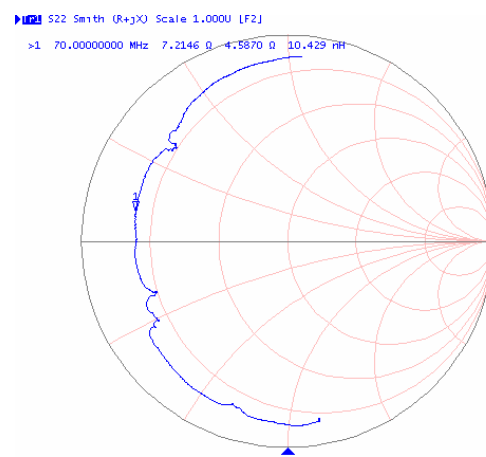

SIPAT Co., Ltd.
(CETC No. 26 Research Institute)
Nanping Huayuan Road No. 14
Chongqing, China, 400060

Part Number

LBN7055

Rev. Date

2005-4-6

Rev.

2.0

Page 3/3