

# Agilent HFCT-5215B/D 155 Mb/s Single Mode Laser Transceiver for ATM, SONET OC-3/SDH STM-1 (L1.1) Data Sheet



## Description

The HFCT-5215 transceiver is a high performance, cost effective module for serial optical data communications applications specified for a signal rate of 155 MBd. It is designed to provide a SONET/SDH compliant link for 155 Mb/s long reach links.

This module is designed for single mode fiber and operates at a nominal wavelength of 1300 nm. It incorporates Agilent's high performance, reliable, long wavelength optical devices and proven circuit technology to give long life and consistent service.

The transmitter section uses a Multiple Quantum Well laser with full IEC 825 and CDRH Class I eye safety.

The receiver section uses a planar PIN photodetector for low dark current and excellent responsivity.

A pseudo-ECL logic interface simplifies interface to external circuitry.

## Features

- SC duplex single mode transceiver
- Long reach SONET OC3 SDH STM1 (L1.1) compliant
- Single +5 V power supply
- Multisourced 1 x 9 pin package style
- Aqueous washable plastic package
- Interchangeable with LED multisourced 1 x 9 transceivers
- Unconditionally eye safe laser IEC 825/CDRH Class 1 compliant

## Applications

- ATM 155 Mb/s links
- SONET OC-3/SDH STM-1 interconnections



**Agilent Technologies**

Innovating the HP Way

## Connection Diagram

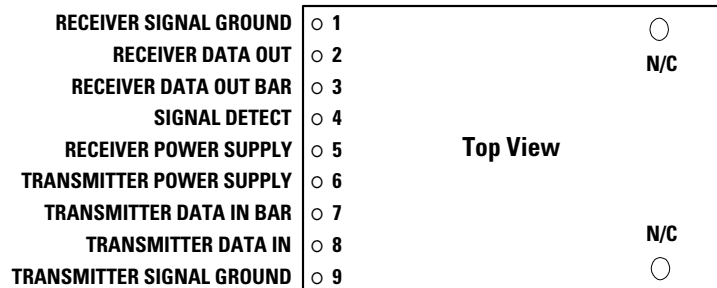

### Pin Descriptions:

#### Pin 1 Receiver Signal Ground $V_{EER}$ :

Directly connect this pin to the receiver ground plane.

#### Pin 2 Receiver Data Out $RD$ :

See recommended circuit schematic, Figure 4.

#### Pin 3 Receiver Data Out Bar $\overline{RD}$ :

See recommended circuit schematic, Figure 4.

#### Pin 4 Signal Detect $SD$ :

Normal optical input levels to the receiver result in a logic “1” output.

Low optical input levels to the receiver result in a fault condition indicated by a logic “0” output.

This Signal Detect output can be used to drive a PECL input on an upstream circuit, such as Signal Detect input or Loss of Signal-bar.

#### Pin 5 Receiver Power Supply $V_{CCR}$ :

Provide +5 V dc via the recommended transmitter power supply filter circuit. Locate the power supply filter circuit as close as possible to the  $V_{CC}$  pin.

#### Pin 6 Transmitter Power Supply $V_{CCT}$ :

Provide +5 V dc via the recommended transmitter power supply filter circuit. Locate the power supply filter circuit as close as possible to the  $V_{CC}$  pin.

#### Pin 7 Transmitter Data In Bar $\overline{TD}$ :

See recommended circuit schematic, Figure 4.

#### Pin 8 Transmitter Data In $TD$ :

See recommended circuit schematic, Figure 4.

#### Pin 9 Transmitter Signal Ground $V_{EET}$ :

Directly connect this pin to the transmitter ground plane.

### Mounting Studs

The mounting studs are provided for mechanical attachment to the circuit board. They are embedded in the nonconductive plastic housing and are not tied to the transceiver internal circuit and should be soldered into plated-through holes on the printed circuit board.

## Functional Description Receiver Section

### Design

The receiver section contains an InGaAs/InP photo detector and a preamplifier within the receptacle, coupled to a postamp/decision circuit on a separate circuit board.

The postamplifier is ac coupled to the preamplifier as illustrated in Figure 1. The coupling capacitor is large enough to pass the SONET/SDH test pattern at 155 MBd without significant distortion or performance penalty. If a lower signal rate, or a code which has significantly more low frequency content is used, sensitivity, jitter and pulse distortion could be degraded.

Figure 1 also shows a filter network which limits the bandwidth of the preamp output signal. The filter is designed to bandlimit the preamp output noise and thus improve the receiver sensitivity.

These components will also reduce the sensitivity of the receiver as the signal bit rate is increased above 155 MBd.

### Noise Immunity

The receiver includes internal circuit components to filter power supply noise. Under some EMI and power supply noise conditions, external power supply filtering may be necessary. If receiver sensitivity is degraded by power supply noise, the filter network illustrated in Figure 2 may be employed to improve performance. The values of the filter components are general recommendations and may be changed to suit a particular system environment. Shielded inductors are recommended.

### Terminating the Outputs

The PECL Data outputs of the receiver may be terminated with the standard Thevenin-equivalent 50 ohm to  $V_{CC} - 2V$  termination. Other standard PECL terminating techniques may be used.

The two outputs of the receiver should be terminated with identical load circuits to avoid unnecessarily large ac current in  $V_{CC}$ . If the outputs are loaded identically the ac current is largely nulled. The Signal Detect output of the receiver is PECL logic and must be loaded when used. The Signal Detect circuit is much slower than the data path, so the ac noise generated by an asymmetrical load is negligible. Power consumption may be reduced by using a higher than normal load impedance for the Signal Detect output. Transmission line effects are not generally a problem as the switching rate is slow.

### The Signal Detect Circuit

The Signal Detect circuit works by sensing the peak level of the received signal and comparing this level to a reference.

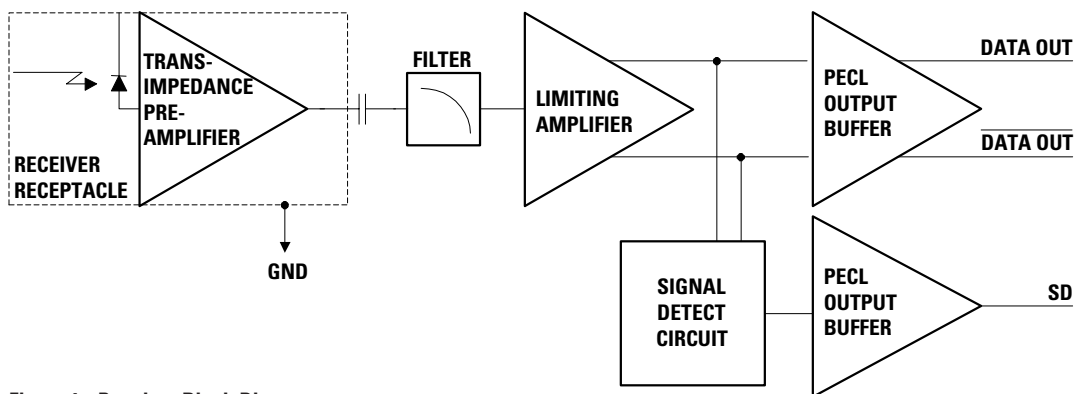

Figure 1 - Receiver Block Diagram

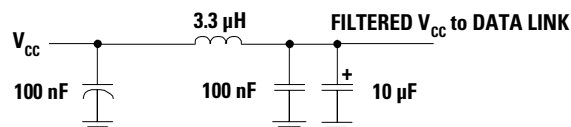

Figure 2 - Filter Network for Noise Filtering

## Functional Description

### Transmitter Section

#### Design

The transmitter section, Figure 3, uses a Multiple Quantum Well laser as its optical source. The packaging of this laser is designed for repeatable coupling into single mode fiber while maintaining compliancy with IEC 825 Class 1 and CDRH Class I eye safety requirements. The optical output is controlled by a custom IC which detects the laser output via the monitor photodiode. This IC provides both dc and ac current drive to the laser to ensure correct modulation, eye diagram and extinction ratio over temperature, supply voltage and life.

#### PCB mounting

The HFCT-5215 has two solderable mounting studs. These studs are not electrically connected. The transceiver is designed for common production processes. It may be wave soldered and aqueous washed providing the process plug is in place.

Each process plug can only be used once during processing, although with subsequent use, it can be used as a dust cover.

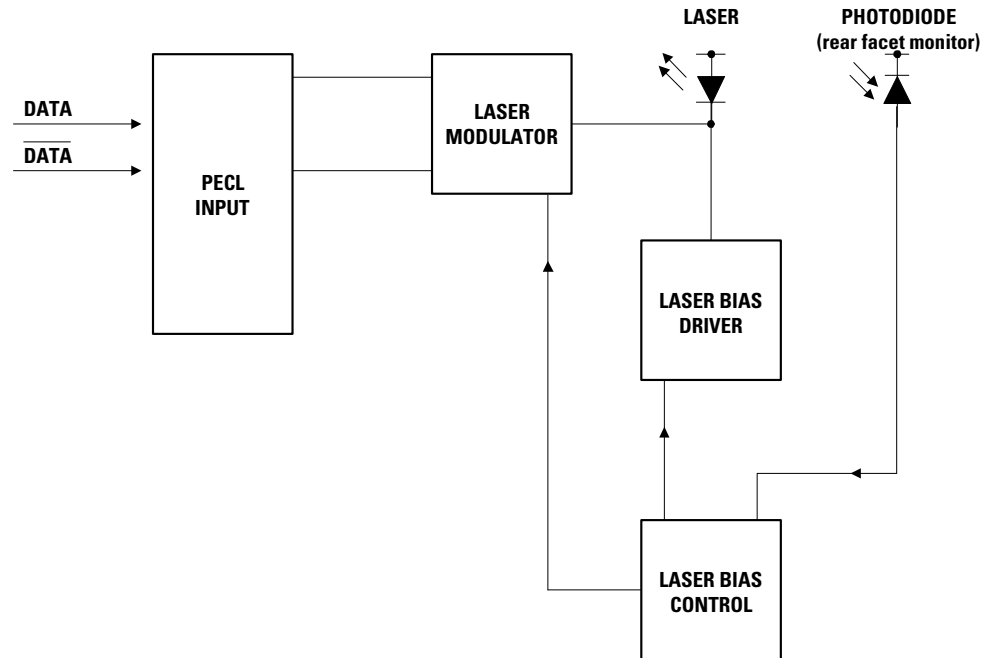

Figure 3 - Simplified Transmitter Schematic

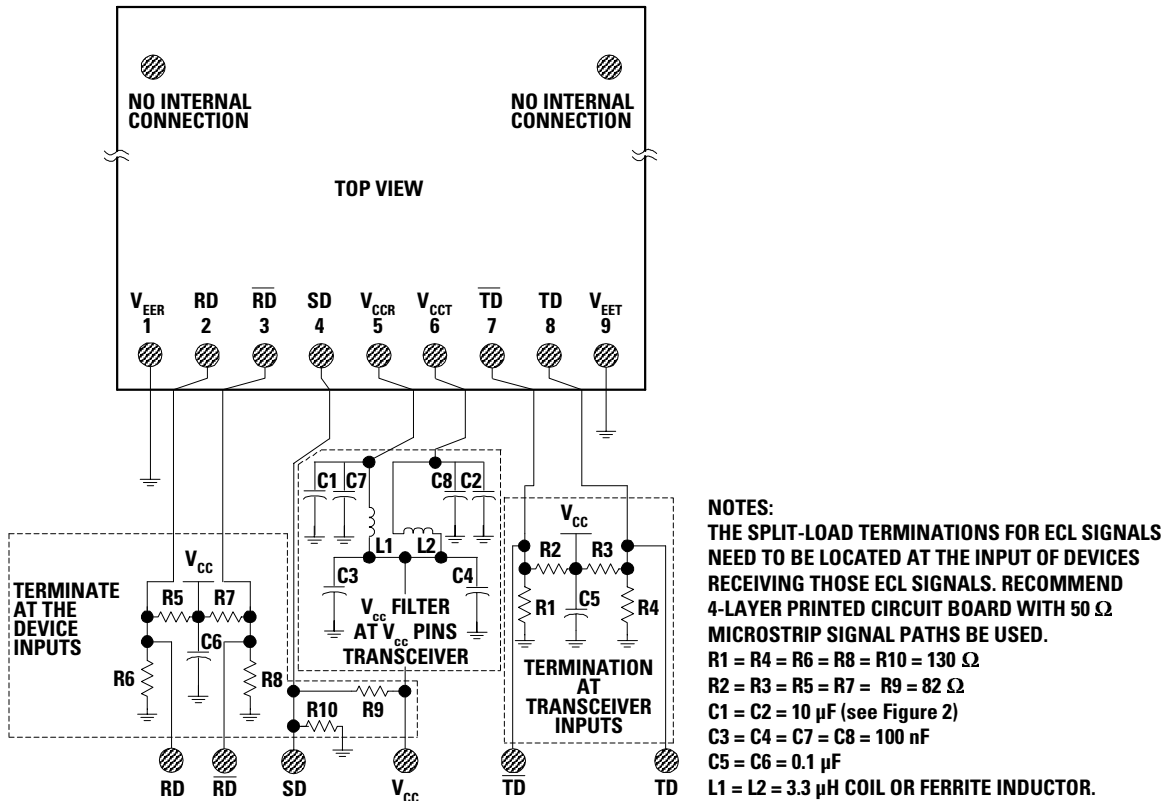

Figure 4 - Recommended Circuit Schematic

### Regulatory Compliance

Feature	Test Method	Performance
Electrostatic Discharge (ESD) to the Electrical Pins	MIL-STD-883C Method 3015.4	Class 1 (>1 kV) - Human Body Model
Electrostatic Discharge (ESD) to the Duplex SC Receptacle	Variation of IEC 801-2	Products of this type, typically, withstand at least 25 kV without damage when the Duplex SC Connector Receptacle is contacted by a Human Body Model probe.
Electromagnetic Interference (EMI)	FCC Class B CENELEC EN55022 Class B (CISPR 22A) VCCI Class 1	Typically provide a 17 dB margin to the noted standard limits up to 6 GHz, when tested in a GTEM cell with the transceiver mounted to a circuit card with a chassis enclosure.
Immunity	Variation of IEC 801-3	Typically show no measurable effect from a 10 V/m field swept from 27 MHz to 1 GHz applied to the transceiver without a chassis enclosure.
Eye Safety	FDA CDRH 21-CFR 1040 Class I IEC 825 Issue 1 1993:11 Class 1 CENELEC EN60825 Class 1	CDRH Accession Number: 9521220-26 TUV Bauart License: 933/510918/01

## Performance Specifications

### Absolute Maximum Ratings

Stresses in excess of the absolute maximum ratings can cause catastrophic damage to the device. Limits apply to each parameter in isolation, all other parameters having values within the recommended operating conditions. It should not be assumed that limiting values of more than one parameter can be applied to the product at the same time. Exposure to the absolute maximum ratings for extended periods can adversely affect device reliability.

Parameter	Symbol	Minimum	Maximum	Units	Notes
Storage Temperature	T <sub>S</sub>	-40	+85	°C	-
Operating Temperature	-	0	+70	°C	1
Lead Soldering Temperature/Time	-	-	+260/10	°C/s	-
Output Current (other outputs)	I <sub>OUT</sub>	0	30	mA	-
Input Voltage	-	GND	V <sub>CC</sub>	V	-
Power Supply Voltage	-	0	+6	V	-

### Operating Environment

Parameter	Symbol	Minimum	Maximum	Units	Notes
Power Supply Voltage	V <sub>CC</sub>	+4.75	+5.25	V	-
Ambient Operating Temperature	T <sub>OP</sub>	0	+70	°C	1

### Transmitter Section

(Ambient Operating Temperature V<sub>CC</sub> = 4.75V to 5.25V)

Parameter	Symbol	Minimum	Maximum	Units	Notes
Output Center Wavelength	λ <sub>C</sub>	1280	1335	nm	-
Output Spectral Width (RMS)	Δλ	-	4.0	nm	-
Average Optical Output Power	P <sub>O</sub>	-5	0	dBm	2
Extinction Ratio	E <sub>R</sub>	10	-	dB	-
Power Supply Current	I <sub>CC</sub>	-	140	mA	3
Output Eye	Compliant with Bellcore TR-NWT-000253 and ITU recommendation G.957				
Optical Rise Time	t <sub>R</sub>	-	2	ns	4
Optical Fall Time	t <sub>F</sub>	-	2	ns	4
Data Input Current - Low	I <sub>IL</sub>	-350	-	μA	-
Data Input Current - High	I <sub>IH</sub>	-	350	μA	-
Differential Input Voltage	V <sub>IH</sub> - V <sub>IL</sub>	300	-	mV	-
Data Input Voltage - Low	V <sub>OL</sub> - V <sub>CC</sub>	-2.0	-1.58	V	5
Data Input Voltage - High	V <sub>OH</sub> - V <sub>CC</sub>	-1.1	-0.74	V	5

#### Notes:

1. 2 m/s air flow required.
2. Output power is power coupled into a single mode fiber.
3. The power supply current varies with temperature. Maximum current is specified at V<sub>CC</sub> = Maximum @ maximum temperature (not including terminations) and end of life.
4. 10% - 90% Values
5. These inputs are compatible with 10K, 10KH and 100K ECL and PECL inputs.

## Receiver Section

(Ambient Operating Temperature  $V_{CC} = 4.75V$  to  $5.25V$ )

Parameter	Symbol	Minimum	Typical	Maximum	Units	Notes
Receiver Sensitivity	-	-34	-	-	dBm	6
Maximum Input Power	-	-8	-	-	dBm	-
Signal Detect - Asserted	$P_A$	$P_D + 0.5$	-	-34	dBm avg.	-
Signal Detect - Deasserted	$P_D$	-45	-	-	dBm avg.	-
Signal Detect - Hysteresis	$P_A - P_D$	0.5	-	4.0	dB	-
Power Supply Current	$I_{CC}$	-	80	100	mA	7
Data Output Voltage - Low	$V_{OL} - V_{CC}$	-2.0	-	-1.58	V	8
Data Output Voltage - High	$V_{OH} - V_{CC}$	-1.1	-	-0.74	V	8
Signal Detect Output Voltage - Low	$V_{OL} - V_{CC}$	-2.0	-	-1.58	V	8
Signal Detect Output Voltage - High	$V_{OH} - V_{CC}$	-1.1	-	-0.74	V	8

### Notes:

6. Minimum sensitivity and saturation levels for a 2<sup>23</sup>-1 PRBS with 72 ones and 72 zeros inserted. (ITU-T recommendation G.958).
7. The current excludes the output load current.
8. These outputs are compatible with 10K, 10KH and 100K ECL and PECL outputs.

# Drawing Dimensions

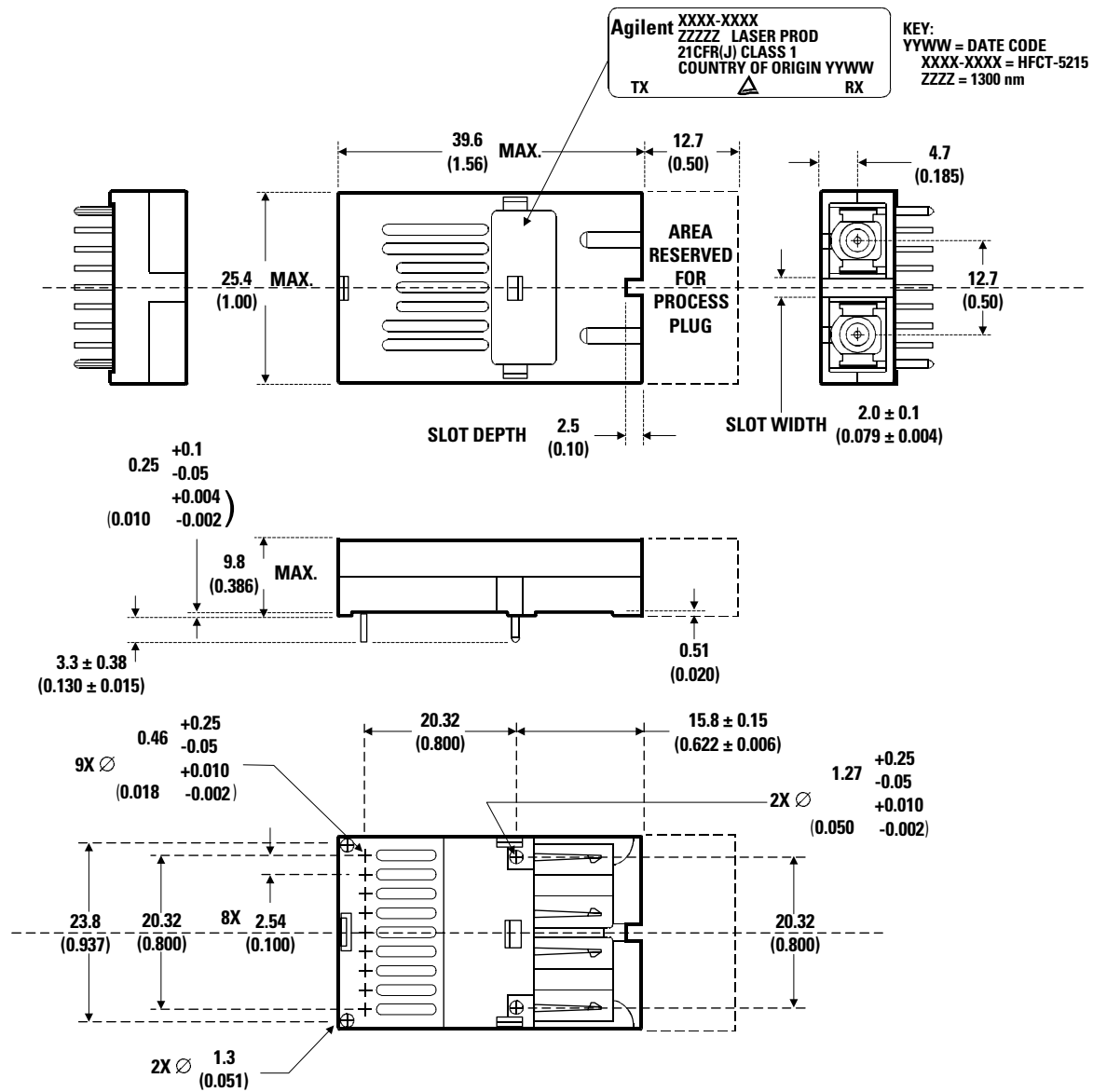

**DIMENSIONS ARE IN MILLIMETERS (INCHES).**  
**TOLERANCES: X.XX ±0.025 mm UNLESS OTHERWISE SPECIFIED.**  
 X.X ±0.05 mm

Figure 5. Package Outline Drawing for HFCT-5215



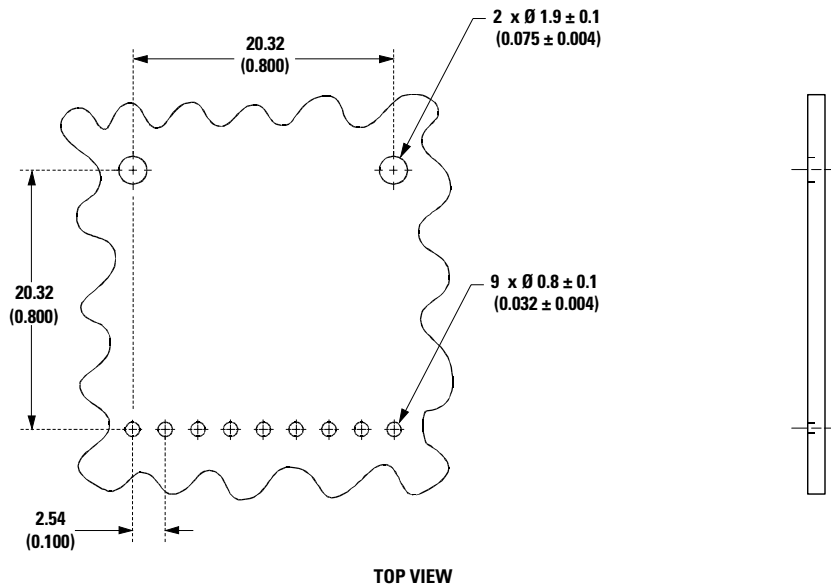

**DIMENSIONS ARE IN MILLIMETERS (INCHES)**

**Figure 6 . Recommended Board Layout Pattern**

**Ordering Information**

**Temperature Range 0°C to +70°C**

HFCT-5215B	Black Case
HFCT-5215D	Blue Case

**Supporting Documentation**

Application Note 1098  
 Characterization Report  
 Qualification Report

**Class 1 Laser Product:** This product conforms to the applicable requirements of 21 CFR 1040 at the date of manufacture  
 Date of Manufacture: \_\_\_\_\_  
 Agilent Technologies Ltd., Depot Road, Singapore

**Handling Precautions**

1. The HFCT-5215 can be damaged by current surges or overvoltage. Power supply transient precautions should be taken.
2. Normal handling precautions for electrostatic sensitive devices should be taken.

*[www.semiconductor.agilent.com](http://www.semiconductor.agilent.com)*

Data subject to change.

Copyright © 2001 Agilent Technologies, Inc.

Obsoletes: 5980-1856E

January 28, 2001

5988-2061EN



**Agilent Technologies**

Innovating the HP Way