

# 2SC5772

Silicon NPN Epitaxial  
UHF / VHF wide band amplifier

# HITACHI

ADE-208-1390 (Z)  
Preliminary 1st. Edition  
Mar. 2001

## Features

- High gain bandwidth product  
 $f_T = 9$  GHz typ.
- High power gain and low noise figure ;  
PG = 13 dB typ., NF = 1.1 dB typ. at  $f = 900$  MHz

## Outline

MPAK

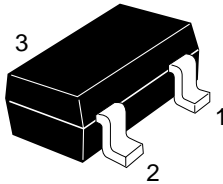

1. Emitter
2. Base
3. Collector

Note: Marking is "FR-".

This data sheet contains tentative specification for new product development. It may partially be subject to change without notice.

**Absolute Maximum Ratings (Ta = 25°C)**

Item	Symbol	Ratings	Unit
Collector to base voltage	$V_{CBO}$	15	V
Collector to emitter voltage	$V_{CEO}$	9	V
Emitter to base voltage	$V_{EBO}$	1.5	V
Collector current	$I_C$	75	mA
Collector power dissipation	Pc	700*	mW
Junction temperature	Tj	150	°C
Storage temperature	Tstg	-55 to +150	°C

\* When using aluminium ceramic board (25 x 60 x 0.7 mm)

**Electrical Characteristics (Ta = 25°C)**

Item	Symbol	Min	Typ	Max	Unit	Test Conditions
Collector to base breakdown voltage	$V_{(BR)CBO}$	15	—	—	V	$I_C = 10\mu A, I_E = 0$
Collector cutoff current	$I_{CBO}$	—	—	1	$\mu A$	$V_{CB} = 12 V, I_E = 0$
Collector cutoff current	$I_{CEO}$	—	—	1	mA	$V_{CE} = 9 V, R_{BE} = \infty$
Emitter cutoff current	$I_{EBO}$	—	—	10	$\mu A$	$V_{EB} = 1.5 V, I_C = 0$
DC current transfer ratio	$h_{FE}$	80	120	160	V	$V_{CE} = 5 V, I_C = 20 mA$
Collector output capacitance	Cob	—	0.9	1.5	pF	$V_{CB} = 5 V, I_E = 0$ $f = 1 MHz$
Reverse transfer capacitance	Cre	—	0.7	—	pF	$V_{CB} = 5 V, I_E = 0$ $f = 1 MHz$
Gain bandwidth product	$f_T$	6	9	—	GHz	$V_{CE} = 5 V, I_C = 20 mA$ $f = 1 GHz$
$S_{21}$ parameter	$ S_{21} ^2$	—	11.8	—	dB	$V_{CE} = 5 V, I_C = 20 mA$ $f = 1 GHz$
Power gain	PG	9.5	13	—	dB	$V_{CE} = 5 V, I_C = 20 mA$ $f = 900 MHz$
Noise figure	NF	—	1.1	1.9	dB	$V_{CE} = 5 V, I_C = 5 mA$ $f = 900 MHz$

Collector Power Dissipation Curve

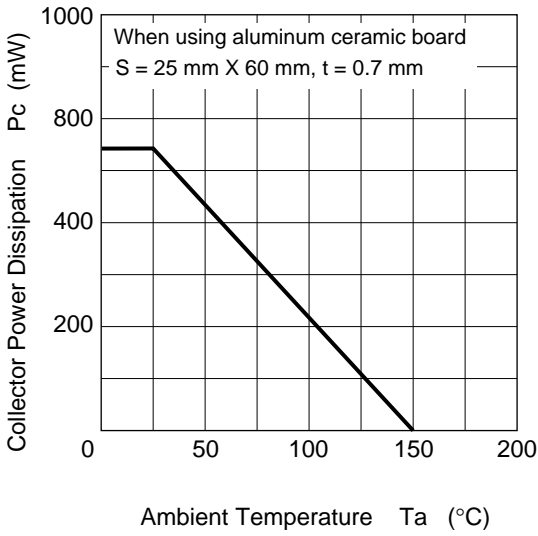

DC Current Transfet Ratio vs. Collector Current

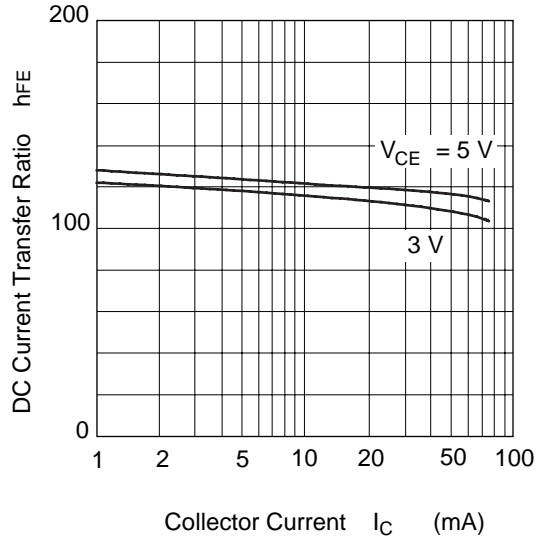

Collector Output Capacitance vs. Collector to Base Voltage

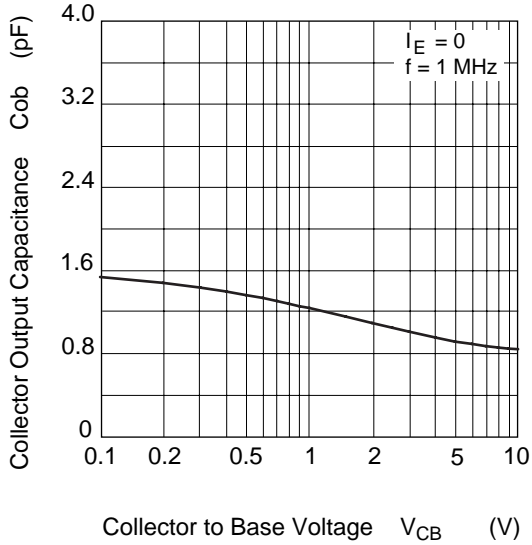

Gain Bandwidth Product vs. Collector Current

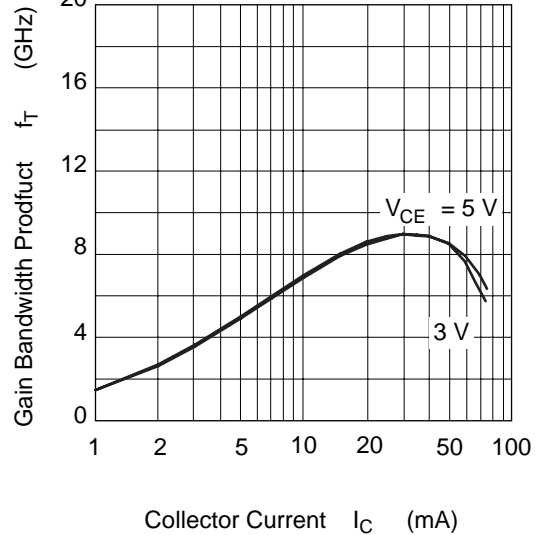

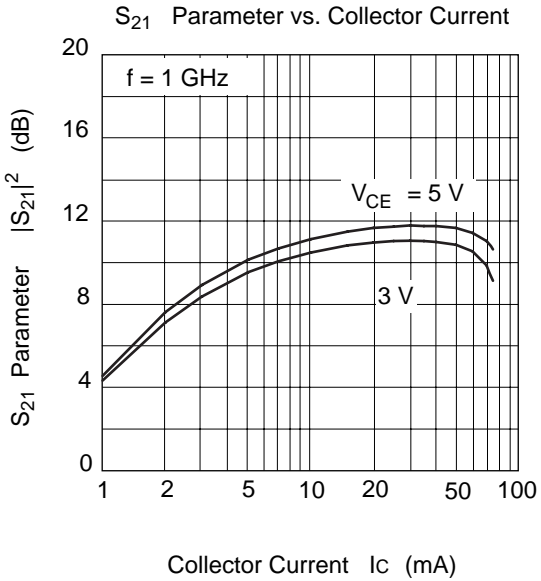
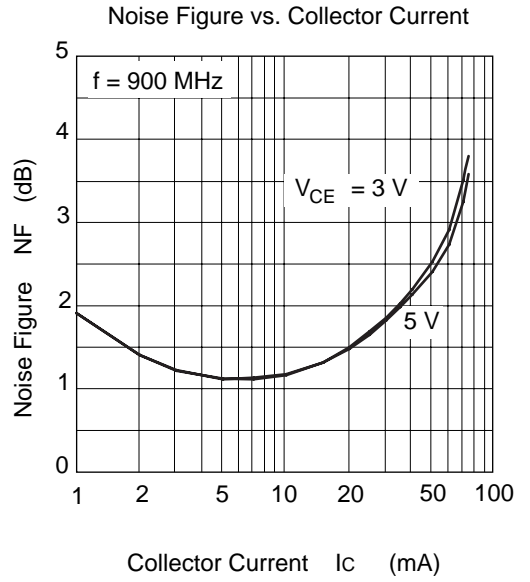
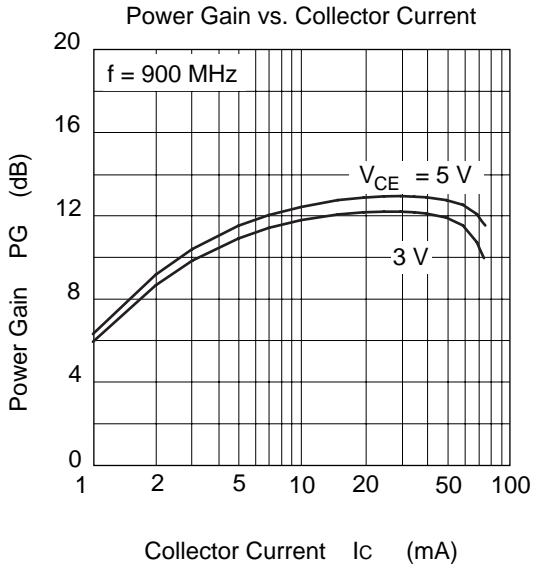

S11 Parameter vs. Frequency

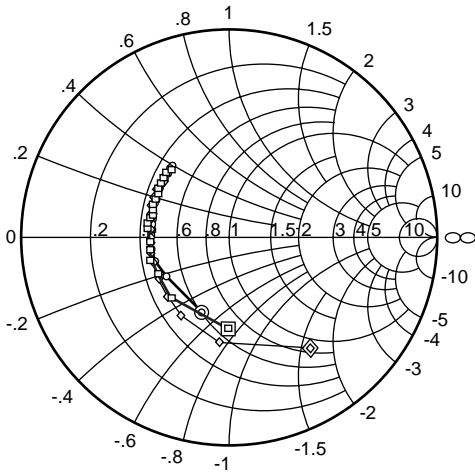

Condition:  $V_{CE} = 3\text{ V}$ ,  $Z_0 = 50\ \Omega$   
 100 to 2000 MHz (100 MHz Step)

- ( IC = 50 mA)
- ( IC = 30 mA)
- ◇ ( IC = 10 mA)

S21 Parameter vs. Frequency

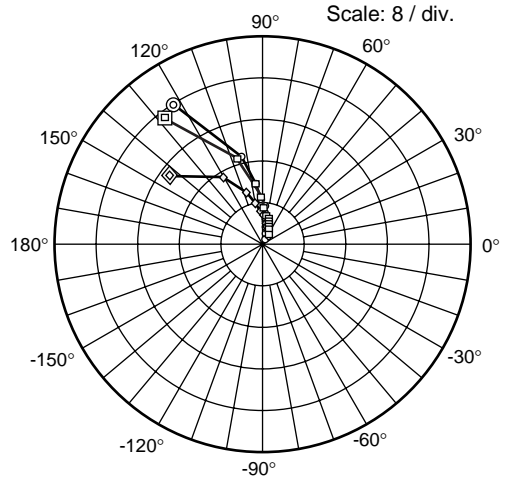

Condition:  $V_{CE} = 3\text{ V}$ ,  $Z_0 = 50\ \Omega$   
 100 to 2000 MHz (100 MHz Step)

- ( IC = 50 mA)
- ( IC = 30 mA)
- ◇ ( IC = 10 mA)

S12 Parameter vs. Frequency

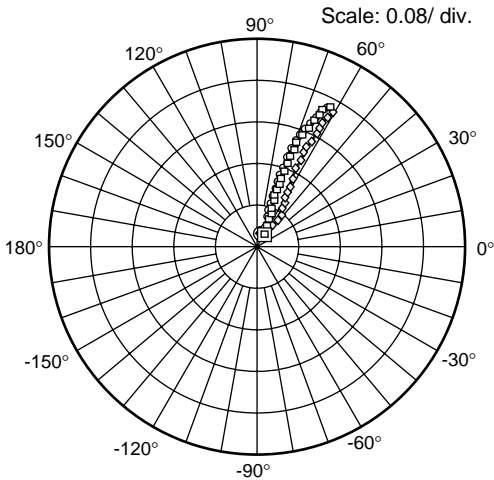

Condition:  $V_{CE} = 3\text{ V}$ ,  $Z_0 = 50\ \Omega$   
 100 to 2000 MHz (100 MHz Step)

- ( IC = 50 mA)
- ( IC = 30 mA)
- ◇ ( IC = 10 mA)

S22 Parameter vs. Frequency

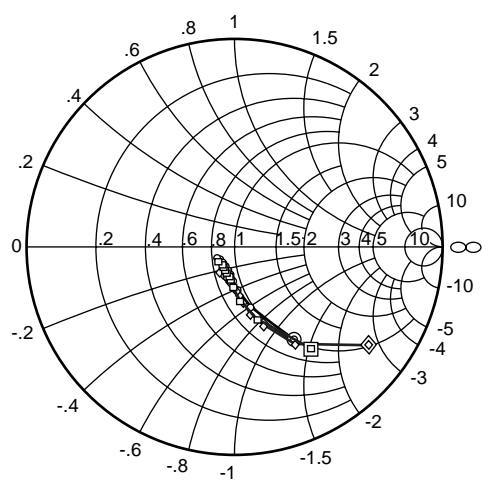

Condition:  $V_{CE} = 3\text{ V}$ ,  $Z_0 = 50\ \Omega$   
 100 to 2000 MHz (100 MHz Step)

- ( IC = 50 mA)
- ( IC = 30 mA)
- ◇ ( IC = 10 mA)

S11 Parameter vs. Frequency

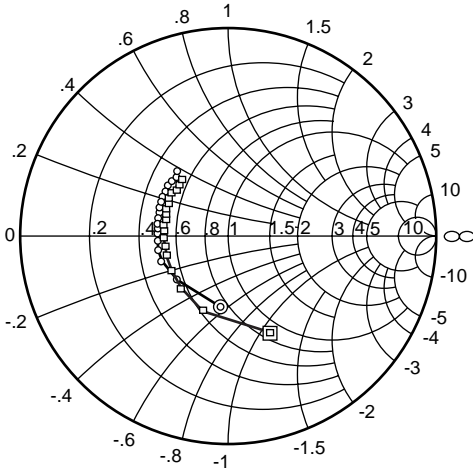

Condition:  $V_{CE} = 5\text{ V}$ ,  $Z_O = 50\ \Omega$   
 100 to 2000 MHz (100 MHz Step)  
 ○—○ (  $I_C = 50\text{ mA}$  )  
 □—□ (  $I_C = 20\text{ mA}$  )

S21 Parameter vs. Frequency

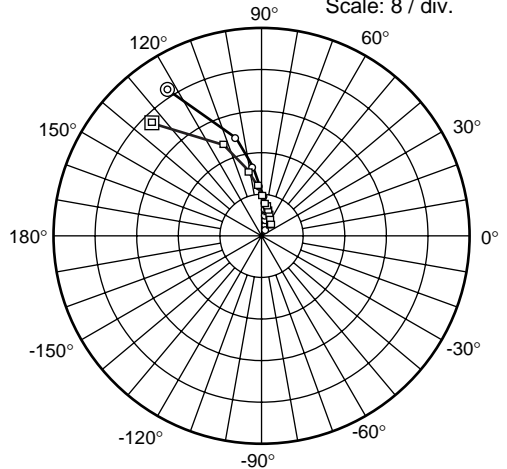

Condition:  $V_{CE} = 5\text{ V}$ ,  $Z_O = 50\ \Omega$   
 100 to 2000 MHz (100 MHz Step)  
 ○—○ (  $I_C = 50\text{ mA}$  )  
 □—□ (  $I_C = 20\text{ mA}$  )

S12 Parameter vs. Frequency

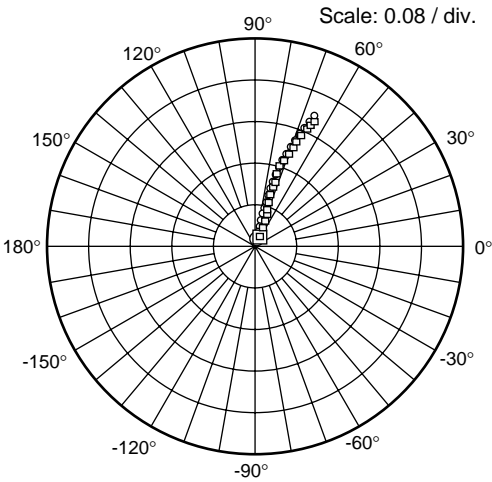

Condition:  $V_{CE} = 5\text{ V}$ ,  $Z_O = 50\ \Omega$   
 100 to 2000 MHz (100 MHz Step)  
 ○—○ (  $I_C = 50\text{ mA}$  )  
 □—□ (  $I_C = 20\text{ mA}$  )

S22 Parameter vs. Frequency

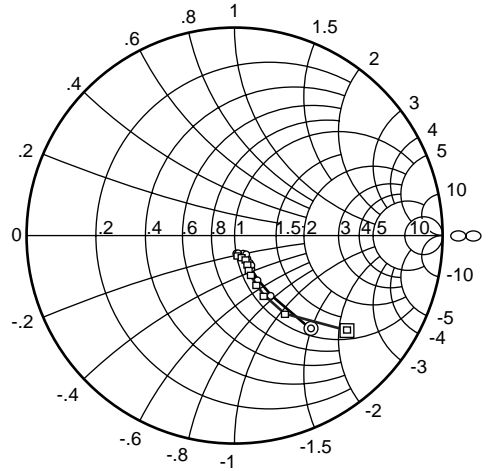

Condition:  $V_{CE} = 5\text{ V}$ ,  $Z_O = 50\ \Omega$   
 100 to 2000 MHz (100 MHz Step)  
 ○—○ (  $I_C = 50\text{ mA}$  )  
 □—□ (  $I_C = 20\text{ mA}$  )

Sparameter ( $V_{CE} = 3 \text{ V}$ ,  $I_C = 10 \text{ mA}$ ,  $Z_o = 50 \Omega$ )

f (MHz)	S11		S21		S12		S22	
	MAG	ANG	MAG	ANG	MAG	ANG	MAG	ANG
100	0.651	-53.8	21.22	142.8	0.035	65.6	0.802	-35.5
200	0.502	-93.8	14.62	120.0	0.054	56.9	0.554	-56.2
300	0.431	-119.6	10.48	107.6	0.067	56.0	0.401	-66.9
400	0.396	-136.4	8.09	99.8	0.079	56.9	0.317	-72.8
500	0.381	-149.9	6.57	94.2	0.091	58.9	0.263	-77.2
600	0.364	-158.7	5.54	89.7	0.103	60.3	0.227	-80.4
700	0.365	-167.2	4.78	85.9	0.116	61.6	0.201	-83.3
800	0.364	-174.6	4.22	82.5	0.128	62.5	0.183	-85.6
900	0.362	179.5	3.75	79.3	0.141	63.1	0.168	-88.3
1000	0.362	173.4	3.41	76.4	0.154	63.6	0.158	-90.2
1100	0.366	168.8	3.12	73.9	0.167	63.7	0.150	-92.7
1200	0.366	164.6	2.89	71.2	0.179	63.8	0.144	-95.0
1300	0.373	160.3	2.69	68.8	0.192	63.6	0.138	-97.0
1400	0.372	155.8	2.51	66.4	0.205	63.4	0.135	-99.0
1500	0.379	152.6	2.37	64.3	0.217	63.2	0.133	-101.7
1600	0.382	149.1	2.24	62.0	0.231	62.8	0.131	-103.7
1700	0.386	145.0	2.14	60.1	0.243	62.5	0.130	-106.0
1800	0.393	142.2	2.03	58.0	0.254	61.8	0.129	-108.2
1900	0.390	139.2	1.94	55.9	0.268	61.6	0.129	-110.5
2000	0.400	135.4	1.87	54.0	0.278	60.7	0.129	-112.1

**Sparameter** ( $V_{CE} = 3 \text{ V}$ ,  $I_C = 30 \text{ mA}$ ,  $Z_o = 50 \Omega$ )

<b>f (MHz)</b>	<b>S11</b>		<b>S21</b>		<b>S12</b>		<b>S22</b>	
	<b>MAG</b>	<b>ANG</b>	<b>MAG</b>	<b>ANG</b>	<b>MAG</b>	<b>ANG</b>	<b>MAG</b>	<b>ANG</b>
100	0.419	-90.2	30.42	127.3	0.026	63.9	0.608	-53.5
200	0.366	-132.9	17.49	107.6	0.040	64.4	0.357	-74.3
300	0.358	-151.9	11.80	98.6	0.055	67.0	0.247	-85.0
400	0.355	-163.8	8.88	93.1	0.070	69.5	0.193	-91.9
500	0.354	-173.3	7.14	89.0	0.085	70.6	0.162	-98.0
600	0.356	-178.8	5.97	85.5	0.100	71.5	0.141	-102.8
700	0.356	174.3	5.13	82.4	0.115	71.5	0.127	-107.4
800	0.364	169.5	4.51	79.6	0.130	71.4	0.117	-111.3
900	0.361	165.9	4.01	77.0	0.146	71.0	0.111	-114.9
1000	0.359	160.6	3.64	74.6	0.160	70.6	0.105	-118.5
1100	0.367	157.8	3.33	72.2	0.176	70.0	0.103	-121.5
1200	0.370	153.6	3.07	70.2	0.190	69.4	0.101	-124.5
1300	0.368	150.1	2.86	67.7	0.204	68.3	0.099	-127.0
1400	0.376	146.5	2.67	65.9	0.218	68.0	0.099	-129.3
1500	0.382	144.2	2.52	63.9	0.232	67.2	0.098	-131.8
1600	0.387	141.0	2.38	61.8	0.247	66.4	0.099	-133.9
1700	0.388	137.3	2.27	59.9	0.260	65.6	0.100	-135.8
1800	0.393	134.9	2.15	58.0	0.274	64.6	0.100	-138.0
1900	0.394	132.8	2.07	56.3	0.288	63.8	0.102	-139.9
2000	0.393	129.3	1.98	54.5	0.298	62.6	0.103	-140.6



Sparameter ( $V_{CE} = 3 \text{ V}$ ,  $I_C = 50 \text{ mA}$ ,  $Z_o = 50 \Omega$ )

f (MHz)	S11		S21		S12		S22	
	MAG	ANG	MAG	ANG	MAG	ANG	MAG	ANG
100	0.365	-111.0	31.77	122.3	0.023	65.4	0.530	-58.5
200	0.363	-147.7	17.40	104.2	0.037	68.1	0.299	-77.7
300	0.370	-162.8	11.60	96.2	0.052	71.0	0.207	-87.5
400	0.368	-172.3	8.71	91.0	0.068	72.8	0.163	-94.0
500	0.374	-179.4	6.97	87.3	0.083	73.4	0.137	-99.7
600	0.375	174.9	5.84	84.0	0.099	73.8	0.121	-104.7
700	0.378	170.4	5.02	81.2	0.114	73.6	0.110	-108.8
800	0.383	165.8	4.41	78.4	0.129	73.4	0.103	-112.5
900	0.381	161.7	3.91	76.0	0.146	72.7	0.099	-116.4
1000	0.384	157.4	3.55	73.3	0.161	72.4	0.095	-119.2
1100	0.389	153.7	3.25	71.2	0.177	71.6	0.093	-122.6
1200	0.394	150.4	3.00	69.0	0.190	70.7	0.092	-125.1
1300	0.395	147.3	2.80	66.7	0.204	69.7	0.091	-127.8
1400	0.398	144.1	2.61	64.8	0.219	69.2	0.092	-129.7
1500	0.407	141.7	2.46	62.9	0.233	68.2	0.092	-132.2
1600	0.410	139.0	2.33	60.8	0.248	67.4	0.093	-134.0
1700	0.407	135.2	2.21	59.0	0.262	66.5	0.095	-135.9
1800	0.414	133.5	2.10	57.2	0.275	65.5	0.096	-137.7
1900	0.412	130.3	2.02	55.0	0.289	64.8	0.098	-139.5
2000	0.423	127.6	1.93	53.1	0.300	63.6	0.099	-140.4

**Sparameter** ( $V_{CE} = 5 \text{ V}$ ,  $I_C = 20 \text{ mA}$ ,  $Z_o = 50 \Omega$ )

<b>f (MHz)</b>	<b>S11</b>		<b>S21</b>		<b>S12</b>		<b>S22</b>	
	<b>MAG</b>	<b>ANG</b>	<b>MAG</b>	<b>ANG</b>	<b>MAG</b>	<b>ANG</b>	<b>MAG</b>	<b>ANG</b>
100	0.505	-66.9	29.11	134.6	0.026	65.8	0.707	-40.5
200	0.381	-108.9	18.04	112.9	0.040	62.3	0.448	-57.3
300	0.337	-132.7	12.44	102.5	0.053	64.6	0.318	-63.3
400	0.320	-148.4	9.46	96.2	0.065	66.7	0.252	-65.8
500	0.311	-161.0	7.63	91.6	0.079	68.2	0.211	-67.2
600	0.305	-168.4	6.40	87.7	0.092	69.2	0.184	-67.9
700	0.308	-176.8	5.51	84.5	0.105	69.7	0.165	-68.5
800	0.306	177.7	4.84	81.4	0.119	70.1	0.152	-69.2
900	0.311	172.1	4.30	78.8	0.133	70.0	0.142	-70.5
1000	0.309	166.8	3.90	76.1	0.145	69.8	0.134	-71.1
1100	0.313	163.3	3.57	73.7	0.159	69.5	0.128	-72.7
1200	0.321	158.2	3.29	71.4	0.172	69.0	0.124	-74.2
1300	0.318	154.7	3.06	69.1	0.184	68.3	0.119	-75.5
1400	0.323	150.1	2.86	67.2	0.198	67.9	0.117	-77.2
1500	0.333	147.6	2.69	65.1	0.210	67.3	0.114	-79.1
1600	0.338	145.0	2.53	63.0	0.223	66.6	0.113	-80.9
1700	0.338	139.3	2.41	61.0	0.236	66.1	0.113	-83.2
1800	0.344	136.8	2.29	59.1	0.248	65.1	0.111	-85.5
1900	0.344	134.7	2.19	57.3	0.260	64.5	0.110	-88.0
2000	0.351	131.2	2.10	55.5	0.271	63.4	0.110	-89.6

Sparameter ( $V_{CE} = 5 \text{ V}$ ,  $I_C = 50 \text{ mA}$ ,  $Z_o = 50 \Omega$ )

f (MHz)	S11		S21		S12		S22	
	MAG	ANG	MAG	ANG	MAG	ANG	MAG	ANG
100	0.360	-99.4	34.20	124.3	0.020	66.9	0.567	-48.7
200	0.329	-139.8	19.03	105.6	0.034	68.2	0.330	-60.7
300	0.323	-157.8	12.76	97.1	0.047	71.6	0.233	-63.2
400	0.323	-168.1	9.58	92.1	0.061	73.6	0.186	-63.4
500	0.326	-176.6	7.69	88.2	0.075	74.1	0.160	-63.3
600	0.328	177.5	6.42	85.0	0.089	74.6	0.142	-63.4
700	0.326	172.1	5.51	82.0	0.103	74.4	0.131	-63.6
800	0.332	166.9	4.85	79.2	0.117	74.1	0.122	-63.9
900	0.335	163.3	4.30	76.9	0.131	73.6	0.116	-65.2
1000	0.336	159.3	3.90	74.3	0.145	73.3	0.112	-65.9
1100	0.338	155.0	3.56	72.2	0.158	72.4	0.108	-67.9
1200	0.349	151.7	3.28	69.9	0.172	72.0	0.106	-69.5
1300	0.347	148.8	3.05	67.9	0.185	71.0	0.103	-70.9
1400	0.350	144.3	2.85	65.9	0.198	70.4	0.102	-73.3
1500	0.360	142.0	2.67	64.0	0.210	69.7	0.101	-75.5
1600	0.362	139.2	2.52	62.1	0.224	68.7	0.101	-77.7
1700	0.361	135.3	2.40	60.1	0.237	67.9	0.101	-80.0
1800	0.373	133.4	2.28	58.1	0.249	66.9	0.101	-82.5
1900	0.366	130.6	2.19	56.3	0.262	66.2	0.101	-85.5
2000	0.383	127.4	2.10	54.6	0.272	65.2	0.102	-87.1

Package Dimensions

Unit: mm

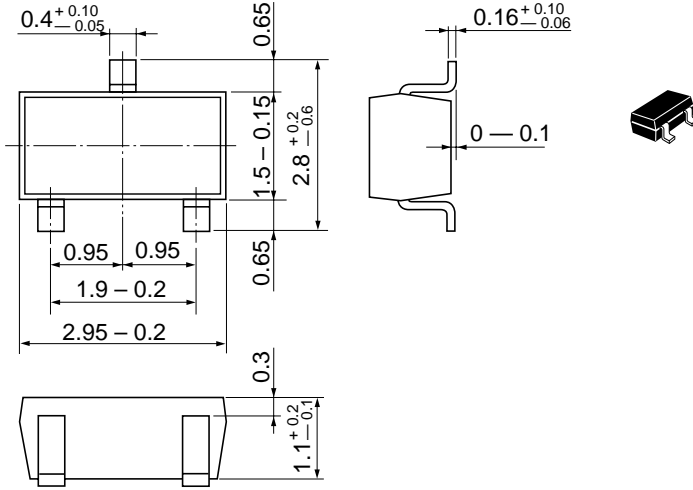

Hitachi Code	MPAK
JEDEC	
EIAJ	Conforms
Mass (reference value)	0.011 g

## Cautions

1. Hitachi neither warrants nor grants licenses of any rights of Hitachi's or any third party's patent, copyright, trademark, or other intellectual property rights for information contained in this document. Hitachi bears no responsibility for problems that may arise with third party's rights, including intellectual property rights, in connection with use of the information contained in this document.
2. Products and product specifications may be subject to change without notice. Confirm that you have received the latest product standards or specifications before final design, purchase or use.
3. Hitachi makes every attempt to ensure that its products are of high quality and reliability. However, contact Hitachi's sales office before using the product in an application that demands especially high quality and reliability or where its failure or malfunction may directly threaten human life or cause risk of bodily injury, such as aerospace, aeronautics, nuclear power, combustion control, transportation, traffic, safety equipment or medical equipment for life support.
4. Design your application so that the product is used within the ranges guaranteed by Hitachi particularly for maximum rating, operating supply voltage range, heat radiation characteristics, installation conditions and other characteristics. Hitachi bears no responsibility for failure or damage when used beyond the guaranteed ranges. Even within the guaranteed ranges, consider normally foreseeable failure rates or failure modes in semiconductor devices and employ systemic measures such as fail-safes, so that the equipment incorporating Hitachi product does not cause bodily injury, fire or other consequential damage due to operation of the Hitachi product.
5. This product is not designed to be radiation resistant.
6. No one is permitted to reproduce or duplicate, in any form, the whole or part of this document without written approval from Hitachi.
7. Contact Hitachi's sales office for any questions regarding this document or Hitachi semiconductor products.

# HITACHI

## Hitachi, Ltd.

Semiconductor & Integrated Circuits.  
Nippon Bldg., 2-6-2, Ohte-machi, Chiyoda-ku, Tokyo 100-0004, Japan  
Tel: Tokyo (03) 3270-2111 Fax: (03) 3270-5109

URL	North America	:	<a href="http://semiconductor.hitachi.com/">http://semiconductor.hitachi.com/</a>
	Europe	:	<a href="http://www.hitachi-eu.com/hel/ecg">http://www.hitachi-eu.com/hel/ecg</a>
	Asia	:	<a href="http://sicapac.hitachi-asia.com">http://sicapac.hitachi-asia.com</a>
	Japan	:	<a href="http://www.hitachi.co.jp/Sicd/indx.htm">http://www.hitachi.co.jp/Sicd/indx.htm</a>

### For further information write to:

Hitachi Semiconductor  
(America) Inc.  
179 East Tasman Drive,  
San Jose, CA 95134  
Tel: <1>(408) 433-1990  
Fax: <1>(408) 433-0223

Hitachi Europe Ltd.  
Electronic Components Group.  
Whitebrook Park  
Lower Cookham Road  
Maidenhead  
Berkshire SL6 8YA, United Kingdom  
Tel: <44> (1628) 585000  
Fax: <44> (1628) 585200

Hitachi Europe GmbH  
Electronic Components Group  
Dornacher Straße 3  
D-85622 Feldkirchen, Munich  
Germany  
Tel: <49> (89) 9 9180-0  
Fax: <49> (89) 9 29 30 00

Hitachi Asia Ltd.  
Hitachi Tower  
16 Collyer Quay #20-00,  
Singapore 049318  
Tel: <65>-538-6533/538-8577  
Fax: <65>-538-6933/538-3877  
URL: <http://www.hitachi.com.sg>

Hitachi Asia Ltd.  
(Taipei Branch Office)  
4/F, No. 167, Tun Hwa North Road,  
Hung-Kuo Building,  
Taipei (105), Taiwan  
Tel: <886>-(2)-2718-3666  
Fax: <886>-(2)-2718-8180  
Telex: 23222 HAS-TP  
URL: <http://www.hitachi.com.tw>

Hitachi Asia (Hong Kong) Ltd.  
Group III (Electronic Components)  
7/F., North Tower,  
World Finance Centre,  
Harbour City, Canton Road  
Tsim Sha Tsui, Kowloon,  
Hong Kong  
Tel: <852>-(2)-735-9218  
Fax: <852>-(2)-730-0281  
URL: <http://semiconductor.hitachi.com.hk>

Copyright © Hitachi, Ltd., 2001. All rights reserved. Printed in Japan.

Colophon 3.0

This datasheet has been download from:

[www.datasheetcatalog.com](http://www.datasheetcatalog.com)

Datasheets for electronics components.