

# K3640 • K3641

These Photocouplers consist of two Gallium Arsenide Infrared Emitting Diodes and a Silicon NPN PhotoDarlington transistor in a 6-pin package.

## FEATURES

- Collector-Emitter Voltage : Min.35V
- Current Transfer Ratio : Typ.500% (at  $I_F = \pm 1\text{mA}$ ,  $V_{CE} = 2\text{V}$ )
- Electrical Isolation Voltage : AC2500V<sub>rms</sub>
- Without Base Connection : K3640
- With Base Connection : K3641
- UL Recognized File No. E107486

## APPLICATIONS

- Interface between two circuits of different potential
- Telephone Line Receiver
- Automatic Vending Machine
- Power Supply Regulators

## DIMENSION

(Unit : mm)

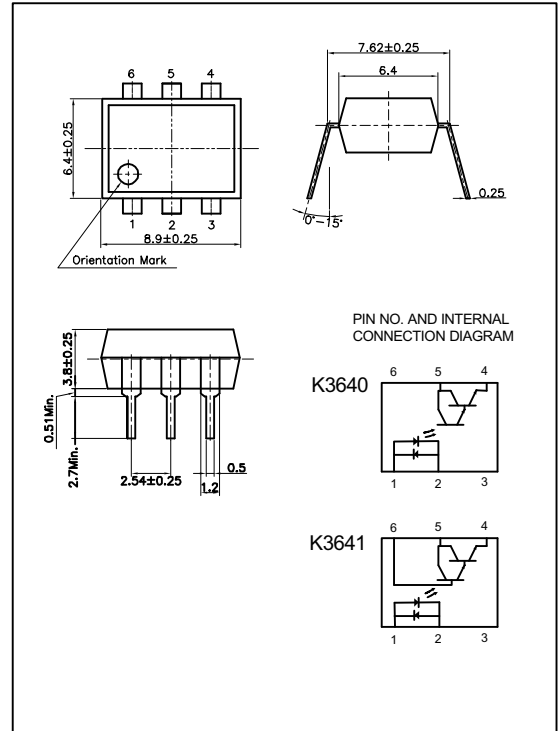

## MAXIMUM RATINGS

( $T_a = 25$  )

Parameter		Symbol	Rating	Unit
Input	Forward Current	$I_F$	$\pm 60$	mA
	Peak Forward Current <sup>*1</sup>	$I_{FP}$	$\pm 1$	A
	Power Dissipation	$P_D$	150	mW
	Junction Temperature	$T_J$	125	
Output	Collector-Emitter Breakdown Voltage	$BV_{CEO}$	35	V
	Emitter-Collector Breakdown Voltage	$BV_{ECO}$	6	V
	Collector-Base Breakdown Voltage <sup>**</sup>	$BV_{CBO}$	35	V
	Collector Current	$I_C$	50	mA
	Collector Power Dissipation	$P_C$	150	mW
Input to Output Isolation Voltage <sup>*2</sup>		$V_{iso}$	AC2500	V <sub>rms</sub>
Storage Temperature		$T_{stg}$	-55~+125	
Operating Temperature		$T_{opr}$	-30~+100	
Lead Soldering Temperature <sup>*3</sup>		$T_{sol}$	260	
Total Power Dissipation		$P_{tot}$	200	mW

\*\* Except for K3640

\*1. Input current with 100ms pulse width, 1% duty cycle

\*2. Measured at RH=40~60% for 1min

\*3. 1/16 inch form case for 10sec

## K3640 • K3641

### ELECTRO-OPTICAL CHARACTERISTICS

(Ta=25 °C, unless otherwise noted)

Parameter		Symbol	Condition	Min.	Typ.	Max.	Unit.
Input	Forward Voltage	V <sub>F</sub>	I <sub>F</sub> = ±10mA	-	1.15	1.30	V
	Capacitance	C <sub>T</sub>	V=0, f=1MHz	-	30	-	pF
Output	Collector-Emitter Breakdown Voltage	BV <sub>CEO</sub>	I <sub>C</sub> =1mA	35	-	-	V
	Emitter-Collector Breakdown Voltage	BV <sub>ECO</sub>	I <sub>E</sub> =0.1mA	6	-	-	V
	Collector-Base Breakdown Voltage **	BV <sub>CBO</sub>	I <sub>C</sub> =0.1mA	35	-	-	V
	Collector Dark Current	I <sub>CEO</sub>	I <sub>F</sub> =0, V <sub>CE</sub> =10V	-	-	100	nA
	Capacitance	C <sub>CE</sub>	V <sub>CE</sub> =0, f=1MHz	-	10	-	pF
Coupled	Current Transfer Ratio *4	CTR	I <sub>F</sub> = ±1mA, V <sub>CE</sub> =2V	-	500	-	%
	Collector-Emitter Saturation Voltage	V <sub>CE(SAT)</sub>	I <sub>F</sub> = ±1mA, I <sub>C</sub> =2mA	-	0.85	1.0	V
	Input-Output Capacitance	C <sub>IO</sub>	V=0, f=1MHz	-	1	-	pF
	Input-Output Isolation Resistance	R <sub>IO</sub>	RH=40~60%, V=500V	-	10 <sup>11</sup>	-	
	Rise Time	t <sub>r</sub>	V <sub>CE</sub> =10V, R <sub>L</sub> =100	-	100	-	
	Fall Time	t <sub>f</sub>	I <sub>C</sub> =2mA	-	100	-	

\*\* Except for K3640

\*4. CTR=(I<sub>C</sub>/I<sub>F</sub>) X 100 (%)

**K3640 • K3641**

**Forward Current vs. Ambient Temperature**

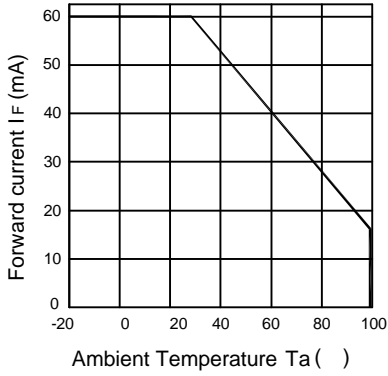

**Collector Power Dissipation vs. Ambient Temperature**

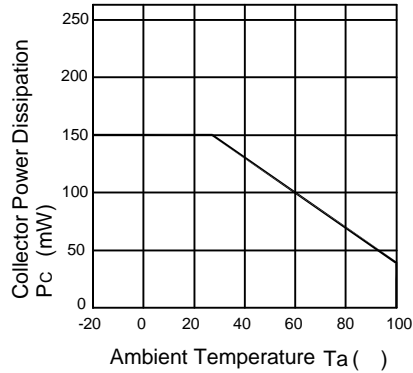

**Forward Current vs. Forward Voltage**

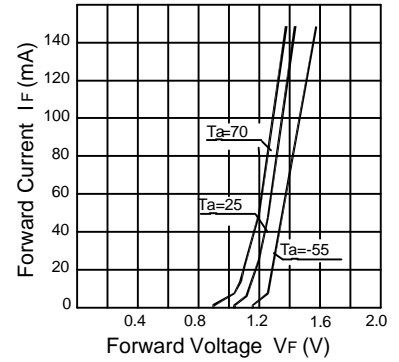

**Collector Current vs. Collector-Emitter Voltage**

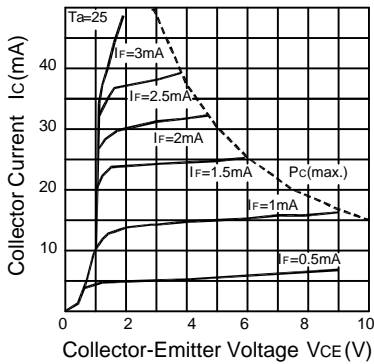

**Dark Current vs. Ambient Temperature**

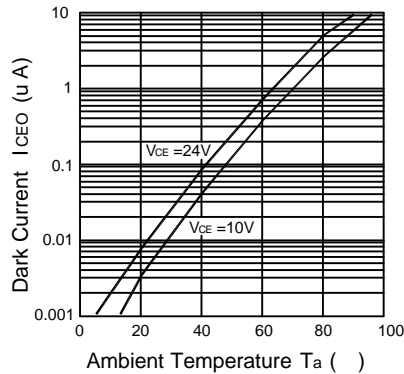

**Collector Current vs. Forward Current**

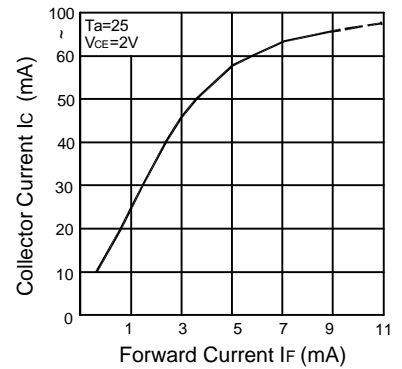

**Switching Time Test Circuit**

