

## GaAs MMIC LOW NOISE AMPLIFIER, 2.3 - 2.5 GHz

### Typical Applications

The HMC286 is ideal for:

- BlueTooth
- Home RF
- 802.11 WLAN Radios
- PCMCIA Platforms

### Functional Diagram

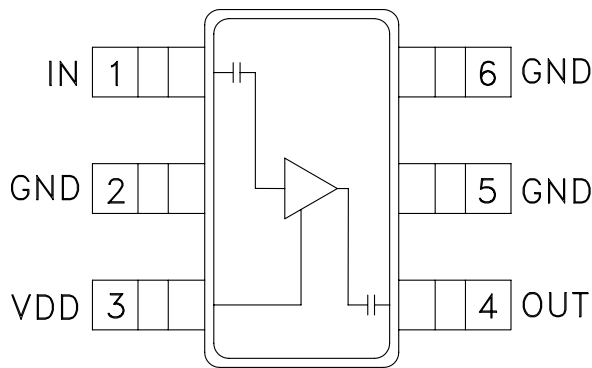

### Features

- 2.4 GHz LNA
- Noise Figure: 1.7 dB
- Gain: 19 dB
- Single Supply: +3V
- No External Components
- Ultra Small SOT26 Package

### General Description

The HMC286 is a low cost Low Noise Amplifier (LNA) for 2.3 to 2.5 GHz spread spectrum applications. The LNA provides 19 dB of gain and a 1.7 dB noise figure from a single positive +3V power supply that consumes only 8.5mA. The typical output 1 dB compression point is +6 dBm at 2.4 GHz. The compact LNA design utilizes on-chip matching for repeatable gain and noise figure performance. In addition, eliminating the external matching circuitry also reduces the overall size of the LNA function. The HMC286 was designed to meet the size constraints of PCMCIA platforms and uses the SOT26 package that occupies 0.118" x 0.118", which makes it a small fully integrated solution that can be easily implemented with other 2.4 GHz ASICs.

### Electrical Specifications, $T_A = +25^\circ C$ , $V_{dd} = +3V$

Parameter	Min.	Typ.	Max.	Units
Frequency Range	2.3 - 2.5			GHz
Gain	16	19		dB
Gain Variation Over Temperature		0.015	0.03	dB/°C
Gain Flatness		±1.25		dB
Noise Figure		1.7	2.5	dB
Input Return Loss		12		dB
Output Return Loss		4.5		dB
Output 1 dB Compression (P1dB)	2	6		dBm
Output Third Order Intercept (IP3)	9	12		dBm
Supply Current (I <sub>dd</sub> )		8.5	12.5	mA

## GaAs MMIC LOW NOISE AMPLIFIER, 2.3 - 2.5 GHz

**Broadband Gain & Return Loss**

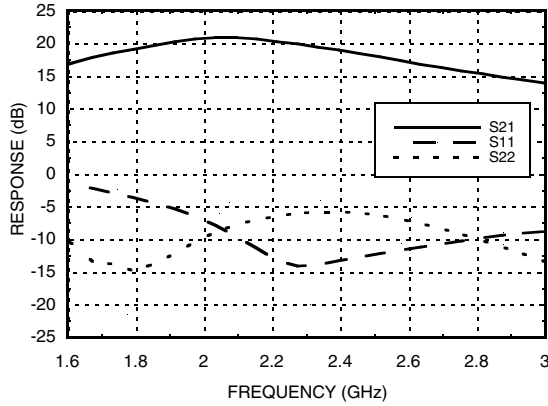

**Broadband Noise Figure**

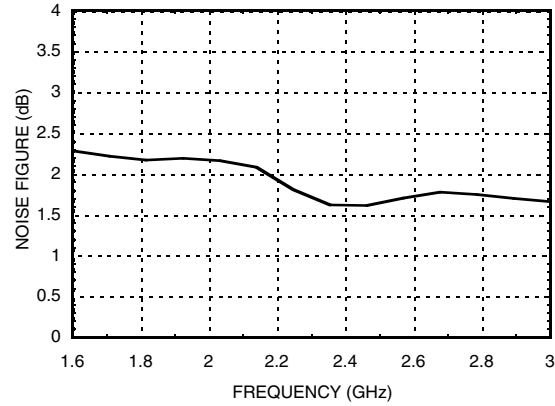

**Gain vs. Temperature**

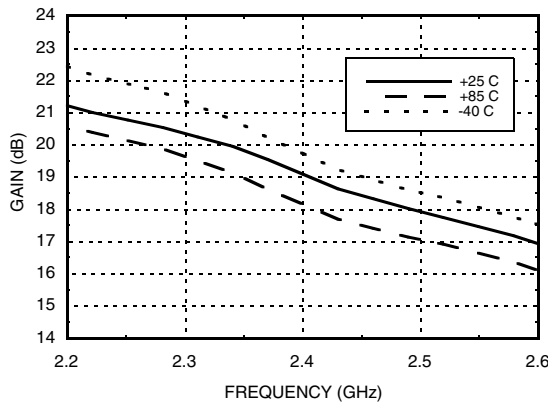

**Noise Figure vs. Temperature**

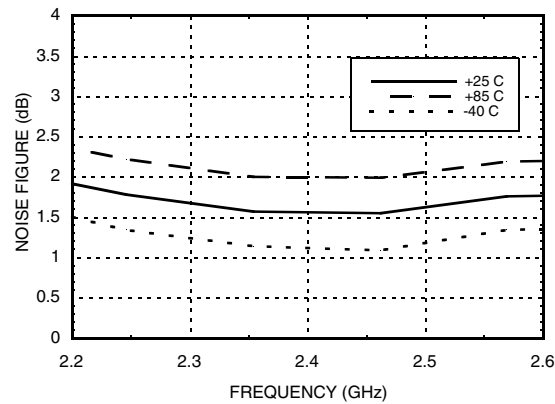

**Input Return Loss vs. Temperature**

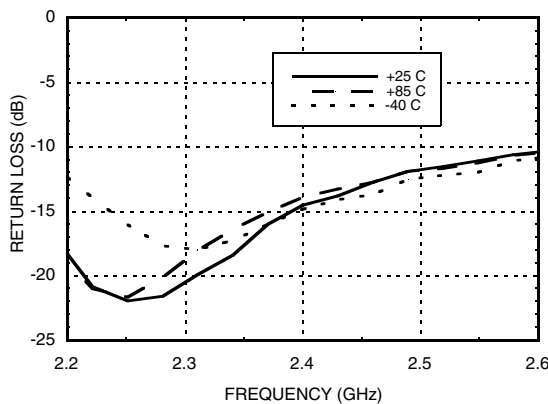

**Output Return Loss vs. Temperature**

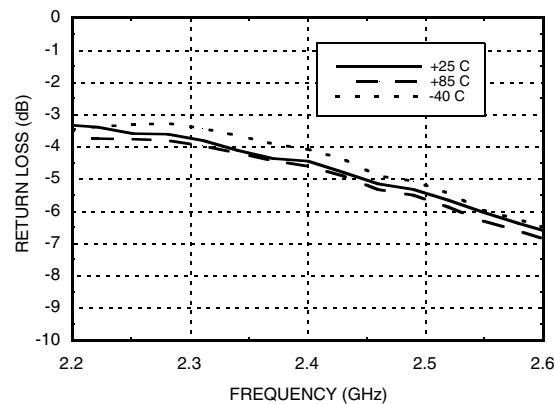

## GaAs MMIC LOW NOISE AMPLIFIER, 2.3 - 2.5 GHz

8

AMPLIFIERS - SMT

**Output P1dB vs. Temperature**

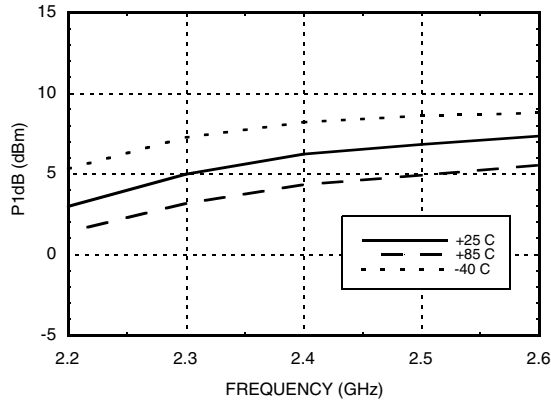

**Power Compression @ 2.4 GHz**

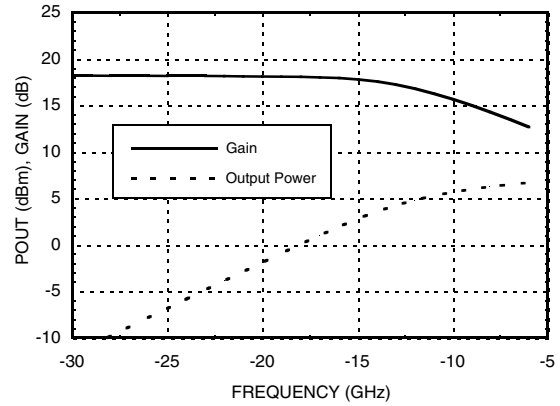

**Output IP3 vs. Temperature**

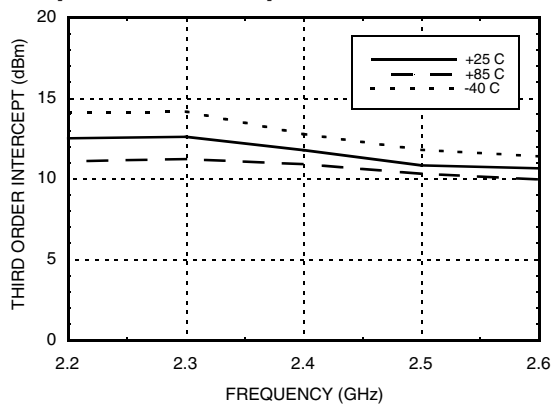

**Reverse Isolation vs. Temperature**

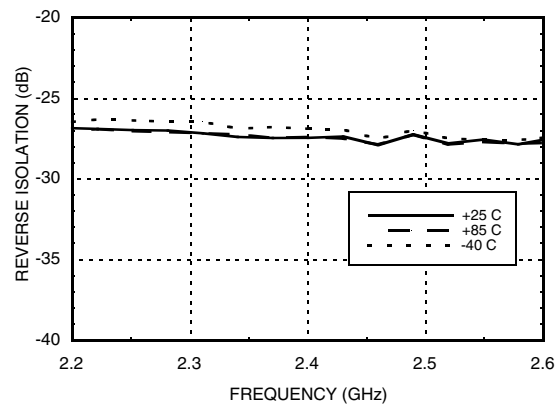

## GaAs MMIC LOW NOISE AMPLIFIER, 2.3 - 2.5 GHz

### Absolute Maximum Ratings

Drain Bias Voltage (Vdd)	+7.0 Vdc
RF Input Power (RFIn)(Vdd = +3.0 Vdc)	0 dBm
Channel Temperature	150 °C
Continuous Pdiss (T = 85 °C) (derate 6.35 mW/°C above 85 °C)	0.413 W
Thermal Resistance (channel to lead)	157 °C/W
Storage Temperature	-65 to +150 °C
Operating Temperature	-40 to +85 °C

### Outline Drawing

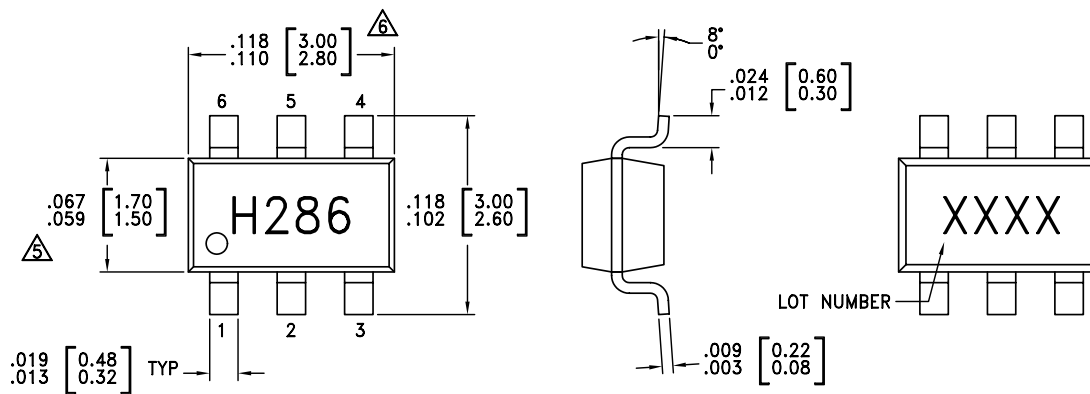





#### NOTES:

1. PACKAGE BODY MATERIAL: LOW STRESS INJECTION MOLDED PLASTIC SILICA AND SILICON IMPREGNATED.
2. LEADFRAME MATERIAL: COPPER ALLOY
3. LEADFRAME PLATING: Sn/Pb SOLDER
4. DIMENSIONS ARE IN INCHES [MILLIMETERS].
5. DIMENSION DOES NOT INCLUDE MOLDFLASH OF 0.15mm PER SIDE.
6. DIMENSION DOES NOT INCLUDE MOLDFLASH OF 0.25mm PER SIDE.
7. ALL GROUND LEADS MUST BE SOLDERED TO PCB RF GROUND.

## GaAs MMIC LOW NOISE AMPLIFIER, 2.3 - 2.5 GHz

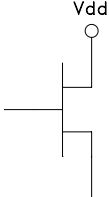
### Pad Descriptions

Pin Number	Function	Description	Interface Schematic
1	RFIN	This pin is AC coupled and matched to 50 Ohms.	
2, 5, 6	GND	These pins must be connected to RF/DC ground.	
3	VDD	Power supply voltage.	
4	RFOUT	This pin is AC coupled and matched to 50 Ohms.	

**GaAs MMIC LOW NOISE  
AMPLIFIER, 2.3 - 2.5 GHz**

**Evaluation PCB**

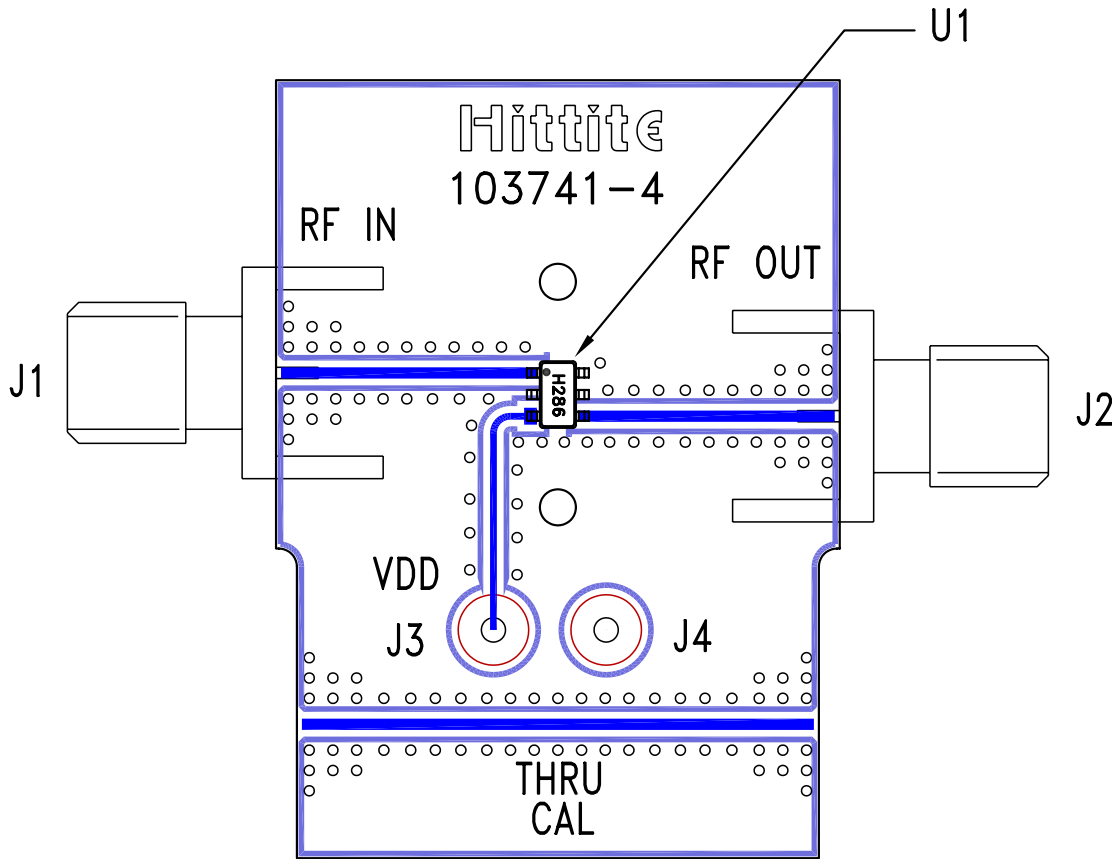

**List of Material for Evaluation PCB 103743\***

Item	Description
J1, J2	PC Mount SMA Connector
J3, J4	DC Pin
U1	HMC286 Amplifier
PCB**	103741 Eval Board
**Circuit Board Material: Roger 4350	

The circuit board used in the final application should use RF circuit design techniques. Signal lines should have 50 ohm impedance while the package ground leads should be connected directly to the ground plane similar to that shown above. A sufficient number of VIA holes should be used to connect the top and bottom ground planes. The evaluation circuit board shown is available from Hittite upon request.

\*Reference this number when ordering complete evaluation PCB.