



MOS FIELD EFFECT TRANSISTOR

**2SK654**

FAST SWITCHING  
N-CHANNEL SILICON POWER MOS FET

PACKAGE DIMENSIONS (Unit: mm)

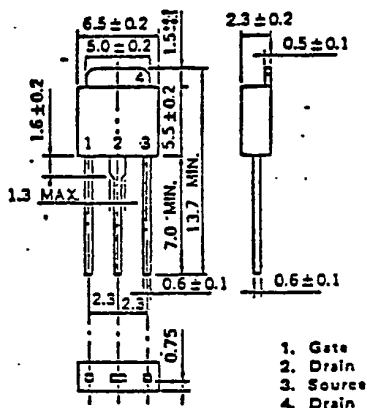

Features

- Suitable for switching power supplies, actuator controls and pulse circuits
- 4V Gate Drive — Logic Level —
- Low RDS(on)

Absolute Maximum Ratings(Ta=25°C)

Drain to Source Voltage	VDSS	100V
Gate to Source Voltage	VGSS	± 15V
Continuous Drain Current	ID(DC)	±1.0A
Pulse Drain Current	ID(pulse) *	±3.0A
Total Power Dissipation	PT	1.0W
Total Power Dissipation	PT**	10W
Channel Temperature	Tch	150 °C
Storage Temperature	Tstg	-55to+150 °C

\* PV ≤ 10 ms, Duty Cycle ≤ 50 %  
\*\* Tc=25 °C

Electrical Characteristics (Ta=25 °C)

Characteristics	Symbol	Min.	Typ.	Max.	Unit	Test Conditions
Drain Leakage Current	IDSS			10	μA	VDS=80 V, VGS=0
Gate to Source Leakage Current	IGSS			100	nA	VGS= 15V, VDS=0
Gate to Source Cutoff Voltage	VGS(off)	1.0		3.0	V	VDS=10V, ID=1.0mA
Forward Transfer Admittance	yfs	0.5			S	VDS=10V, ID=0.5A
Drain to Source On-State Resistance	RDS(on)		1.2	3.0	Ω	VGS=10V, ID=0.5A
Drain to Source On-State Resistance	RDS(on)		1.7	4.0	Ω	VGS=4.0V ID=0.2A
Input Capacitance	Ciss		120		pF	VDS= 10V, VGS=0,
Output Capacitance	Coss		70		pF	f=1.0MHz
Reverse Transfer Capacitance	Crss		24		pF	ID=0.5A
Turn-On Delay Time	td(on)		2		ns	VGS(on)= 10V,
Rise Time	tr		10		ns	Vcc=50 V,
Turn-Off Delay Time	td(off)		10		ns	RL=100 Ω
Fall Time	tf		5		ns	

K654

NEC ELECTRON DEVICE

TURN-ON AND TURN-OFF TIME TEST CIRCUIT

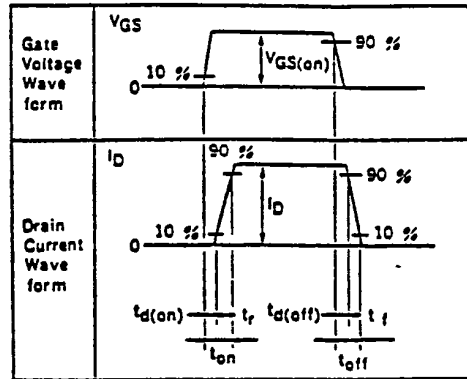
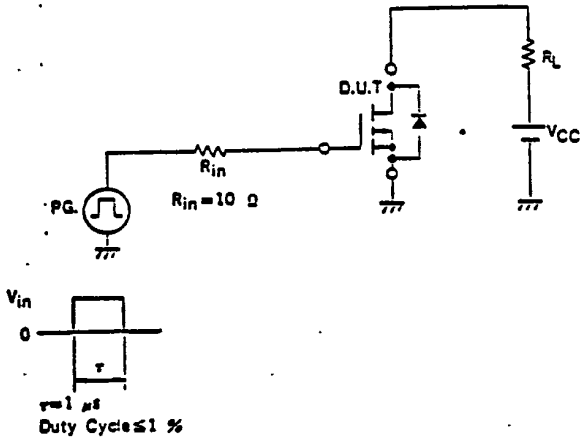

DERATING FACTOR OF FORWARD BIAS SAFE OPERATING AREA

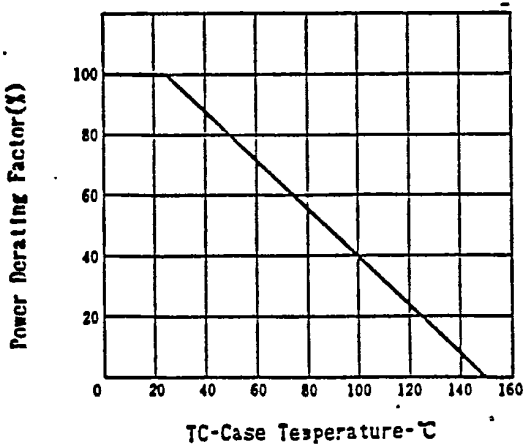

FORWARD BIAS SAFE OPERATING AREA

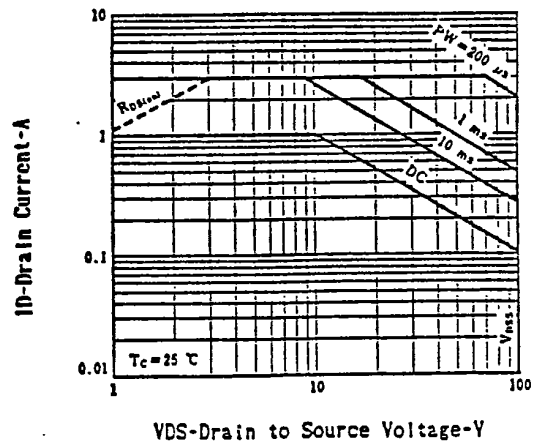

TOTAL POWER DISSIPATION vs. CASE TEMPERATURE

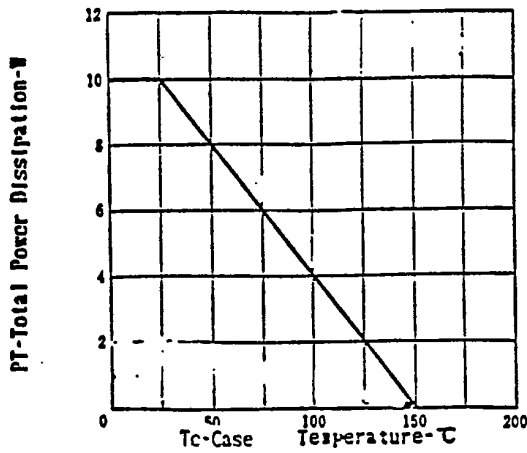

DRAIN CURRENT vs. DRAIN TO SOURCE VOLTAGE

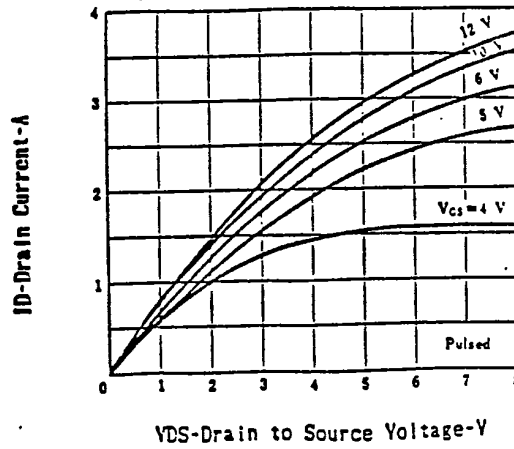

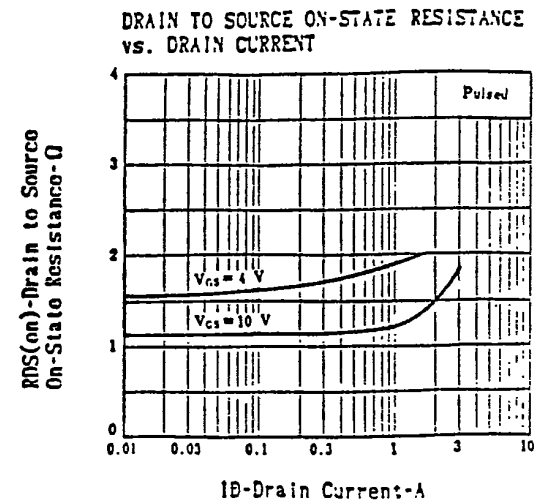
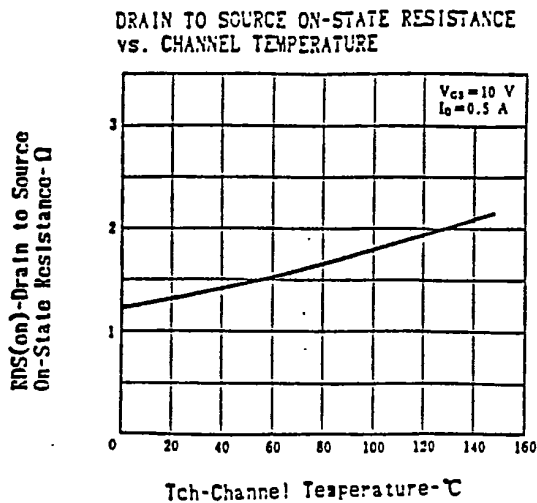
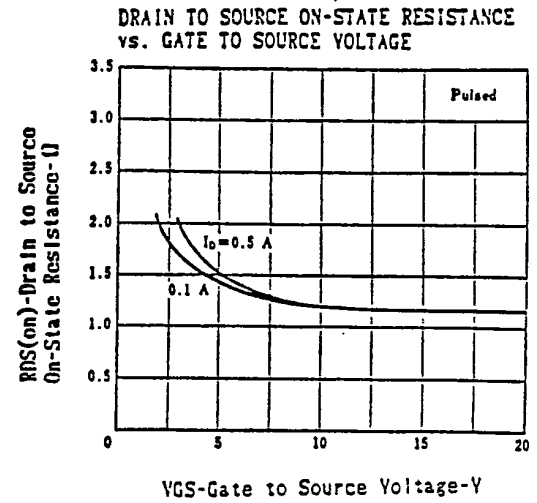
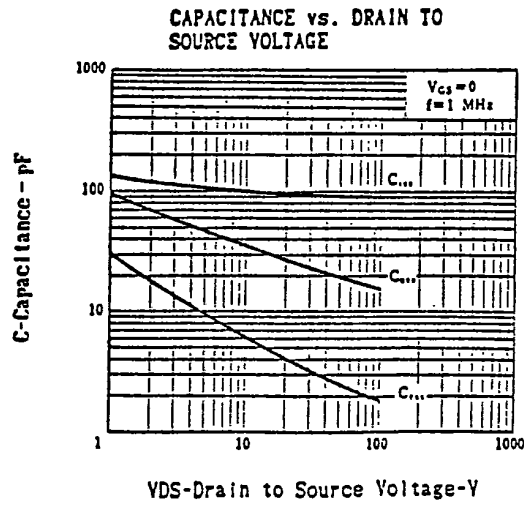
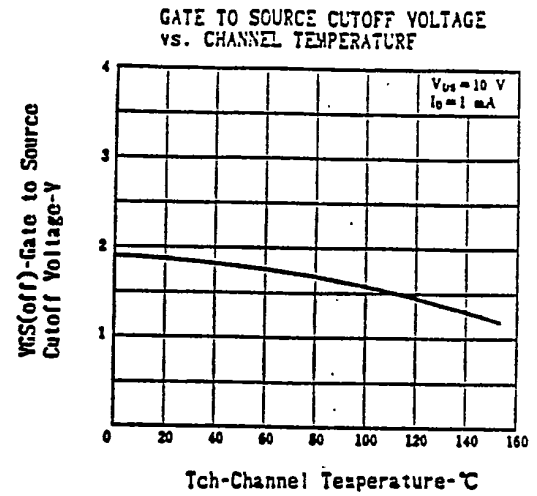
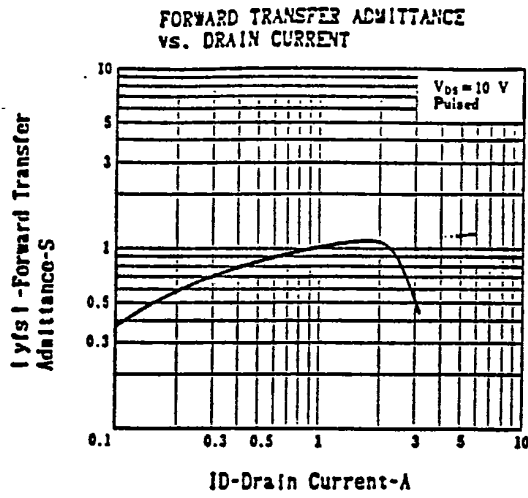

K672

NEC ELECTRON DEVICE

NEC ELECTRONICS INC.

98 DE 6427525 0018858 8

T-35-25

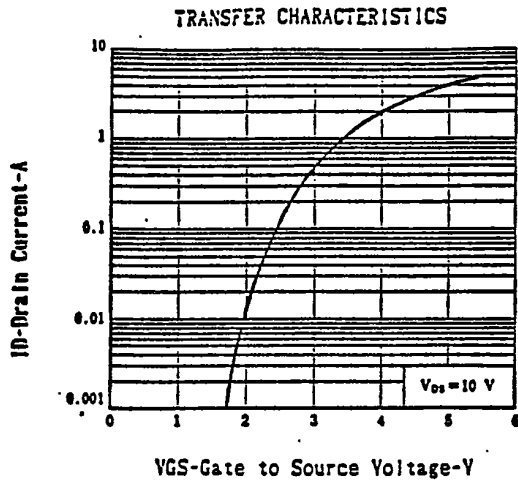

## NEC Corporation

INTERNATIONAL ELECTRON DEVICES DIV.  
NEC Building, 33-1, Shiba Gocho  
Minato-ku, Tokyo 108, Japan  
Tel: Tokyo 454-1111  
Telex Address: NECTOK J22686  
Cable Address: MICROPHONE TOKYO

Printed in Japan

4