

Precision 2.5V FGA™ Voltage Reference

X60008B-25
X60008C-25
X60008D-25

FEATURES

- Output Voltage: 2.500V
- Absolute Initial Accuracy Options: $\pm 0.5\text{mV}$ & $\pm 1.0\text{mV}$
- Ultra Low Power Supply Current: 500nA
- Low Temperature Coefficient options: 3, 5 & 10ppm/°C
- 10 mA Source & Sink Current Capability
- 10 ppm/1000hrs Long Term Stability
- Supply Voltage Range: 4.5V to 6.5V
- 5kV ESD (Human Body Model)
- Standard Package: SOIC-8
- Temp Range: -40°C to +85°C

DESCRIPTION

The X60008-25 FGA™ voltage references are very high precision analog voltage references fabricated in Xicor's proprietary Floating Gate Analog technology, which achieves superior levels of performance when compared to conventional band gap, buried zener, or XFET™ technologies.

FGA™ voltage references feature very high initial accuracy, very low temperature coefficient, excellent long term stability, low noise and excellent line and load regulation, at the lowest power consumption currently available. These voltage references enable advanced applications for precision industrial & portable systems operating at significantly higher accuracy and lower power levels than can be achieved with conventional technologies.

APPLICATIONS

- | | | |
|-------------------------------|------------------------------|-----------------------|
| • High Resolution A/Ds & D/As | • Precision Current Sources | • Smart sensors |
| • Digital Meters | • Precision Regulators | • Strain Gage Bridges |
| • Calibration Systems | • Precision Oscillators | • Threshold Detectors |
| • V-F Converters | • Battery Management Systems | • Servo Systems |

TYPICAL APPLICATION

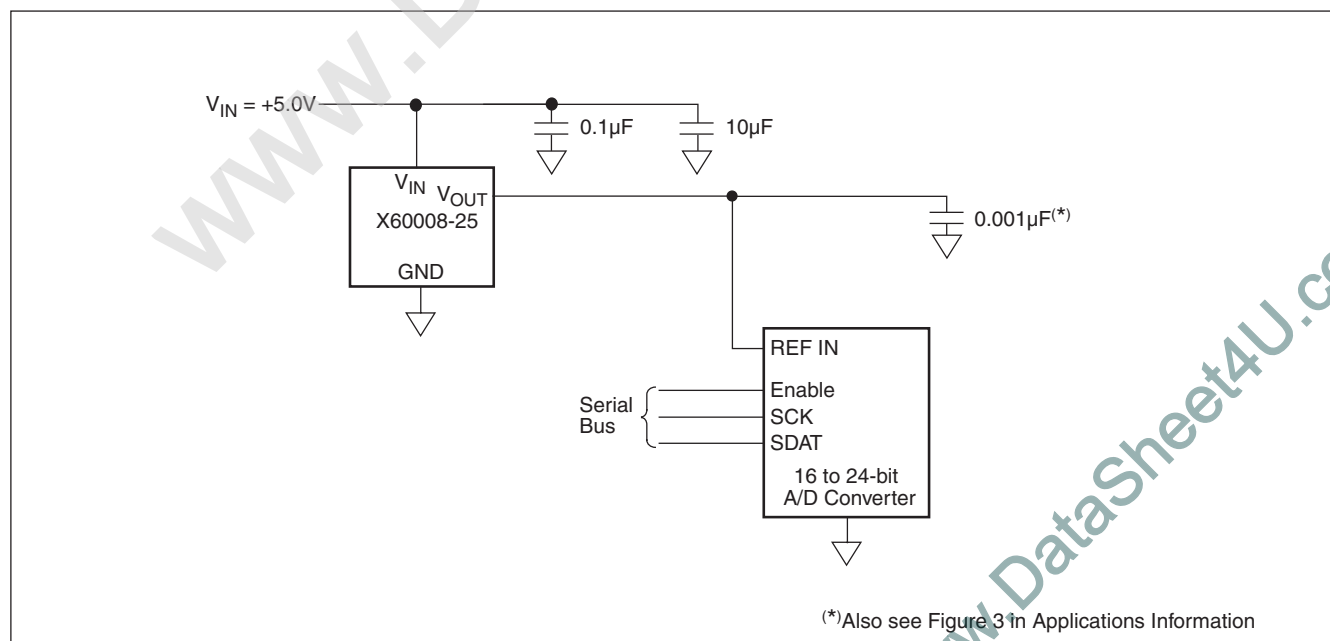

X60008B-25, X60008C-25, X60008D-25

PACKAGE DIAGRAM

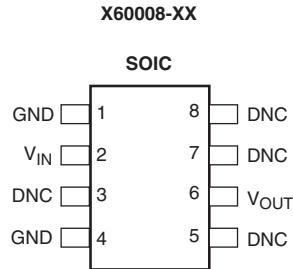

PIN CONFIGURATIONS

Pin Name	Description
GND	Ground Connection
V _{IN}	Power Supply Input Connection
V _{OUT}	Voltage Reference Output Connection
DNC	Do Not Connect; Internal Connection – Must Be Left Floating

ORDERING INFORMATION

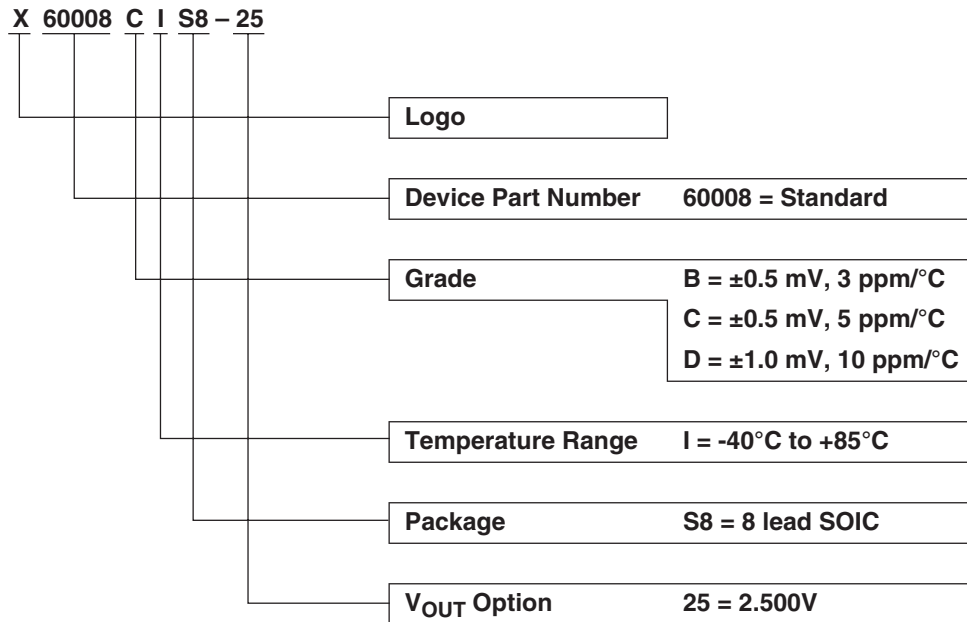

X60008B-25, X60008C-25, X60008D-25

ABSOLUTE MAXIMUM RATINGS

Storage Temperature Range -65°C to +125°C
 Max Voltage Applied V_{IN} to Gnd -0.5V to +6.5V
 Max Voltage Applied V_{OUT} to Gnd^(*) -0.5V to +3.5V
 Voltage on “DNC” pins No connections permitted to these pins.
 Lead Temperature, soldering^(*) + 225°C

(*) note: maximum duration = 10 seconds

COMMENT

Absolute Maximum Ratings are limits which may result in impaired reliability and/or permanent damage to the device. These are stress ratings provided for information only and functional operation of the device at these or any other conditions beyond those indicated in the operational sections of this specification are not implied.

RECOMMENDED OPERATING CONDITIONS

Temperature	Min.	Max.
Industrial	-40°C	+85°C

For guaranteed specifications and test conditions, see Electrical Characteristics.

The guaranteed specifications apply only for the test conditions listed. Some performance characteristics may degrade when the device is not operated under the listed test conditions.

ELECTRICAL CHARACTERISTICS

(Operating Conditions: $V_{IN} = 5.0V$, $I_{OUT} = 0mA$, $C_{OUT} = 0.001\mu F$, $T_A = -40$ to $+85^\circ C$ unless otherwise specified.)

Symbol	Parameter	Conditions	Min	Typ	Max	Units
V_{OUT}	Output Voltage			2.500		V
V_{OA}	V_{OUT} Accuracy X60008B-25 X60008C-25 X60008D-25	$T_A = 25^\circ C$	-0.50 -0.50 -1.00		+0.50 +0.50 +1.00	mV
I_{IN}	Supply Current			500	800	nA
V_{IN}	Input Voltage Range		4.5		6.5	V
TC V_{OUT}	Output Voltage Temperature Coefficient ⁽¹⁾	X60008B-25 X60008C-25 X60008D-25			3 5 10	ppm/ $^\circ C$
$\Delta V_{OUT}/\Delta V_{IN}$	Line Regulation	$+4.5V \leq V_{IN} \leq +6.5V$			100	$\mu V/V$
$\Delta V_{OUT}/\Delta I_{OUT}$	Load Regulation	$0mA \leq I_{SOURCE} \leq 10mA$ $-10mA \leq I_{SINK} \leq 0mA$		10 20	40 80	$\mu V/mA$
$\Delta V_{OUT}/\Delta t$	Long Term Stability	$T_A = 25^\circ C$		10		ppm/ 1000Hrs
$\Delta V_{OUT}/\Delta T_A$	Thermal Hysteresis ⁽²⁾	$\Delta T = -40^\circ C$ to $+85^\circ C$		50		ppm
I_{SC}	Short Circuit Current ⁽³⁾	$T_A = 25^\circ C$		50	80	mA
V_N	Output Voltage Noise	0.1Hz to 10Hz		30		μV_{pp}

- Note:**
- Over the specified temperature range. Temperature coefficient is measured by the box method whereby the change in V_{OUT} is divided by the temperature range; in this case, $-40^\circ C$ to $+85^\circ C = 125^\circ C$.
 - Thermal Hysteresis is the change in V_{OUT} created by package stress @ $T_A = 25^\circ C$ after temperature cycling. V_{OUT} is read initially at $T_A = 25^\circ C$; the X60008 is then cycled between Hot ($85^\circ C$) and Cold ($-40^\circ C$) before a second V_{OUT} measurement is taken at $25^\circ C$. The deviation between the initial V_{OUT} reading and the second V_{OUT} reading is then expressed in ppm.
 - Guaranteed by device characterization and/or correlation to other device tests.

X60008B-25, X60008C-25, X60008D-25

TYPICAL PERFORMANCE CHARACTERISTIC CURVES

($V_{IN} = 5.0V$, $I_{OUT} = 0mA$, $T_A = 25^\circ C$ unless otherwise specified)

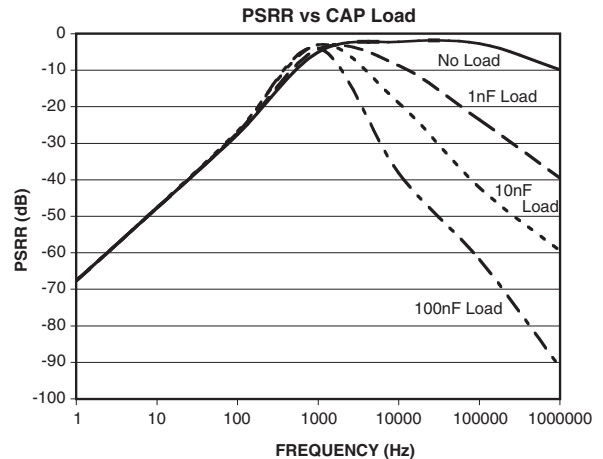
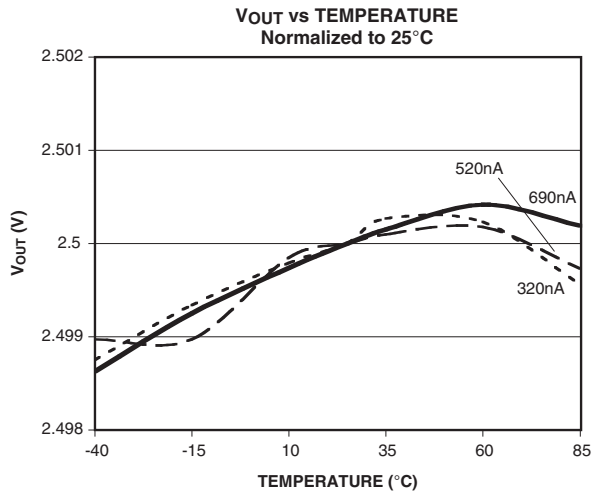
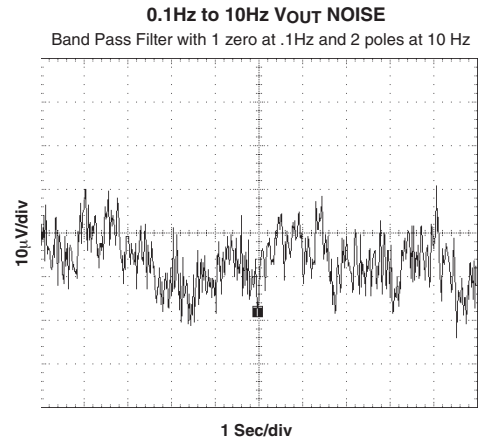
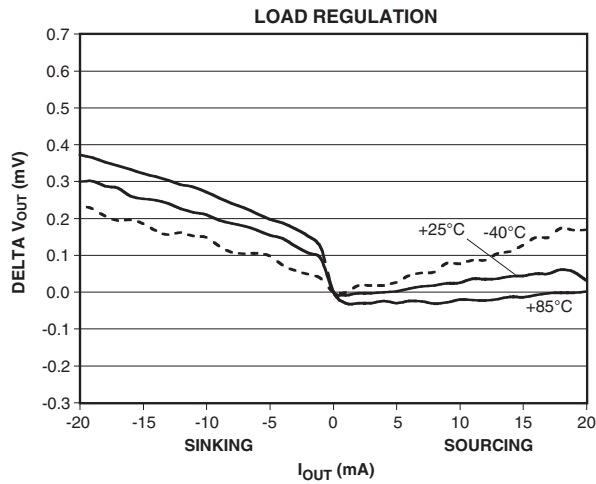
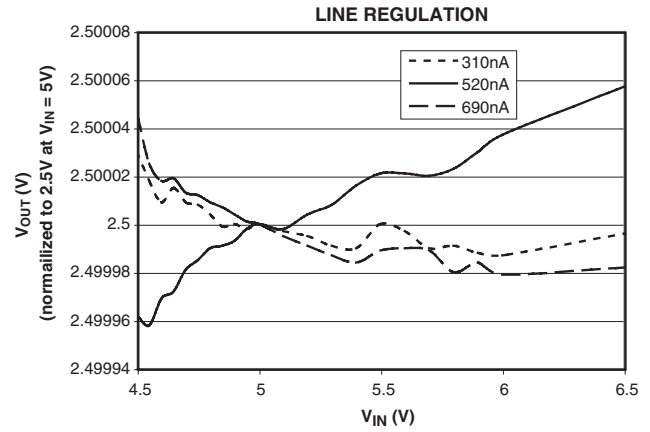
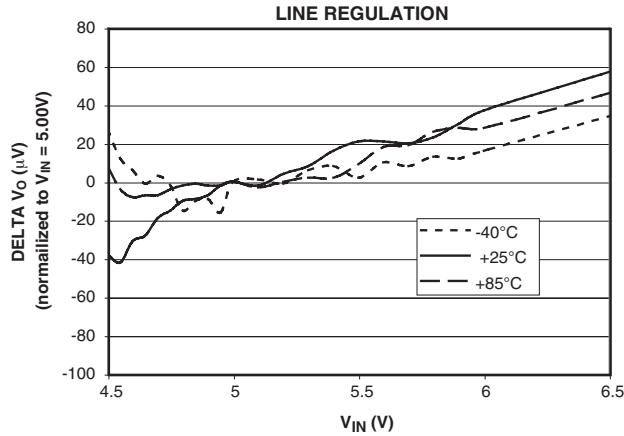

X60008B-25, X60008C-25, X60008D-25

TYPICAL PERFORMANCE CHARACTERISTIC CURVES

($V_{IN} = 5.0V$, $I_{OUT} = 0mA$, $T_A = 25^\circ C$ unless otherwise specified)

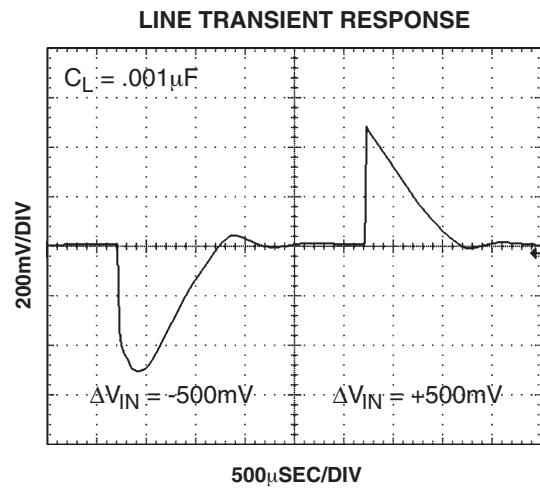
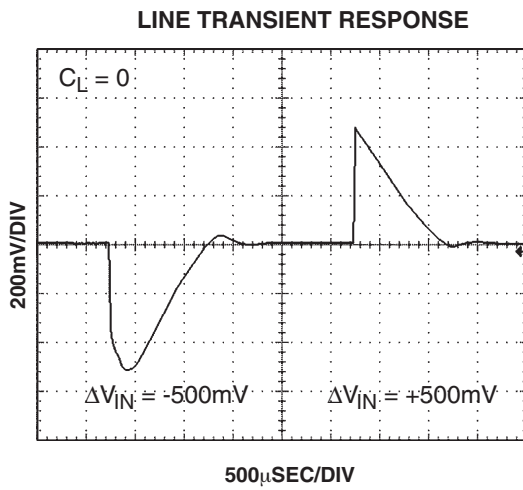
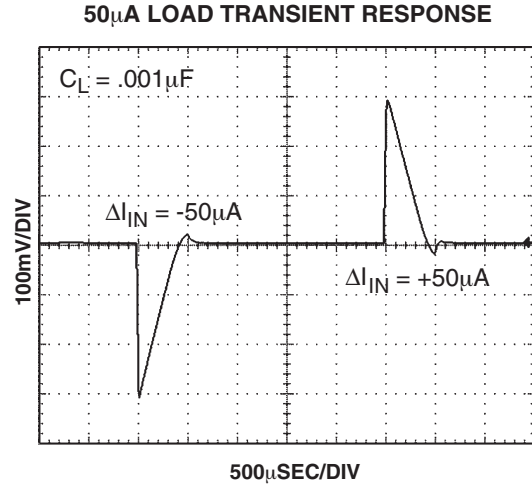
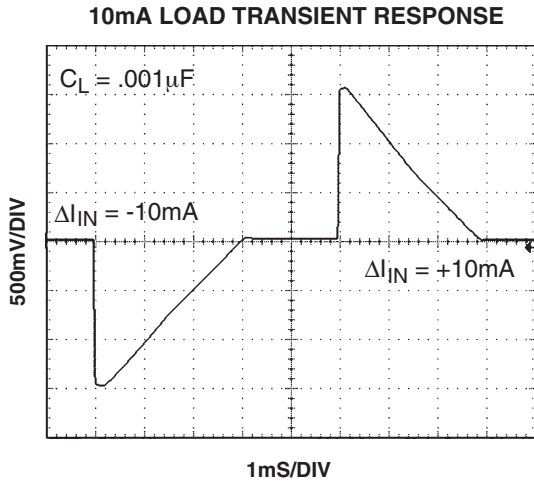

TYPICAL PERFORMANCE CHARACTERISTIC CURVES

($V_{IN} = 5.0V$, $I_{OUT} = 0mA$, $T_A = 25^\circ C$ unless otherwise specified)

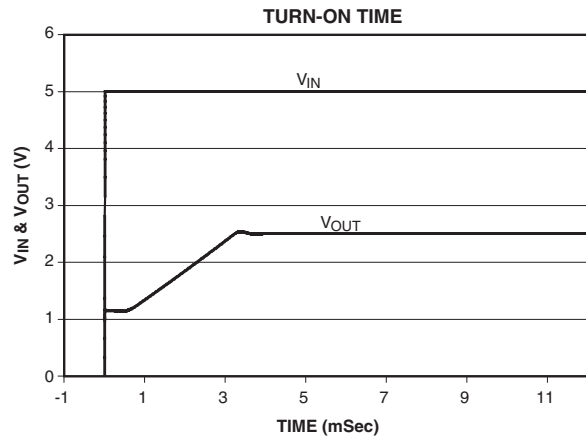
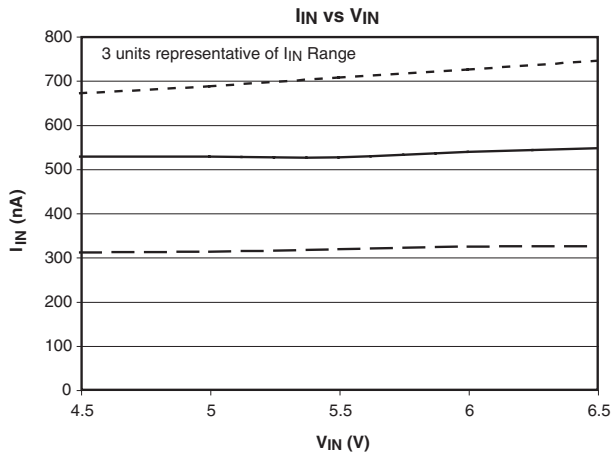
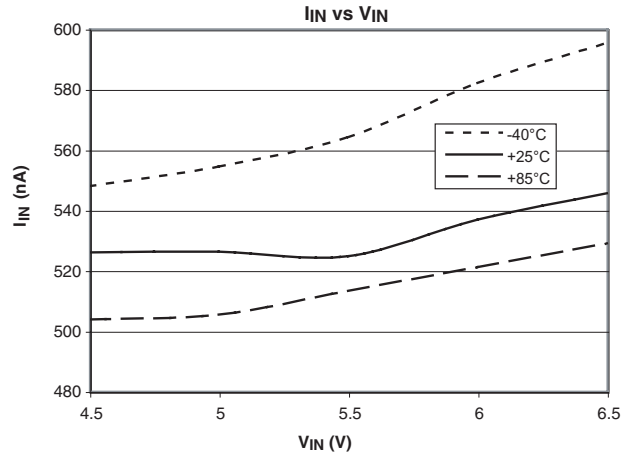
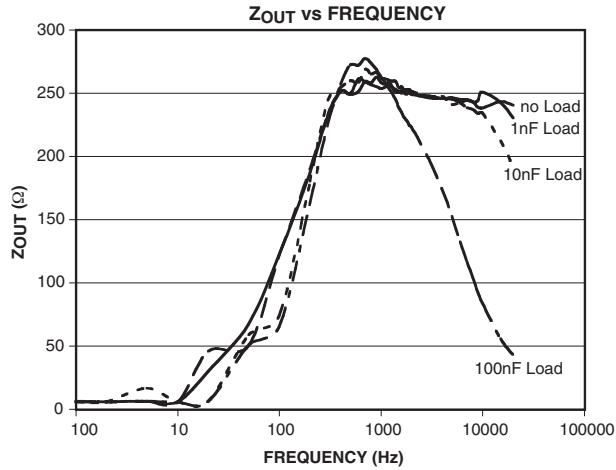

APPLICATIONS INFORMATION

FGA Technology

The X60008 series of voltage references use the floating gate technology to create references with very low drift and supply current. Essentially the charge stored on a floating gate cell is set precisely in manufacturing. The reference voltage output itself is a buffered version of the floating gate voltage. The resulting reference device has excellent characteristics which are unique in the industry: very low temperature drift, high initial accuracy, and almost zero supply current. Also, the reference voltage itself is not limited by voltage bandgaps or zener settings, so a wide range of reference voltages can be programmed (standard voltage settings are provided, but customer-specific voltages are available).

The process used for these reference devices is a floating gate CMOS process, and the amplifier circuitry uses CMOS transistors for amplifier and output transistor circuitry. While providing excellent accuracy, there are limitations in output noise level and load regulation due to the MOS device characteristics. These limitations are addressed with circuit techniques discussed in other sections.

Nanopower Operation

Reference devices achieve their highest accuracy when powered up continuously, and after initial stabilization has taken place. This drift can be eliminated by leaving the power on continuously.

The X60008 is the first high precision voltage reference with ultra low power consumption that makes it possible to leave power on continuously in battery operated circuits. The X60008 consumes extremely low supply current due to the proprietary FGA technology. Supply current at room temperature is typically 500nA which is 1 to 2 orders of magnitude lower than competitive devices. Application circuits using battery power will benefit greatly from having an accurate, stable reference which essentially presents no load to the battery.

In particular, battery powered data converter circuits that would normally require the entire circuit to be disabled when not in use can remain powered up between conversions as shown in figure 1. Data acquisition circuits providing 12 to 24 bits of accuracy can

operate with the reference device continuously biased with no power penalty, providing the highest accuracy and lowest possible long term drift.

Other reference devices consuming higher supply currents will need to be disabled in between conversions to conserve battery capacity. Absolute accuracy will suffer as the device is biased and requires time to settle to its final value, or, may not actually settle to a final value as power on time may be short.

Figure 1.

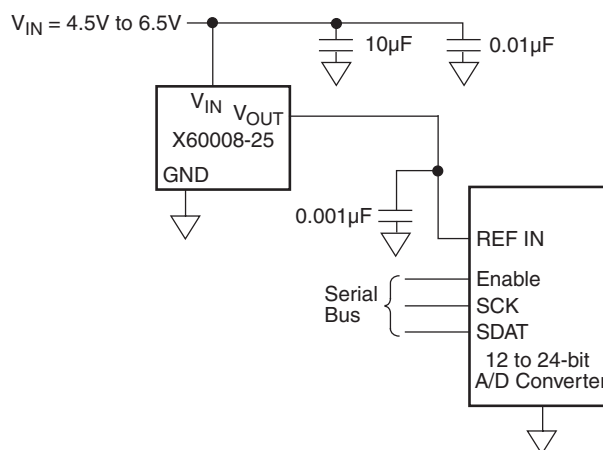

Board mounting Considerations

For applications requiring the highest accuracy, board mounting location should be reviewed. Placing the device in areas subject to slight twisting can cause degradation of the accuracy of the reference voltage due to die stresses. It is normally best to place the device near the edge of a board, or the shortest side, as the axis of bending is most limited at that location. Obviously mounting the device on flexprint or extremely thin PC material will likewise cause loss of reference accuracy.

Noise Performance and Reduction:

The output noise voltage in a 0.1Hz to 10Hz bandwidth is typically 30µVp-p. This is shown in the plot in the Typical Performance Curves. The noise measurement is made with a bandpass filter made of a 1 pole high-pass filter with a corner frequency at .1Hz and a 2-pole low-pass filter with a corner frequency at 12.6Hz to create a filter with a 9.9Hz bandwidth. Noise in the 10KHz to 1MHz bandwidth is approximately 400µVp-p with no capacitance on the output, as shown in Fig. 2 below. These noise measurements are made with a 2 decade bandpass filter made of a 1 pole high-pass

filter with a corner frequency at 1/10 of the center frequency and 1-pole low-pass filter with a corner frequency at 10 times the center frequency. Figure 2 also shows the noise in the 10KHz to 1MHz band can be reduced to about 50 μ Vp-p using a .001 μ F capacitor on the output. Noise in the 1KHz to 100KHz band can be further reduced using a 0.1 μ F capacitor on the output, but noise in the 1Hz to 100Hz band increases due to instability of the very low power amplifier with a 0.1 μ F capacitance load. For load capacitances above .001 μ F the noise reduction network shown in fig. 3 is recommended. This network reduces noise significantly over the full bandwidth. As shown in fig. 2, noise is reduced to less than 40 μ Vp-p from 1Hz to 1MHz using this network with a .01 μ F capacitor and a 2Kohm resistor in series with a 10 μ F capacitor.

Figure 2.

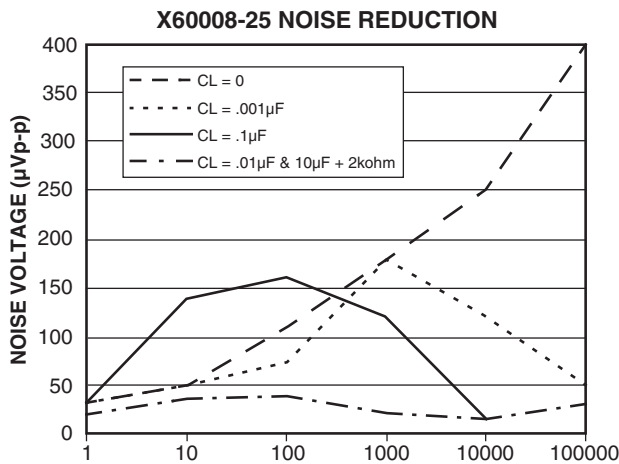
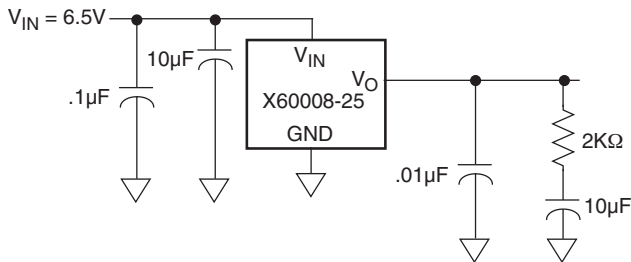

Figure 3.



Turn-On Time

The X60008 devices have ultra-low supply current and thus the time to bias up internal circuitry to final values will be longer than with higher power references. Normal turn-on time is typically 7ms. This is shown in the graph, Figure 4. Since devices can vary in supply current down to 300nA, turn-on time can last up to about 12ms. Care should be taken in system design to include this delay before measurements or conversions are started.

Figure 4.

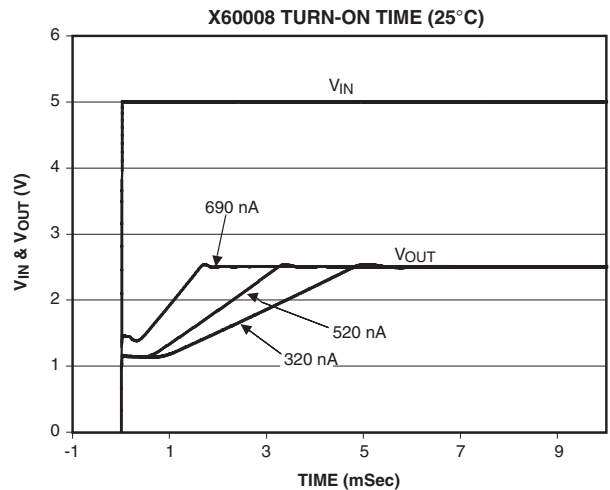

Temperature Coefficient

The limits stated for temperature coefficient (tempco) are governed by the method of measurement. The overwhelming standard for specifying the temperature drift of a reference is to measure the reference voltage at two temperatures, take the total variation, ($V_{HIGH} - V_{LOW}$), and divide by the temperature extremes of measurement ($T_{HIGH} - T_{LOW}$). The result is divided by the nominal reference voltage (at $T=25^{\circ}C$) and multiplied by 10^6 to yield ppm/ $^{\circ}C$. This is the "Box" method.

TYPICAL APPLICATION CIRCUITS

Precision 2.5V, 50mA Reference.

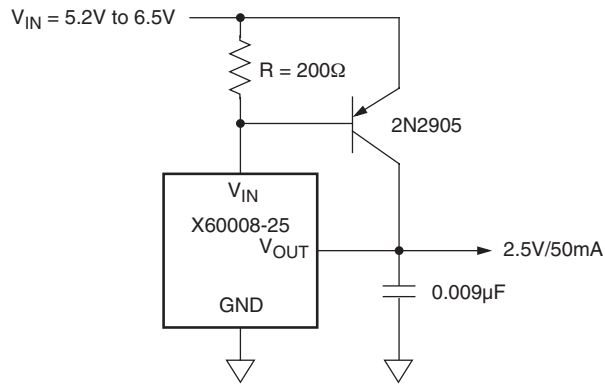

Kelvin Sensed Load

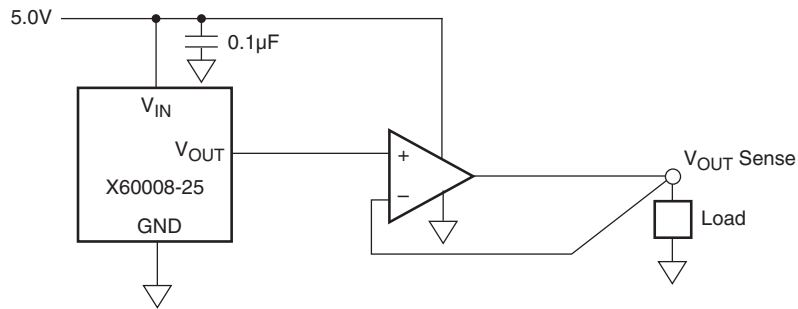

2.5V Full Scale Low-Drift 10-bit Adjustable Voltage Source

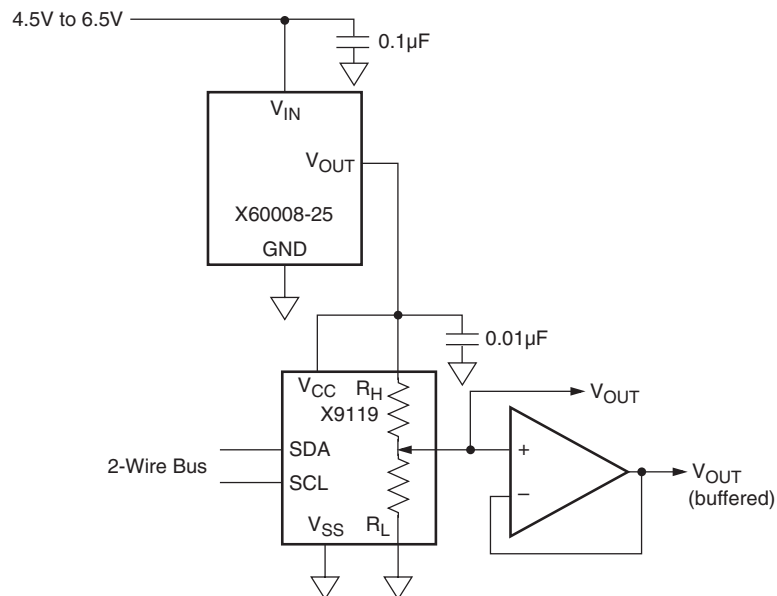

X60008B-25, X60008C-25, X60008D-25

PACKAGING INFORMATION

8-Lead Plastic, SOIC, Package Code S8

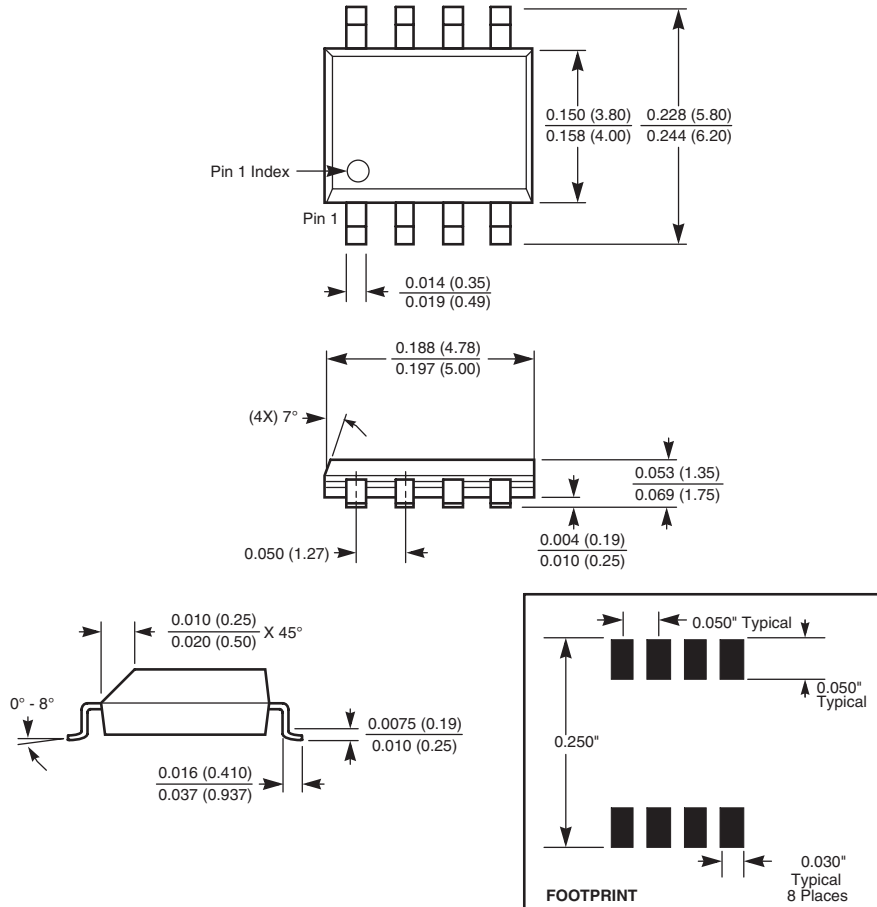

NOTE: ALL DIMENSIONS IN INCHES (IN PARENTHESES IN MILLIMETERS)

LIMITED WARRANTY

©Xicor, Inc. 2004 Patents Pending

Devices sold by Xicor, Inc. are covered by the warranty and patent indemnification provisions appearing in its Terms of Sale only. Xicor, Inc. makes no warranty, express, statutory, implied, or by description regarding the information set forth herein or regarding the freedom of the described devices from patent infringement. Xicor, Inc. makes no warranty of merchantability or fitness for any purpose. Xicor, Inc. reserves the right to discontinue production and change specifications and prices at any time and without notice.

Xicor, Inc. assumes no responsibility for the use of any circuitry other than circuitry embodied in a Xicor, Inc. product. No other circuits, patents, or licenses are implied.

TRADEMARK DISCLAIMER:

Xicor and the Xicor logo are registered trademarks of Xicor, Inc. AutoStore, Direct Write, Block Lock, SerialFlash, MPS, BiasLock and XDPCP are also trademarks of Xicor, Inc. All others belong to their respective owners.

U.S. PATENTS

Xicor products are covered by one or more of the following U.S. Patents: 4,326,134; 4,393,481; 4,404,475; 4,450,402; 4,486,769; 4,488,060; 4,520,461; 4,533,846; 4,599,706; 4,617,652; 4,668,932; 4,752,912; 4,829,482; 4,874,967; 4,883,976; 4,980,859; 5,012,132; 5,003,197; 5,023,694; 5,084,667; 5,153,880; 5,153,691; 5,161,137; 5,219,774; 5,270,927; 5,324,676; 5,434,396; 5,544,103; 5,587,573; 5,835,409; 5,977,585. Foreign patents and additional patents pending.

LIFE RELATED POLICY

In situations where semiconductor component failure may endanger life, system designers using this product should design the system with appropriate error detection and correction, redundancy and back-up features to prevent such an occurrence.

Xicor's products are not authorized for use in critical components in life support devices or systems.

1. Life support devices or systems are devices or systems which, (a) are intended for surgical implant into the body, or (b) support or sustain life, and whose failure to perform, when properly used in accordance with instructions for use provided in the labeling, can be reasonably expected to result in a significant injury to the user.
2. A critical component is any component of a life support device or system whose failure to perform can be reasonably expected to cause the failure of the life support device or system, or to affect its safety or effectiveness.