

**DC-DC CONVERTER APPLICATION  
HIGH VOLTAGE SWITCHING APPLICATIONS**

**Features**

- High Voltage:  $BV_{DSS}=200V(\text{Min.})$
- Low  $C_{rSS}$  :  $C_{rSS}=22pF(\text{Typ.})$
- Low gate charge :  $Qg=30nC(\text{Typ.})$
- Low  $R_{DS(on)}$  :  $R_{DS(on)}=0.17\Omega(\text{Max.})$

**Ordering Information**

Type NO.	Marking	Package Code
STK1820F	STK1820	TO-220F-3L

**Outline Dimensions**

unit : mm

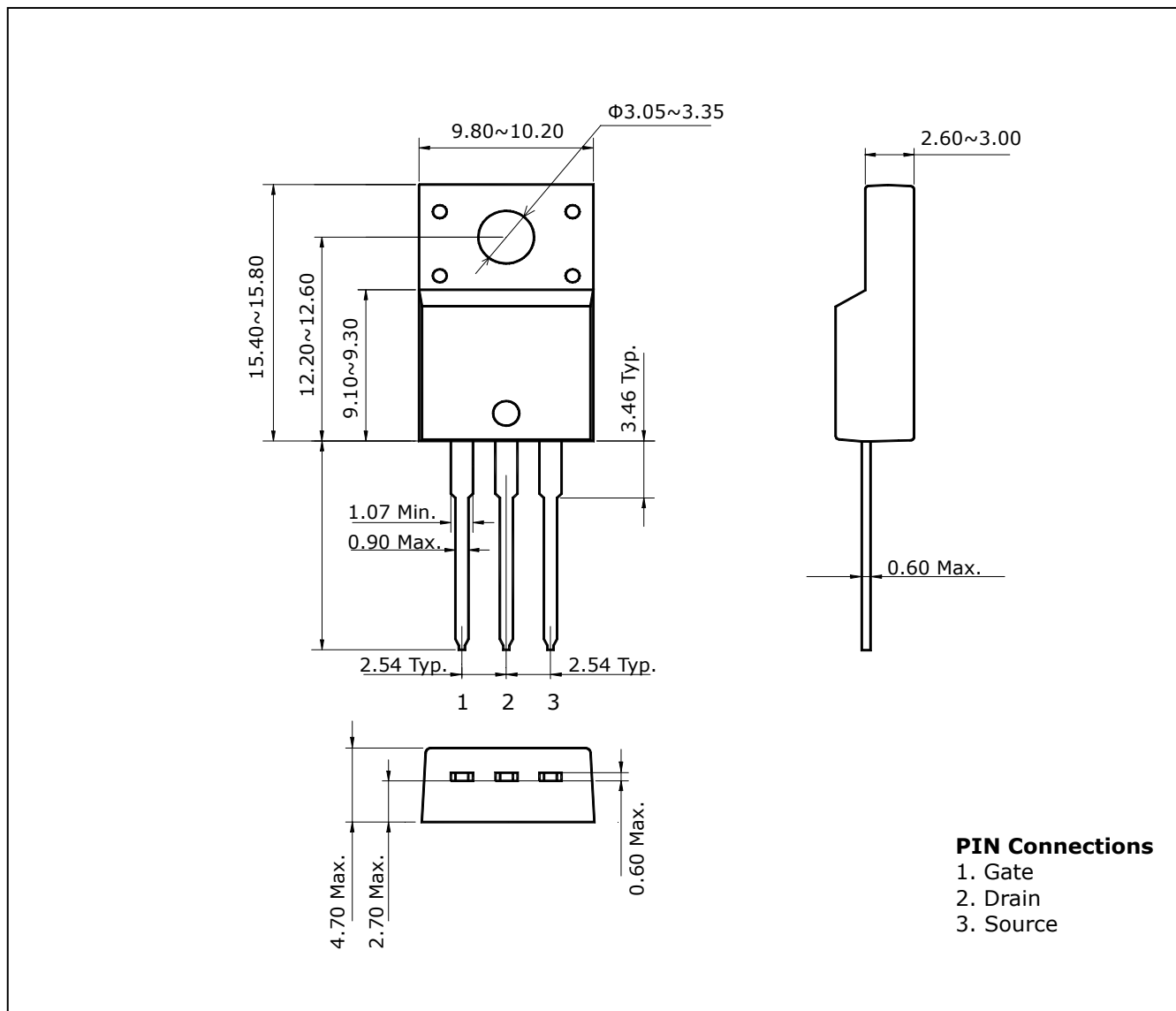

**PIN Connections**

1. Gate
2. Drain
3. Source

## Absolute maximum ratings

(Tc=25°C)

Characteristic	Symbol	Rating	Unit	
Drain-source voltage	$V_{DSS}$	200	V	
Gate-source voltage	$V_{GSS}$	±30	V	
Drain current (DC)	$I_D$	(Tc=25°C)	18	A
		(Tc=100°C)	8.6	A
Drain current (Pulsed) *	$I_{DP}$	72	A	
Drain Power dissipation	$P_D$	30	W	
Avalanche current (Single) ②	$I_{AS}$	18	A	
Single pulsed avalanche energy ②	$E_{AS}$	396	mJ	
Avalanche current (Repetitive) ①	$I_{AR}$	18	A	
Repetitive avalanche energy ①	$E_{AR}$	13.9	mJ	
Junction temperature	$T_J$	150	°C	
Storage temperature range	$T_{stg}$	-55~150		

\* Limited by maximum junction temperature

Characteristic		Symbol	Typ.	Max	Unit
Thermal resistance	Junction-case	$R_{th(J-C)}$	-	4.16	°C/W
	Junction-ambient	$R_{th(J-a)}$	-	62.5	

## Electrical Characteristics

(Tc=25°C)

Characteristic	Symbol	Test Condition	Min.	Typ.	Max.	Unit	
Drain-source breakdown voltage	$BV_{DSS}$	$I_D=250\mu A, V_{GS}=0$	200	-	-	V	
Gate-threshold voltage	$V_{GS(th)}$	$I_D=250\mu A, V_{DS}=V_{GS}$	2.0	-	4.0	V	
Drain-source leakage current	$I_{DSS}$	$V_{DS}=200V, V_{GS}=0V$	-	-	10	$\mu A$	
Gate-source leakage	$I_{GSS}$	$V_{DS}=0V, V_{GS}=\pm 30V$	-	-	$\pm 100$	nA	
Drain-Source on-resistance ④	$R_{DS(on)}$	$V_{GS}=10V, I_D=9A$	-	0.14	0.17	$\Omega$	
Forward transfer admittance ④	$g_{fs}$	$V_{DS}=40V, I_D=9A$	-	8.5	-	S	
Input capacitance	$C_{iss}$	$V_{GS}=0V, V_{DS}=25V, f=1MHz$	-	840	1260	pF	
Output capacitance	$C_{oss}$		-	150	225		
Reverse transfer capacitance	$C_{rss}$		-	22	33		
Turn-on delay time	$t_{d(on)}$	$V_{DD}=100V, I_D=18A$ $R_G=25\Omega$	-	24	36	ns	
Rise time	$t_r$		-	29	43		
Turn-off delay time	$t_{d(off)}$		③④	-	68		102
Fall time	$t_f$		-	29	43		
Total gate charge	$Q_g$	$V_{DD}=100V, V_{GS}=10V$ $I_D=18A$	-	30	45	nC	
Gate-source charge	$Q_{gs}$		-	4.8	7.2		
Gate-drain charge	$Q_{gd}$		③④	-	11.5		17.3

## Source-Drain Diode Ratings and Characteristics

(Tc=25°C)

Characteristic	Symbol	Test Condition	Min	Typ	Max	Unit
Continuous source current	$I_S$	Integral reverse diode in the MOSFET	-	-	18	A
Source current (Pulsed) ①	$I_{SP}$		-	-	72	
Forward voltage ④	$V_{SD}$	$V_{GS}=0V, I_S=18A$	-	-	1.4	V
Reverse recovery time	$t_{rr}$	$I_S=18A, V_{GS}=0V$ $di_s/dt=100A/us$	-	253	-	ns
Reverse recovery charge	$Q_{rr}$		-	2.63	-	$\mu C$

Note ;

- ① Repetitive Rating : Pulse Width Limited by Maximum Junction Temperature  $\mu$
- ②  $L=2.0mH, I_{AS}=18A, V_{DD}=50V, R_G=25\Omega$
- ③ Pulse Test : Pulse Width < 300us, Duty cycle  $\leq$  2%
- ④ Essentially independent of operating temperature

## Electrical Characteristic Curves

**Fig. 1  $I_D - V_{DS}$**

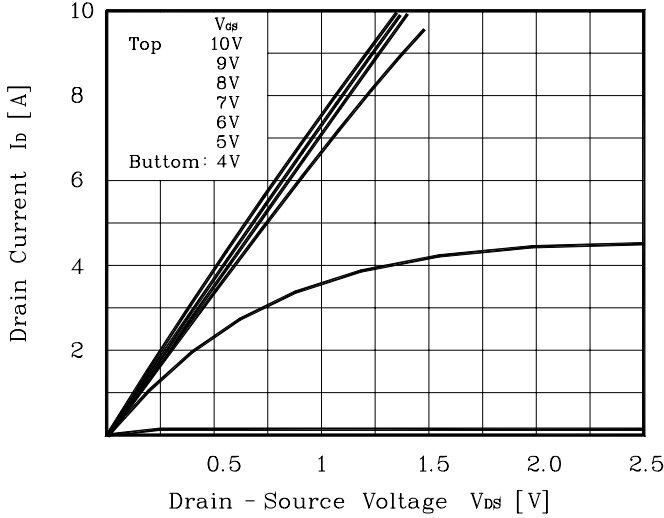

**Fig. 2  $I_D - V_{GS}$**

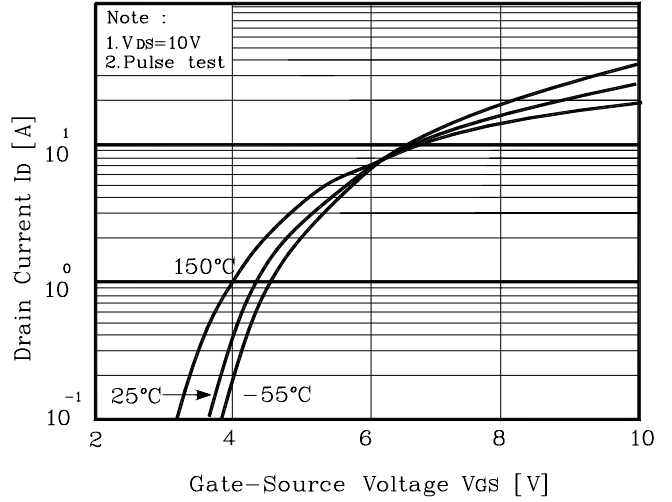

**Fig. 3  $R_{DS(on)} - I_D$**

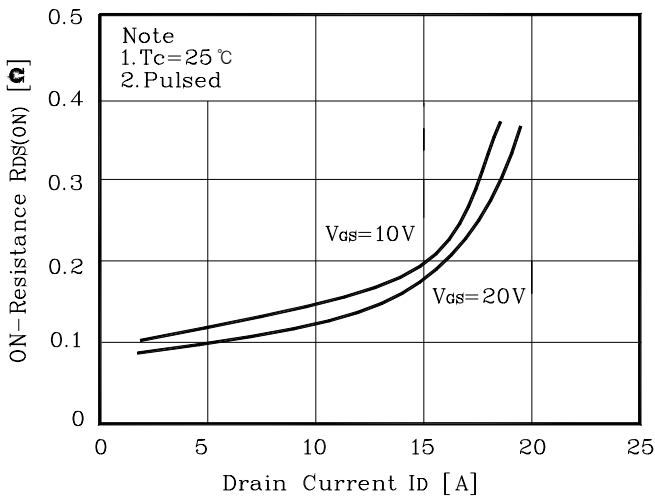

**Fig. 4  $I_S - V_{SD}$**

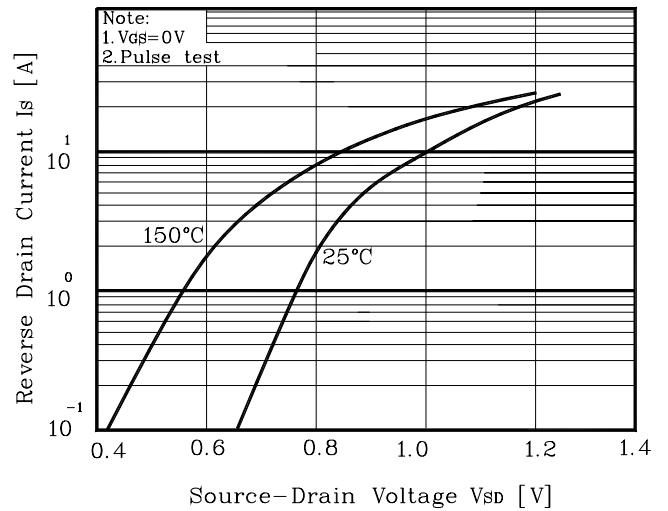

**Fig. 5 Capacitance -  $V_{DS}$**

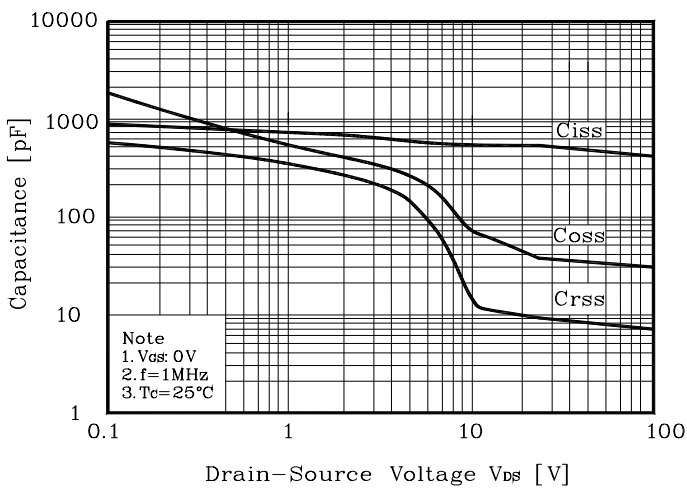

**Fig. 6  $V_{GS} - Q_G$**

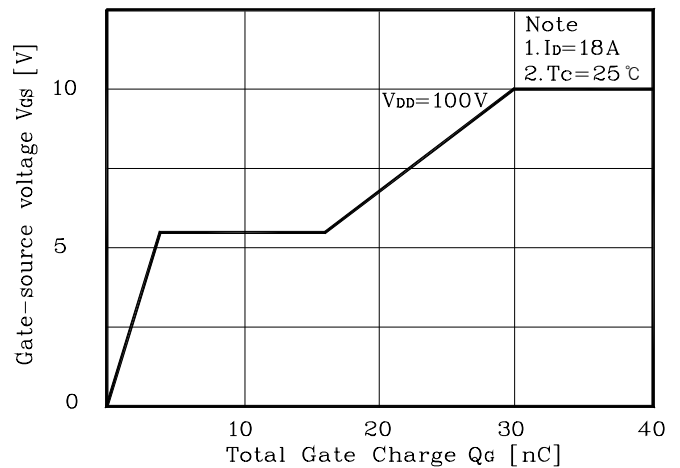

**Fig. 7  $V_{DSS} - T_J$**

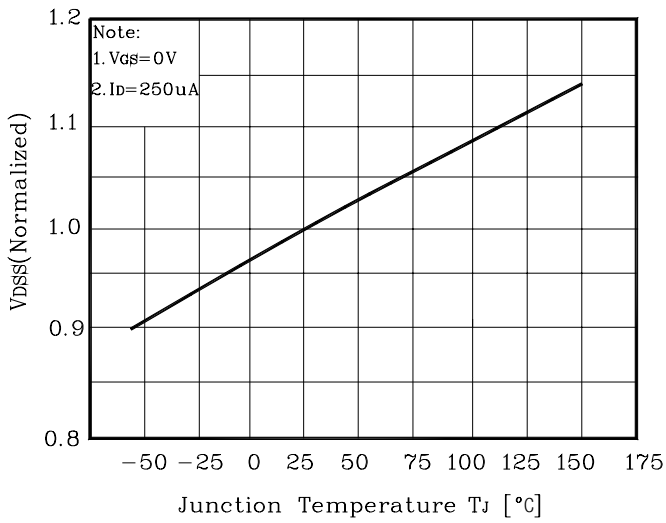

**Fig. 8  $R_{DS(on)} - T_J$**

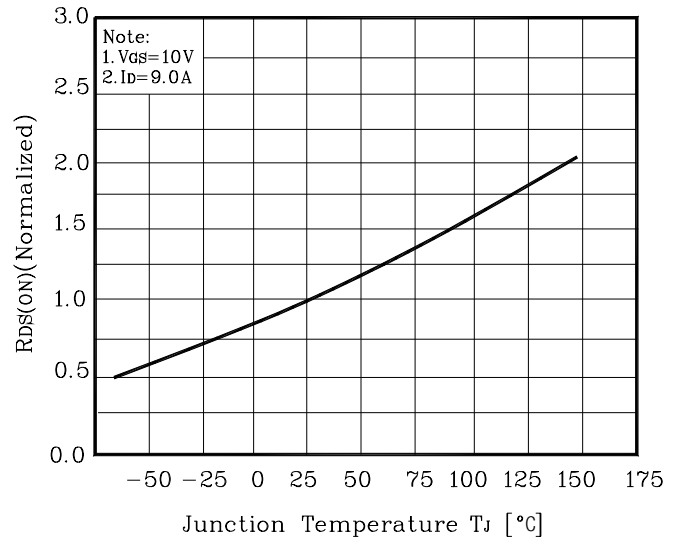

**Fig. 9  $I_D - T_C$**

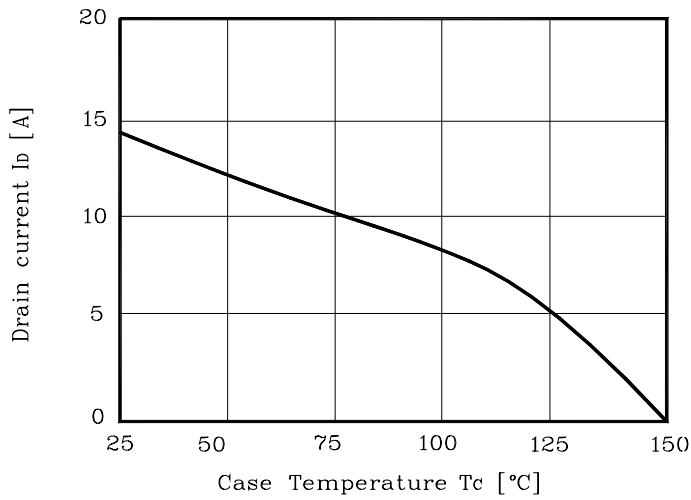

**Fig. 10 Safe Operating Area**

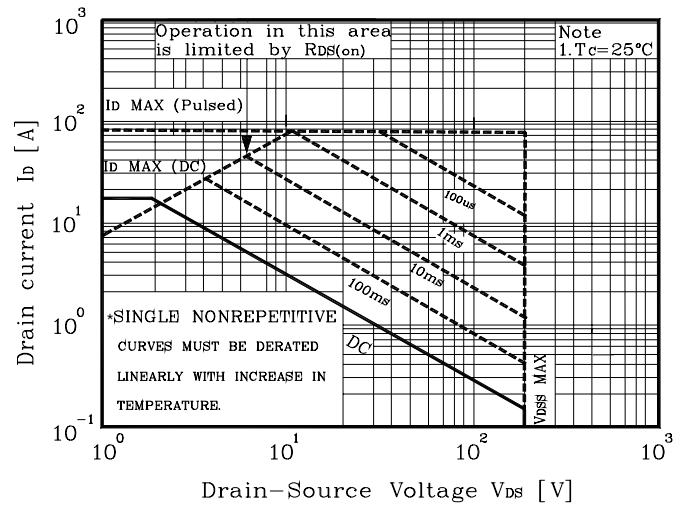

**Fig. 11 Gate Charge Test Circuit & Waveform**

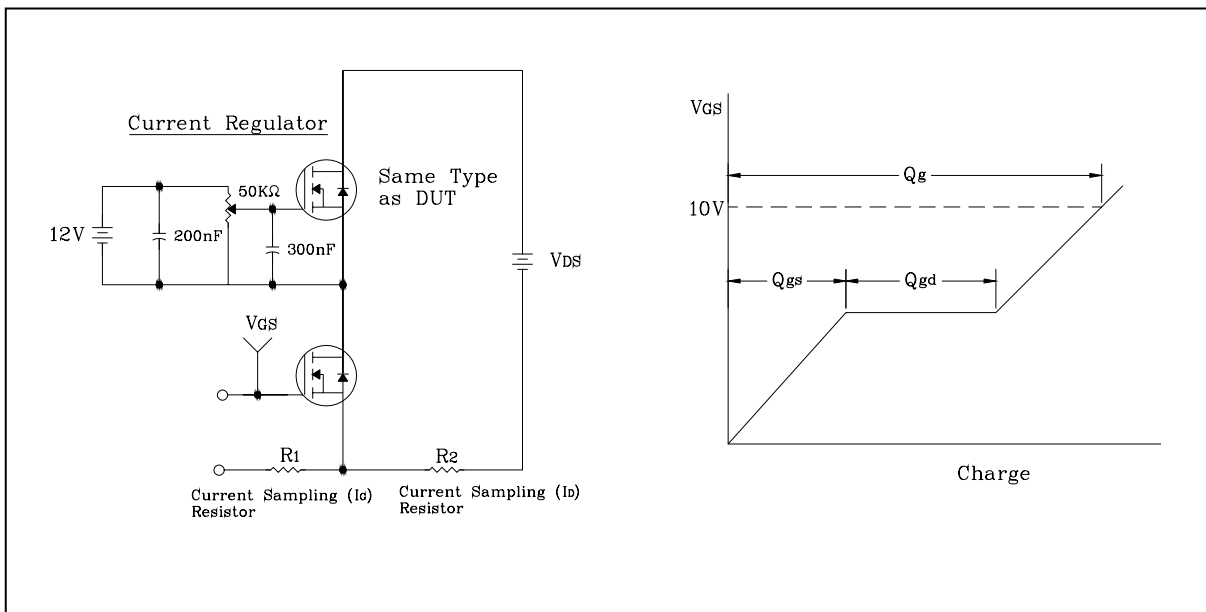

**Fig. 12 Resistive Switching Test Circuit & Waveform**

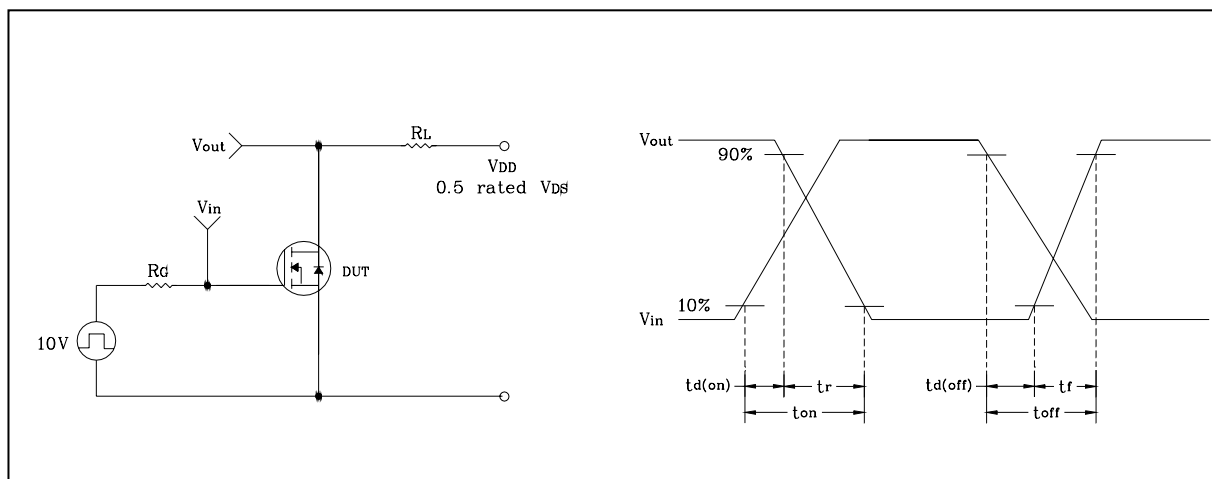

**Fig. 13 E<sub>AS</sub> Test Circuit & Waveform**

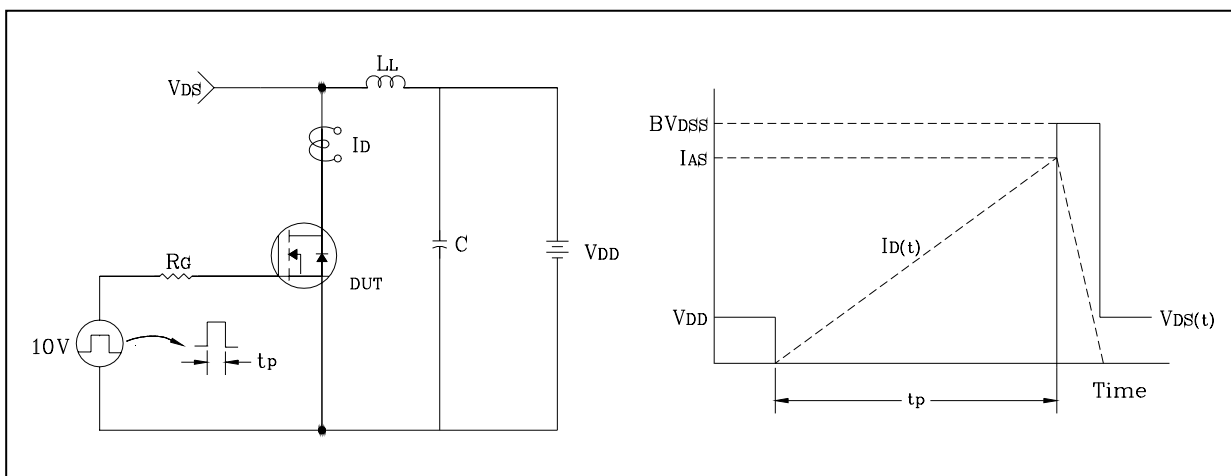
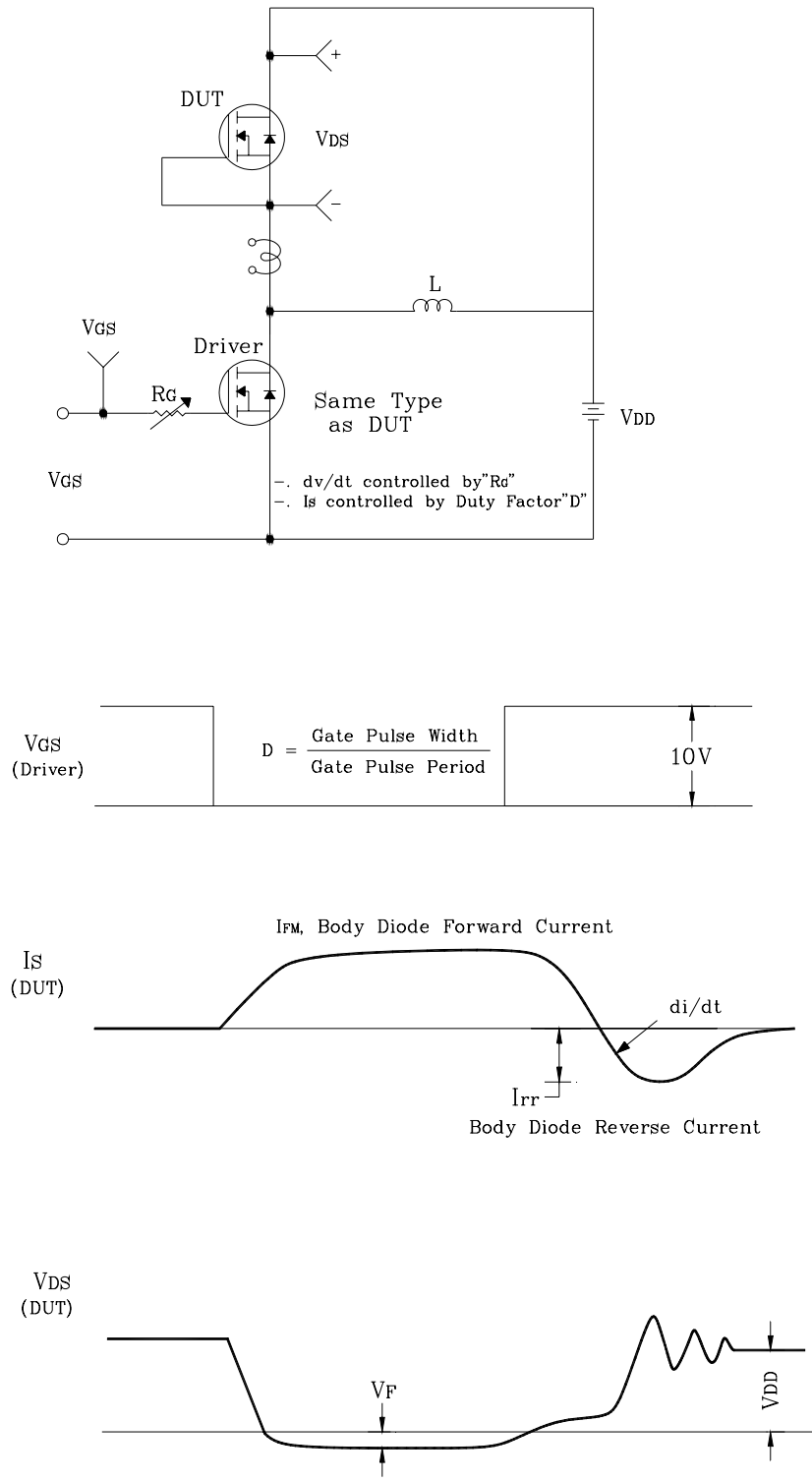

Fig. 14 Diode Reverse Recovery Time Test Circuit & Waveform



**The AUK Corp. products are intended for the use as components in general electronic equipment (Office and communication equipment, measuring equipment, home appliance, etc.).**

**Please make sure that you consult with us before you use these AUK Corp. products in equipments which require high quality and / or reliability, and in equipments which could have major impact to the welfare of human life(atomic energy control, airplane, spaceship, transportation, combustion control, all types of safety device, etc.). AUK Corp. cannot accept liability to any damage which may occur in case these AUK Corp. products were used in the mentioned equipments without prior consultation with AUK Corp..**

**Specifications mentioned in this publication are subject to change without notice.**