

3-Terminal Fixed Negative Voltage Regulators

Pin Arrangement

TO-220

1. Ground
 2. Input
 3. Output
- (heatsink connected to pin 2)

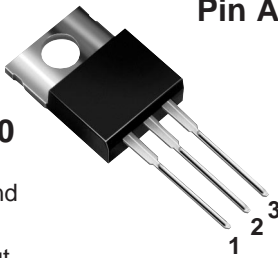

Description

These voltage regulators are intended as complements to the popular MC78xx Series devices. These negative regulators are available in the same seven-voltage options as the MC78xx devices. In addition, one extra voltage option commonly employed in MECL systems is also available in the negative MC79xx Series.

Available in fixed output voltage options from -5.0 to -24 volts, these regulators employ current limiting, thermal shut-down, and safe-area compensation – making them remarkably rugged under most operating conditions. With adequate heatsinking they can deliver output currents in excess of 1.5 ampere.

Standard Application

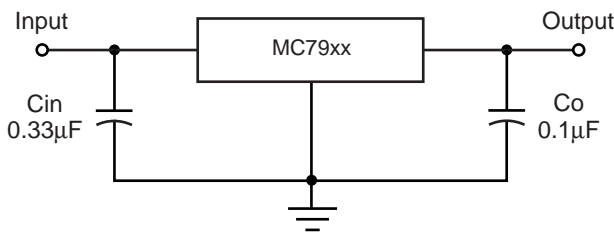

Notes:

A common ground is required between the input and the output voltages. The input voltage must remain typically 2.0V more negative even during the high point on the input ripple voltage.

xx = these two digits of the part number indicate output voltage.

Cin is required if regulator is located an appreciable distance from power supply filter.

Co improves stability and transient response.

Features

- Output current in excess of 1.5 Ampere
- No external components required
- Internal thermal overload protection
- Internal short-circuit current limiting
- Output transistor safe-area compensation
- Output voltage offered in 2% tolerance

Mechanical Data

Case: TO-220 Package

Weight: approx. 2.24g

Case outline is on the back page

Internal Block Diagram

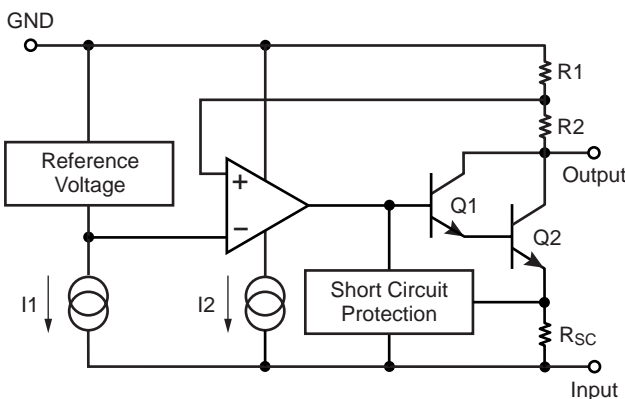

Maximum Ratings Ratings at 25°C ambient temperature unless otherwise specified.

Parameter	Symbol	Value	Unit
Input Voltage ⁽¹⁾	V _{in}	-30	V
Input Voltage ⁽²⁾	V _{in}	-40	V
Power Dissipation ⁽³⁾	P _D	15	W
Operating Junction Temperature Range	T _J	-20 to +150	°C
Storage Junction Temperature Range	T _{stg}	-65 to +150	°C

Notes: (1) MC7905 to MC7918

(2) MC7924

(3) Follow the derating curve. When T_J exceeds 150°C, the internal circuit cuts off the output

Electrical Characteristics – MC7905

V_{in} = -10V, I_{out} = 500mA, C_{in} = 2μF, C_{out} = 1μF; T_J = 0°C to 125°C, unless otherwise noted.

Parameter	Symbol	Test Circuit	Conditions	Min.	Typ.	Max.	Unit
Output Voltage	V _o	1	T _J = 25°C	-4.90	-5.0	-5.10	V
			V _{in} = -7 to -20V, I _o = 5mA to 1A	-4.85	—	-5.15	
Line Regulation (T _J = 25°C)	ΔREG _{line}	1	V _{in} = -7 to -25V	—	3	100	mV
			V _{in} = -8 to -12V	—	1	50	
Load Regulation (T _J = 25°C)	ΔREG _{load}	1	I _o = 5mA to 1.5A	—	10	100	mV
			I _o = 250mA to 750mA	—	3	50	
Quiescent Current	I _q	2	T _J = 25°C	—	2	4	mA
Quiescent Current Change (T _J = 25°C)	ΔI _q	2	V _{in} = -7 to -25V	—	—	1.3	mA
			I _o = 5mA to 1A	—	—	0.5	
Output Noise Voltage (T _J = 25°C)	V _n	1	f = 10Hz to 100KHz	—	40	—	μV
Ripple Rejection Ratio	RR	3	V _{in} = -8 to -18V I _o = 100mA, f = 120Hz	62	74	—	dB
Dropout Voltage	V _{drop}		I _o = 1.0A, T _J = 25°C	—	1.1	—	V
Peak Output Current	I _{o-peak}	1	T _J = 25°C	—	2.1	—	A
Temp. Coefficient of Output Voltage	ΔV _o /ΔT _A	1	I _o = 5mA, T _J = 0 to 125°C	—	-0.4	—	mV/°C

Note: Where the condition T_J = 25°C is specified, pulse testing (<10ms) with low duty cycle is required to maintain junction temperature stability.



Electrical Characteristics – MC7906

$V_{in} = -11V$, $I_{out} = 500mA$, $C_{in} = 2\mu F$, $C_{out} = 1\mu F$; $T_J = 0^{\circ}C$ to $125^{\circ}C$, unless otherwise noted.

Parameter	Symbol	Test Circuit	Conditions	Min.	Typ.	Max.	Unit
Output Voltage	V_o	1	$T_J = 25^{\circ}C$	-5.88	-6.0	-6.12	V
			$V_{in} = -8$ to $-21V$, $I_o = 5mA$ to $1A$	-5.82	—	-6.18	
Line Regulation ($T_J = 25^{\circ}C$)	REG _{line}	1	$V_{in} = -8$ to $-25V$	—	4	120	mV
			$V_{in} = -9$ to $-13V$	—	1.5	60	
Load Regulation ($T_J = 25^{\circ}C$)	REG _{load}	1	$I_o = 5mA$ to $1.5A$	—	10	120	mV
			$I_o = 250mA$ to $750mA$	—	3	60	
Quiescent Current	I_q	2	$T_J = 25^{\circ}C$	—	2	4	mA
Quiescent Current Change ($T_J = 25^{\circ}C$)	ΔI_q	2	$V_{in} = -8$ to $-25V$	—	—	1.3	mA
			$I_o = 5mA$ to $1A$	—	—	0.5	
Output Noise Voltage ($T_J = 25^{\circ}C$)	V_n	1	$f = 10Hz$ to $100KHz$	—	44	—	μV
Ripple Rejection Ratio	RR	3	$V_{in} = -9$ to $-19V$ $I_o = 100mA$, $f = 120Hz$	60	73	—	dB
Dropout Voltage	V_{drop}		$I_o = 1.0A$, $T_J = 25^{\circ}C$	—	1.1	—	V
Peak Output Current	I_{o-peak}	1	$T_J = 25^{\circ}C$	—	2.1	—	A
Temp. Coefficient of Output Voltage	$\Delta V_o/\Delta T_A$	1	$I_o = 5mA$, $T_J = 0$ to $125^{\circ}C$	—	-0.5	—	mV/ $^{\circ}C$

Electrical Characteristics – MC7908

$V_{in} = -14V$, $I_{out} = 500mA$, $C_{in} = 2\mu F$, $C_{out} = 1\mu F$; $T_J = 0^{\circ}C$ to $125^{\circ}C$, unless otherwise noted.

Parameter	Symbol	Test Circuit	Conditions	Min.	Typ.	Max.	Unit
Output Voltage	V_o	1	$T_J = 25^{\circ}C$	-7.84	-8.0	-8.16	V
			$V_{in} = -10.5$ to $-23V$, $I_o = 5mA$ to $1A$	-7.76	—	-8.24	
Line Regulation ($T_J = 25^{\circ}C$)	REG _{line}	1	$V_{in} = -10.5$ to $-25V$	—	6	160	mV
			$V_{in} = -11$ to $-15V$	—	2	80	
Load Regulation ($T_J = 25^{\circ}C$)	REG _{load}	1	$I_o = 5mA$ to $1.5A$	—	12	160	mV
			$I_o = 250mA$ to $750mA$	—	4	80	
Quiescent Current	I_q	2	$T_J = 25^{\circ}C$	—	2.2	4.5	mA
Quiescent Current Change ($T_J = 25^{\circ}C$)	ΔI_q	2	$V_{in} = -10.5$ to $-25V$	—	—	1	mA
			$I_o = 5mA$ to $1A$	—	—	0.5	
Output Noise Voltage ($T_J = 25^{\circ}C$)	V_n	1	$f = 10Hz$ to $100KHz$	—	52	—	μV
Ripple Rejection Ratio	RR	3	$V_{in} = -11$ to $-21V$ $I_o = 100mA$, $f = 120Hz$	56	71	—	dB
Dropout Voltage	V_{drop}		$I_o = 1.0A$, $T_J = 25^{\circ}C$	—	1.1	—	V
Peak Output Current	I_{o-peak}	1	$T_J = 25^{\circ}C$	—	2.1	—	A
Temp. Coefficient of Output Voltage	$\Delta V_o/\Delta T_A$	1	$I_o = 5mA$, $T_J = 0$ to $125^{\circ}C$	—	-0.6	—	mV/ $^{\circ}C$

MC79xxCT Series



Vishay

formerly General Semiconductor

Electrical Characteristics – MC7909

$V_{in} = -15V$, $I_{out} = 500mA$, $C_{in} = 2\mu F$, $C_{out} = 1\mu F$; $T_J = 0^{\circ}C$ to $125^{\circ}C$, unless otherwise noted.

Parameter	Symbol	Test Circuit	Conditions	Min.	Typ.	Max.	Unit
Output Voltage	V_o	1	$T_J = 25^{\circ}C$	-8.82	-9.0	-9.18	V
			$V_{in} = -11.5$ to $-24V$, $I_o = 5mA$ to $1A$	-8.73	—	-9.27	
Line Regulation ($T_J = 25^{\circ}C$)	REG _{line}	1	$V_{in} = -11.5$ to $-27V$	—	7	180	mV
			$V_{in} = -12$ to $-16V$	—	2	90	
Load Regulation ($T_J = 25^{\circ}C$)	REG _{load}	1	$I_o = 5mA$ to $1.5A$	—	12	180	mV
			$I_o = 250mA$ to $750mA$	—	4	90	
Quiescent Current	I_q	2	$T_J = 25^{\circ}C$	—	2.2	4.5	mA
Quiescent Current Change ($T_J = 25^{\circ}C$)	ΔI_q	2	$V_{in} = -11.5$ to $-27V$	—	—	1	mA
			$I_o = 5mA$ to $1A$	—	—	0.5	
Output Noise Voltage ($T_J = 25^{\circ}C$)	V_n	1	$f = 10Hz$ to $100KHz$	—	58	—	μV
Ripple Rejection Ratio	RR	3	$V_{in} = -12$ to $-22V$ $I_o = 100mA$, $f = 120Hz$	56	71	—	dB
Dropout Voltage	V_{drop}		$I_o = 1.0A$, $T_J = 25^{\circ}C$	—	1.1	—	V
Peak Output Current	I_{o-peak}	1	$T_J = 25^{\circ}C$	—	2.1	—	A
Temp. Coefficient of Output Voltage	$\Delta V_o/\Delta T_A$	1	$I_o = 5mA$, $T_J = 0$ to $125^{\circ}C$	—	0.6	—	mV/ $^{\circ}C$

Electrical Characteristics – MC7912

$V_{in} = -19V$, $I_{out} = 500mA$, $C_{in} = 2\mu F$, $C_{out} = 1\mu F$; $T_J = 0^{\circ}C$ to $125^{\circ}C$, unless otherwise noted.

Parameter	Symbol	Test Circuit	Conditions	Min.	Typ.	Max.	Unit
Output Voltage	V_o	1	$T_J = 25^{\circ}C$	-11.76	-12.0	-12.24	V
			$V_{in} = -14.5$ to $-27V$, $I_o = 5mA$ to $1A$	-11.64	—	-12.36	
Line Regulation ($T_J = 25^{\circ}C$)	REG _{line}	1	$V_{in} = -14.5$ to $-30V$	—	10	240	mV
			$V_{in} = -15$ to $-19V$	—	3	120	
Load Regulation ($T_J = 25^{\circ}C$)	REG _{load}	1	$I_o = 5mA$ to $1.5A$	—	12	240	mV
			$I_o = 250mA$ to $750mA$	—	4	120	
Quiescent Current	I_q	2	$T_J = 25^{\circ}C$	—	2.5	5	mA
Quiescent Current Change ($T_J = 25^{\circ}C$)	ΔI_q	2	$V_{in} = -14.5$ to $-30V$	—	—	1	mA
			$I_o = 5mA$ to $1A$	—	—	0.5	
Output Noise Voltage ($T_J = 25^{\circ}C$)	V_n	1	$f = 10Hz$ to $100KHz$	—	75	—	μV
Ripple Rejection Ratio	RR	3	$V_{in} = -15$ to $-25V$ $I_o = 100mA$, $f = 120Hz$	55	70	—	dB
Dropout Voltage	V_{drop}		$I_o = 1.0A$, $T_J = 25^{\circ}C$	—	1.1	—	V
Peak Output Current	I_{o-peak}	1	$T_J = 25^{\circ}C$	—	2.1	—	A
Temp. Coefficient of Output Voltage	$\Delta V_o/\Delta T_A$	1	$I_o = 5mA$, $T_J = 0$ to $125^{\circ}C$	—	-0.8	—	mV/ $^{\circ}C$



Electrical Characteristics – MC7915

$V_{in} = -23V$, $I_{out} = 500mA$, $C_{in} = 2\mu F$, $C_{out} = 1\mu F$; $T_J = 0^{\circ}C$ to $125^{\circ}C$, unless otherwise noted.

Parameter	Symbol	Test Circuit	Conditions	Min.	Typ.	Max.	Unit
Output Voltage	V_o	1	$T_J = 25^{\circ}C$	-14.7	-15	-15.3	V
			$V_{in} = -17.5$ to $-30V$, $I_o = 5mA$ to $1A$	-14.55	—	-15.45	
Line Regulation ($T_J = 25^{\circ}C$)	REG _{line}	1	$V_{in} = -17.5$ to $-30V$	—	11	300	mV
			$V_{in} = -18$ to $-22V$	—	3	150	
Load Regulation ($T_J = 25^{\circ}C$)	REG _{load}	1	$I_o = 5mA$ to $1.5A$	—	12	300	mV
			$I_o = 250mA$ to $750mA$	—	4	150	
Quiescent Current	I_q	2	$T_J = 25^{\circ}C$	—	2.5	5	mA
Quiescent Current Change ($T_J = 25^{\circ}C$)	ΔI_q	2	$V_{in} = -17.5$ to $-30V$	—	—	1	mA
			$I_o = 5mA$ to $1A$	—	—	0.5	
Output Noise Voltage ($T_J = 25^{\circ}C$)	V_n	1	$f = 10Hz$ to $100KHz$	—	90	—	μV
Ripple Rejection Ratio	RR	3	$V_{in} = -18$ to $-28V$ $I_o = 100mA$, $f = 120Hz$	54	69	—	dB
Dropout Voltage	V_{drop}		$I_o = 1.0A$, $T_J = 25^{\circ}C$	—	1.1	—	V
Peak Output Current	I_{o-peak}	1	$T_J = 25^{\circ}C$	—	2.1	—	A
Temp. Coefficient of Output Voltage	$\Delta V_o/\Delta T_A$	1	$I_o = 5mA$, $T_J = 0$ to $125^{\circ}C$	—	0.9	—	mV/ $^{\circ}C$

Electrical Characteristics – MC7918

$V_{in} = -27V$, $I_{out} = 500mA$, $C_{in} = 2\mu F$, $C_{out} = 1\mu F$; $T_J = 0^{\circ}C$ to $125^{\circ}C$, unless otherwise noted.

Parameter	Symbol	Test Circuit	Conditions	Min.	Typ.	Max.	Unit
Output Voltage	V_o	1	$T_J = 25^{\circ}C$	-17.64	-18.0	-18.36	V
			$V_{in} = -21$ to $-33V$, $I_o = 5mA$ to $1A$	-17.46	—	-18.54	
Line Regulation ($T_J = 25^{\circ}C$)	REG _{line}	1	$V_{in} = -21$ to $-33V$	—	15	360	mV
			$V_{in} = -22$ to $-26V$	—	5	180	
Load Regulation ($T_J = 25^{\circ}C$)	REG _{load}	1	$I_o = 5mA$ to $1.5A$	—	12	360	mV
			$I_o = 250mA$ to $750mA$	—	4	180	
Quiescent Current	I_q	2	$T_J = 25^{\circ}C$	—	2.5	5	mA
Quiescent Current Change ($T_J = 25^{\circ}C$)	ΔI_q	2	$V_{in} = -21$ to $-33V$	—	—	1	mA
			$I_o = 5mA$ to $1A$	—	—	0.5	
Output Noise Voltage ($T_J = 25^{\circ}C$)	V_n	1	$f = 10Hz$ to $100KHz$	—	110	—	μV
Ripple Rejection Ratio	RR	3	$V_{in} = -21$ to $-31V$ $I_o = 100mA$, $f = 120Hz$	53	68	—	dB
Dropout Voltage	V_{drop}		$I_o = 1.0A$, $T_J = 25^{\circ}C$	—	1.1	—	V
Peak Output Current	I_{o-peak}	1	$T_J = 25^{\circ}C$	—	2.1	—	A
Temp. Coefficient of Output Voltage	$\Delta V_o/\Delta T_A$	1	$I_o = 5mA$, $T_J = 0$ to $125^{\circ}C$	—	-1	—	mV/ $^{\circ}C$

Vishay
formerly General Semiconductor

Electrical Characteristics – MC7924

$V_{in} = -33V$, $I_{out} = 500mA$, $C_{in} = 2\mu F$, $C_{out} = 1\mu F$; $T_J = 0^\circ C$ to $125^\circ C$, unless otherwise noted.

Parameter	Symbol	Test Circuit	Conditions	Min.	Typ.	Max.	Unit
Output Voltage	V_o	1	$T_J = 25^\circ C$	-23.52	-24	-24.48	V
			$V_{in} = -26$ to $-38V$, $I_o = 5mA$ to $1A$	-23.28	—	-24.72	
Line Regulation ($T_J = 25^\circ C$)	REG _{line}	1	$V_{in} = -26$ to $-38V$	—	18	480	mV
			$V_{in} = -27$ to $-32V$	—	6	240	
Load Regulation ($T_J = 25^\circ C$)	REG _{load}	1	$I_o = 5mA$ to $1.5A$	—	12	480	mV
			$I_o = 250mA$ to $750mA$	—	4	240	
Quiescent Current	I_q	2	$T_J = 25^\circ C$	—	3	5	mA
Quiescent Current Change ($T_J = 25^\circ C$)	ΔI_q	2	$V_{in} = -26$ to $-38V$	—	—	1	mA
			$I_o = 5mA$ to $1A$	—	—	0.5	
Output Noise Voltage ($T_J = 25^\circ C$)	V_n	1	$f = 10Hz$ to $100KHz$	—	170	—	μV
Ripple Rejection Ratio	RR	3	$V_{in} = -26$ to $-36V$ $I_o = 100mA$, $f = 120Hz$	50	65	—	dB
Dropout Voltage	V_{drop}		$I_o = 1.0A$, $T_J = 25^\circ C$	—	1.1	—	V
Peak Output Current	I_{o-peak}	1	$T_J = 25^\circ C$	—	2.1	—	A
Temp. Coefficient of Output Voltage	$\Delta V_o/\Delta T_A$	1	$I_o = 5mA$, $T_J = 0$ to $125^\circ C$	—	-1	—	$mV/^\circ C$

Test Circuit 1

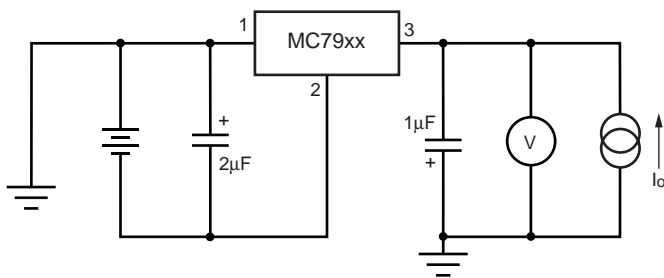

Test Circuit 2

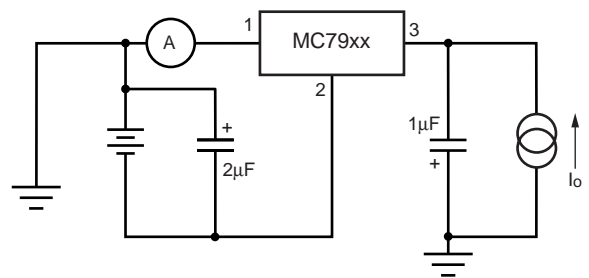

Test Circuit 3

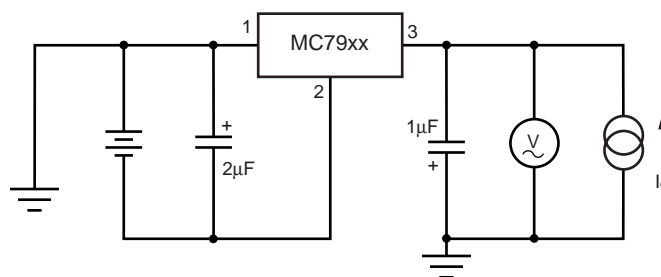

Ratings and Characteristic Curves ($T_A = 25^\circ\text{C}$ unless otherwise noted)

Fig. 1 – Power Dissipation vs. Ambient Temperature

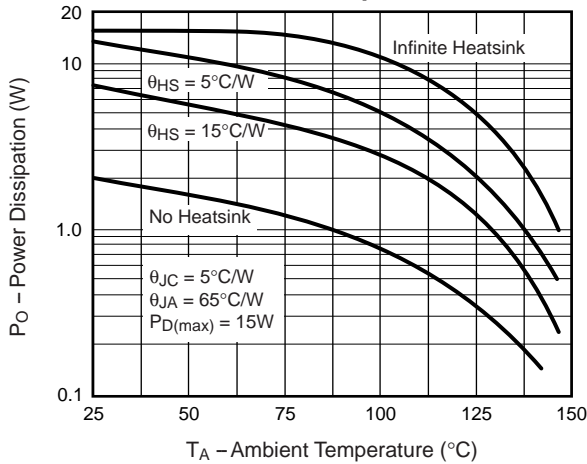

Fig. 2 – Quiescent Current

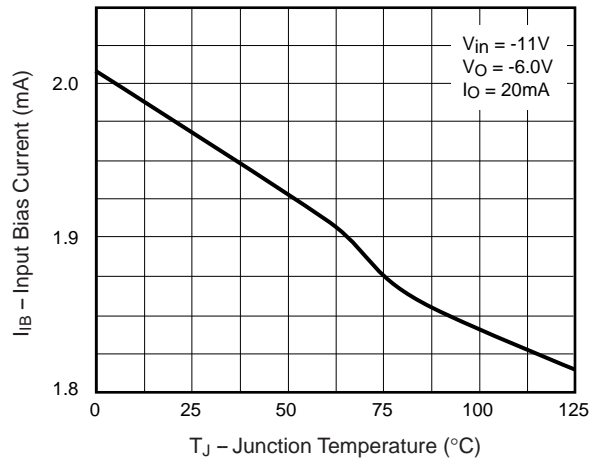

Fig. 3 – Peak Output Current

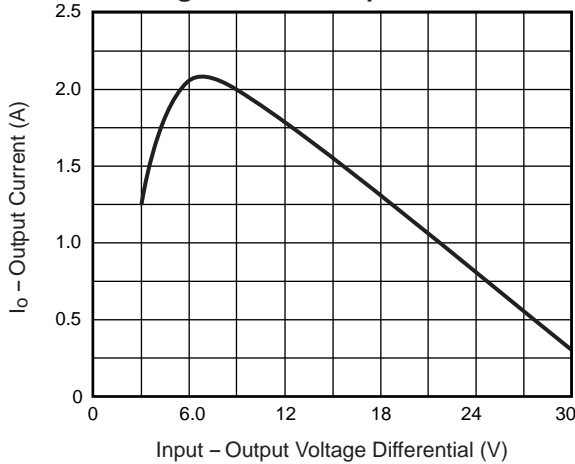

Fig. 4 – Ripple Rejection Ratio vs. Frequency

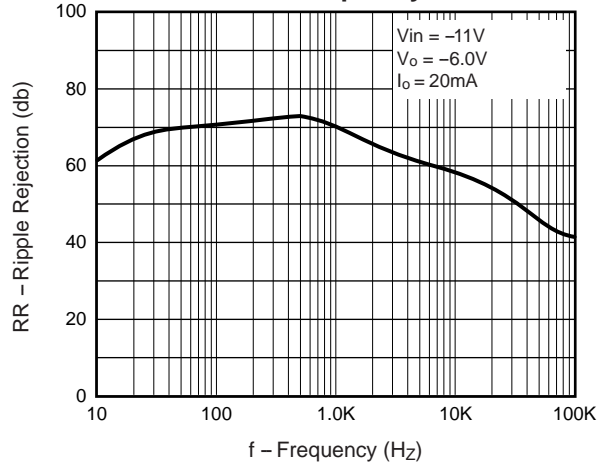

Fig. 5 – Ripple Rejection vs. Output Voltage

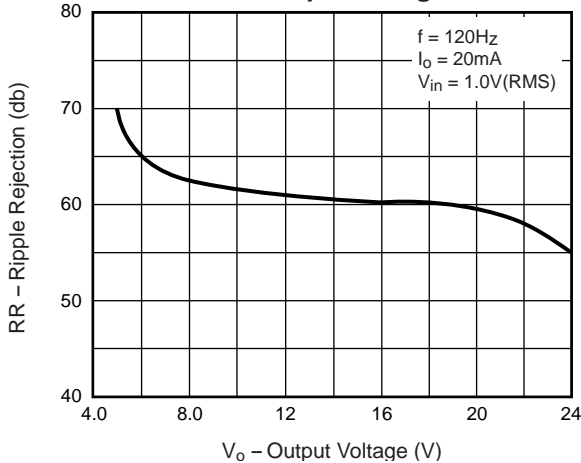
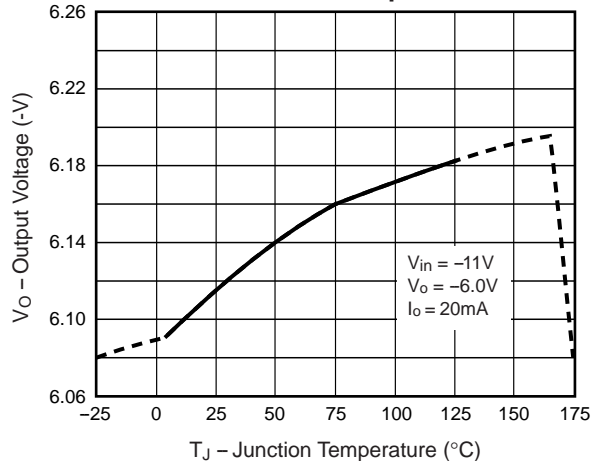

Fig. 6 – Output Voltage vs. Junction Temperature



TO-220 Case Outline

