

Rectifier diodes ultrafast

BYV29X-600

FEATURES

- Low forward volt drop
- Fast switching
- Soft recovery characteristic
- High thermal cycling performance
- Low thermal resistance

SYMBOL

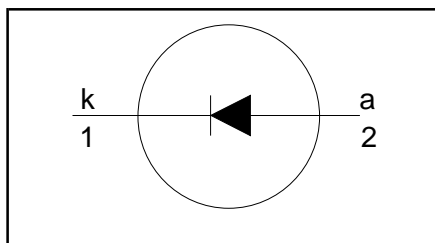

QUICK REFERENCE DATA

$V_R = 600V$
$V_F \leq 1.03 V$
$I_{F(\text{peak})} = 7 A$
$t_{tr} \leq 60 ns$

GENERAL DESCRIPTION

Ultra-fast, epitaxial rectifier diodes intended for use as output rectifiers in high frequency switched mode power supplies.

The BYV29X-600 is supplied in the conventional leaded SOD113 (SOT186a) package.

PINNING

PIN	DESCRIPTION
1	cathode
2	anode
tab	isolated

SOD113 (SOT186a)

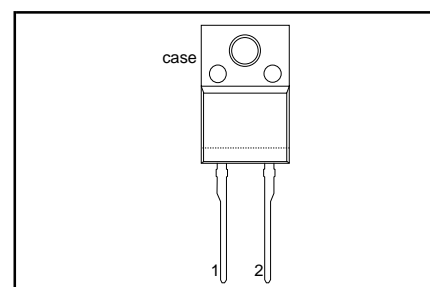

LIMITING VALUES

Limiting values in accordance with the Absolute Maximum System (IEC 134).

SYMBOL	PARAMETER	CONDITIONS	MIN.	MAX.	UNIT
V_{RRM}	Peak repetitive reverse voltage		-	600	V
V_{RWM}	Crest working reverse voltage		-	600	V
V_R	Continuous reverse voltage		-	600	V
$I_{F(AV)}$	Average forward current ¹	square wave; $\delta = 0.5$; $T_{mb} \leq 100^\circ C$	-	9	A
I_{FRM}	Repetitive peak forward current	$t = 25 \mu s$; $\delta = 0.5$; $T_{mb} \leq 100^\circ C$	-	18	A
I_{FSM}	Non-repetitive peak forward current.	$t = 10 ms$ $t = 8.3 ms$ sinusoidal; with reapplied $V_{RRM(\text{max})}$	-	70 77	A A
T_{stg}	Storage temperature		-40	150	$^\circ C$
T_j	Operating junction temperature		-	150	$^\circ C$

THERMAL RESISTANCES

SYMBOL	PARAMETER	CONDITIONS	MIN.	TYP.	MAX.	UNIT
$R_{th j-hs}$	Thermal resistance junction to heat sink		-	-	5.5	K/W
$R_{th j-a}$	Thermal resistance junction to ambient	in free air.	-	60	-	K/W

¹ Neglecting switching and reverse current losses.

Rectifier diodes ultrafast

BYV29X-600

ISOLATION LIMITING VALUE & CHARACTERISTIC

$T_{hs} = 25\text{ °C}$ unless otherwise specified

SYMBOL	PARAMETER	CONDITIONS	MIN.	TYP.	MAX.	UNIT
V_{isol}	R.M.S. isolation voltage from both terminals to external heatsink	$f = 50\text{-}60\text{ Hz}$; sinusoidal waveform; R.H. $\leq 65\%$; clean and dustfree	-		2500	V
C_{isol}	Capacitance from both terminals to external heatsink	$f = 1\text{ MHz}$	-	10	-	pF

ELECTRICAL CHARACTERISTICS

$T_j = 25\text{ °C}$ unless otherwise stated

SYMBOL	PARAMETER	CONDITIONS	MIN.	TYP.	MAX.	UNIT
V_F	Forward voltage	$I_F = 8\text{ A}$; $T_j = 150\text{ °C}$	-	0.90	1.03	V
		$I_F = 8\text{ A}$	-	1.05	1.25	V
		$I_F = 20\text{ A}$	-	1.30	1.45	V
I_R	Reverse current	$V_R = V_{RRM}$	-	2.0	50	μA
		$V_R = V_{RRM}$; $T_j = 100\text{ °C}$	-	0.1	0.35	mA
Q_s	Reverse recovery charge	$I_F = 2\text{ A}$ to $V_R \geq 30\text{ V}$; $di_F/dt = 20\text{ A}/\mu\text{s}$	-	40	70	nC
t_{rr}	Reverse recovery time	$I_F = 1\text{ A}$ to $V_R \geq 30\text{ V}$; $di_F/dt = 100\text{ A}/\mu\text{s}$	-	50	60	ns
I_{rrm}	Peak reverse recovery current	$I_F = 10\text{ A}$ to $V_R \geq 30\text{ V}$; $di_F/dt = 50\text{ A}/\mu\text{s}$; $T_j = 100\text{ °C}$	-	3.0	5.5	A
V_{fr}	Forward recovery voltage	$I_F = 10\text{ A}$; $di_F/dt = 10\text{ A}/\mu\text{s}$	-	3.2	-	V

Rectifier diodes
ultrafast

BYV29X-600

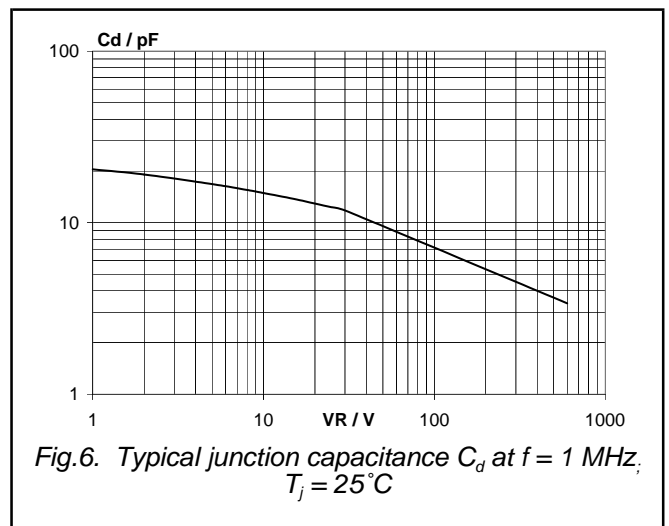
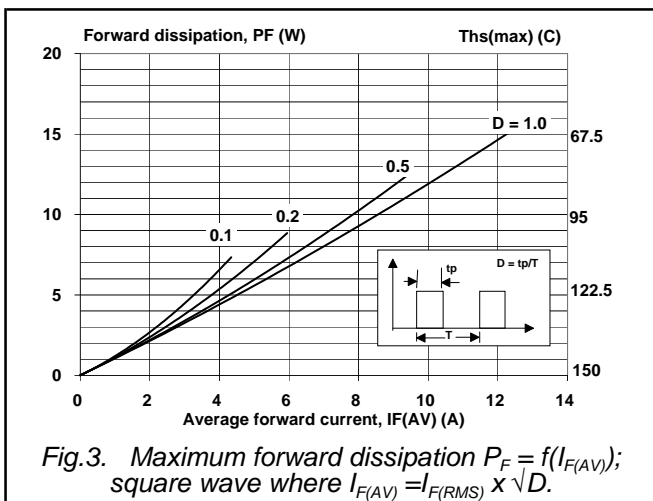
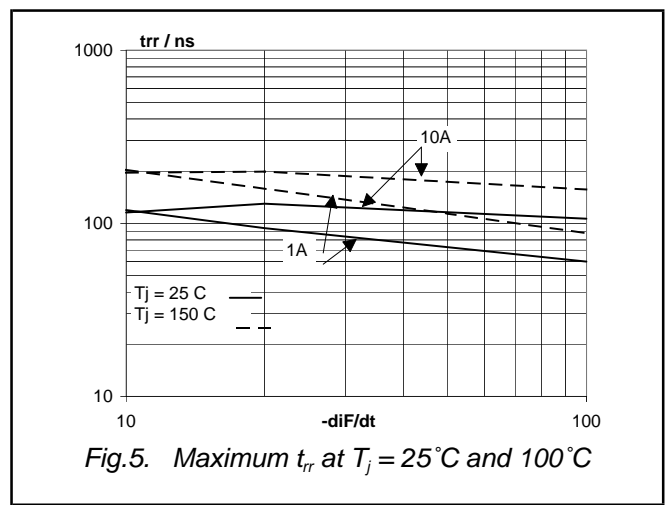
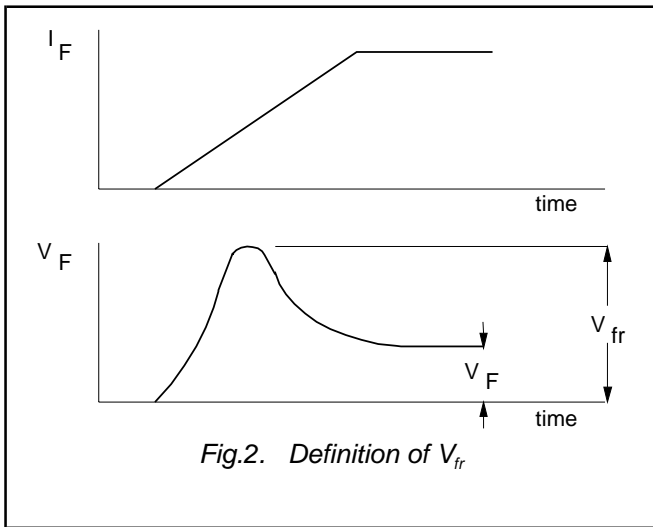
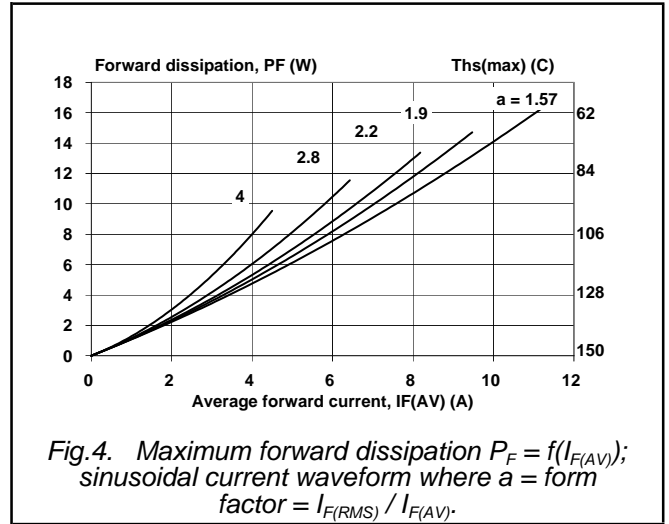
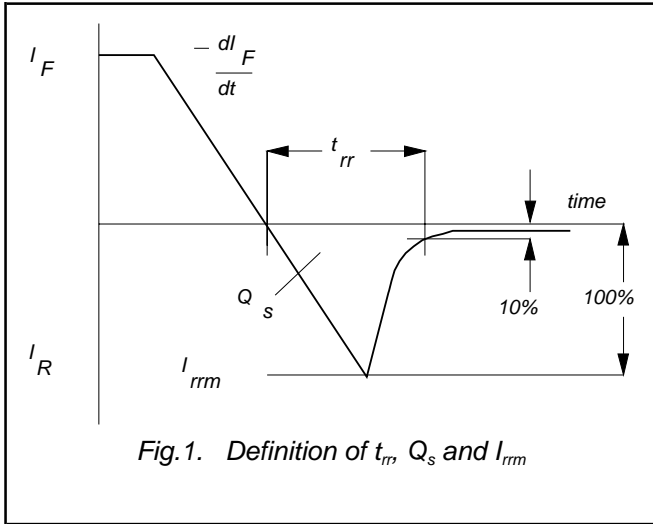

Rectifier diodes
ultrafast

BYV29X-600

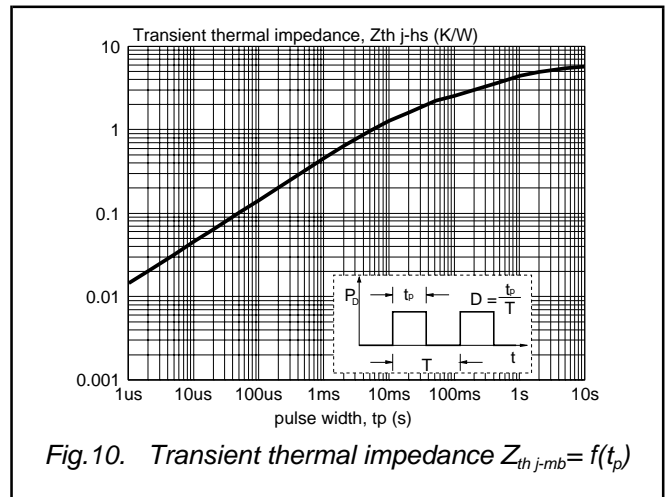
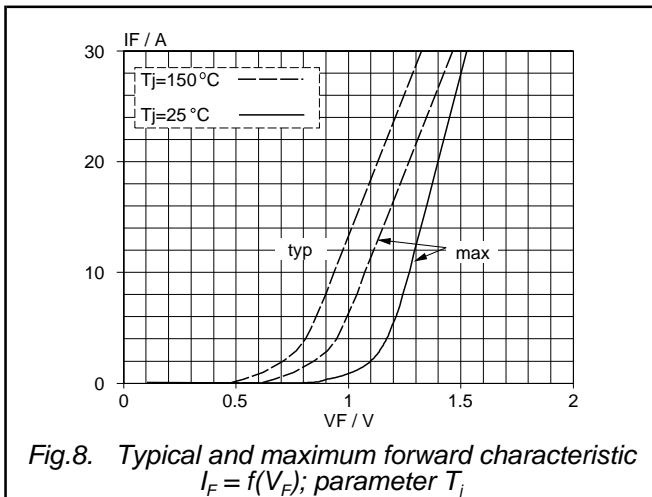
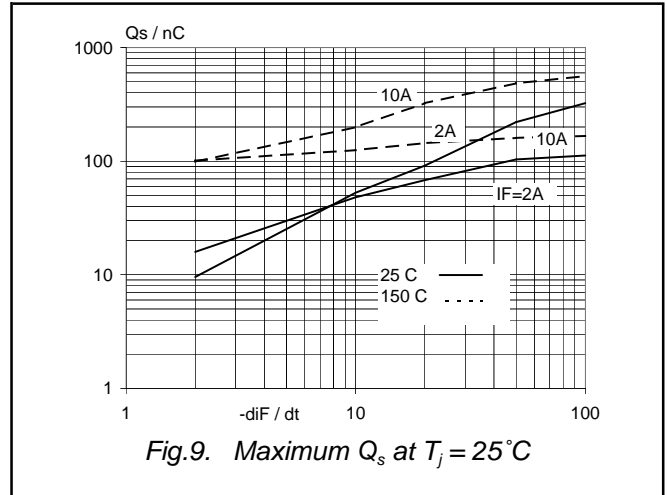
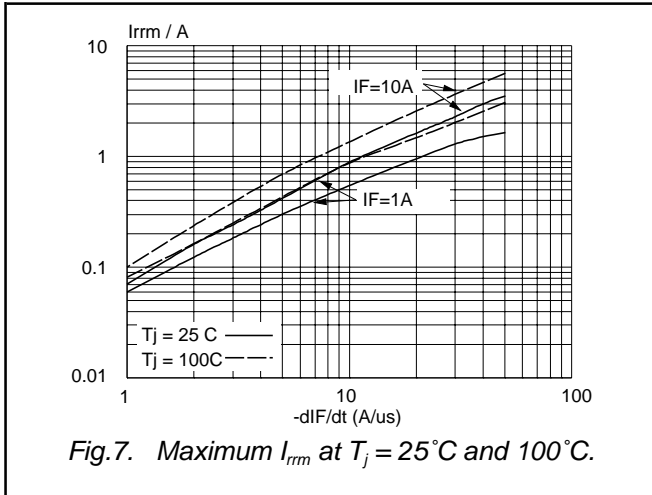

Rectifier diodes
ultrafast

BYV29X-600

MECHANICAL DATA

Dimensions in mm

Net Mass: 2 g

Plastic single-ended package; isolated heatsink mounted;
1 mounting hole; 2-leads TO-220 'full pack'

SOD113

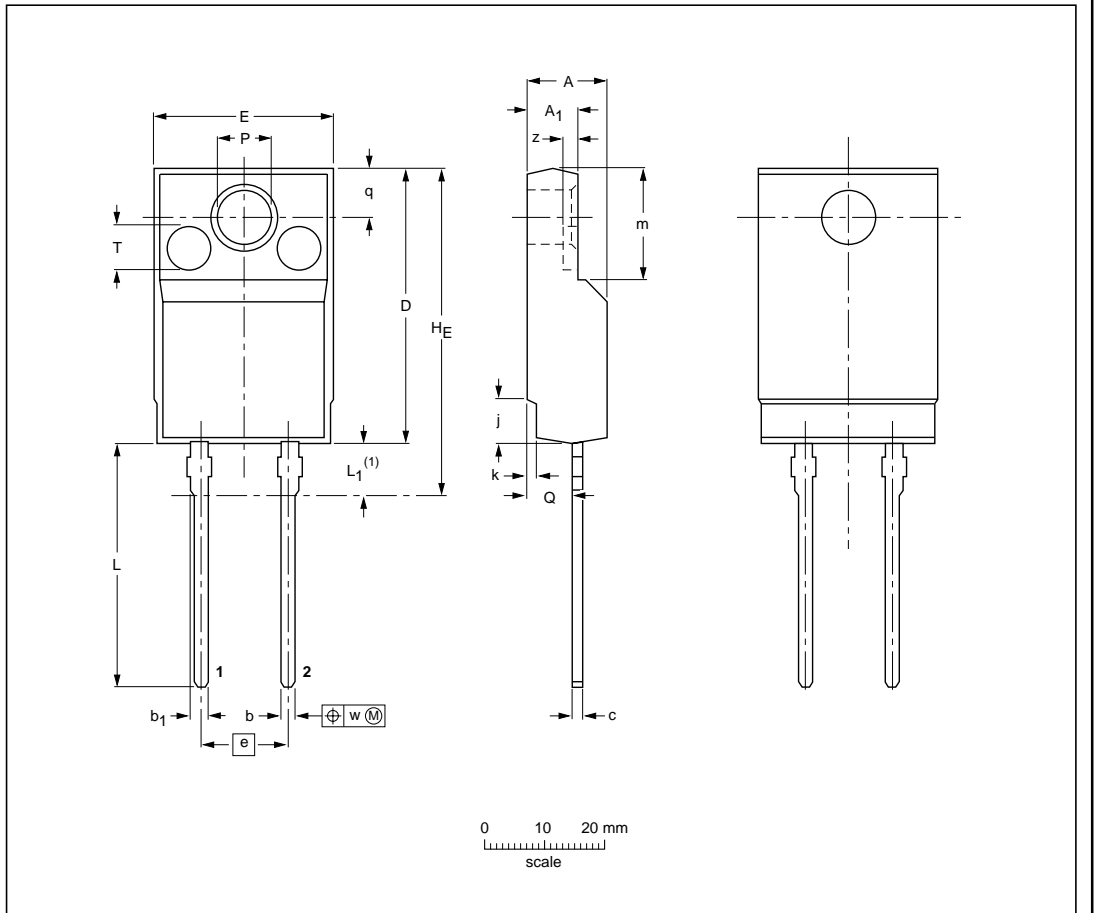

DIMENSIONS (mm are the original dimensions)

UNIT	A	A ₁	b	b ₁	c	D	E	e	H _E max.	j	k	L	L ₁ ⁽¹⁾	m	P	Q	q	T	w	z ⁽²⁾
mm	4.6 4.0	2.9 2.5	0.9 0.7	1.1 0.9	0.7 0.4	15.8 15.2	10.3 9.7	5.08	19.0	2.7 2.3	0.6 0.4	14.4 13.5	3.3 2.8	6.5 6.3	3.2 3.0	2.6 2.3	2.6	2.55	0.4	0.8

Notes

- 1. Terminals are uncontrolled within zone L₁.
- 2. z is depth of T.

OUTLINE VERSION	REFERENCES				EUROPEAN PROJECTION	ISSUE DATE
	IEC	JEDEC	EIAJ			
SOD113		2-lead TO-220				97-06-11

Fig.11. SOD113; The seating plane is electrically isolated from all terminals.

Notes

- 1. Refer to mounting instructions for F-pack envelopes.
- 2. Epoxy meets UL94 V0 at 1/8".

**Rectifier diodes
ultrafast**

BYV29X-600

DEFINITIONS

Data sheet status	
Objective specification	This data sheet contains target or goal specifications for product development.
Preliminary specification	This data sheet contains preliminary data; supplementary data may be published later.
Product specification	This data sheet contains final product specifications.
Limiting values	
Limiting values are given in accordance with the Absolute Maximum Rating System (IEC 134). Stress above one or more of the limiting values may cause permanent damage to the device. These are stress ratings only and operation of the device at these or at any other conditions above those given in the Characteristics sections of this specification is not implied. Exposure to limiting values for extended periods may affect device reliability.	
Application information	
Where application information is given, it is advisory and does not form part of the specification.	
© Philips Electronics N.V. 2000	
All rights are reserved. Reproduction in whole or in part is prohibited without the prior written consent of the copyright owner.	
The information presented in this document does not form part of any quotation or contract, it is believed to be accurate and reliable and may be changed without notice. No liability will be accepted by the publisher for any consequence of its use. Publication thereof does not convey nor imply any license under patent or other industrial or intellectual property rights.	

LIFE SUPPORT APPLICATIONS

These products are not designed for use in life support appliances, devices or systems where malfunction of these products can be reasonably expected to result in personal injury. Philips customers using or selling these products for use in such applications do so at their own risk and agree to fully indemnify Philips for any damages resulting from such improper use or sale.