

DESCRIPTION The 2SC3840 is designed for use in high speed and high voltage. It is suitable for switching regulators, DC-DC converters and ultrasonic appliance applications.

- FEATURES**
- High speed switching
 - High Voltage

ABSOLUTE MAXIMUM RATINGS

Maximum Temperatures	
Storage Temperature	-55 to +150 °C
Junction Temperature	150 °C Maximum
Maximum Power Dissipation (T _c = 25 °C)	
Total Power Dissipation	15 W
Maximum Voltages and Currents (T _a = 25 °C)	
V _{CB0} Collector to Base Voltage	600 V
V _{CEO} Collector to Emitter Voltage	600 V
V _{EBO} Emitter to Base Voltage	7.0 V
I _{C(DC)} Collector Current (DC)	1.0 A
I _{C(pulse)} Collector Current (Pulse)*	2.0 A
*PW ≤ 300 μs, Duty Cycle ≤ 10 %	

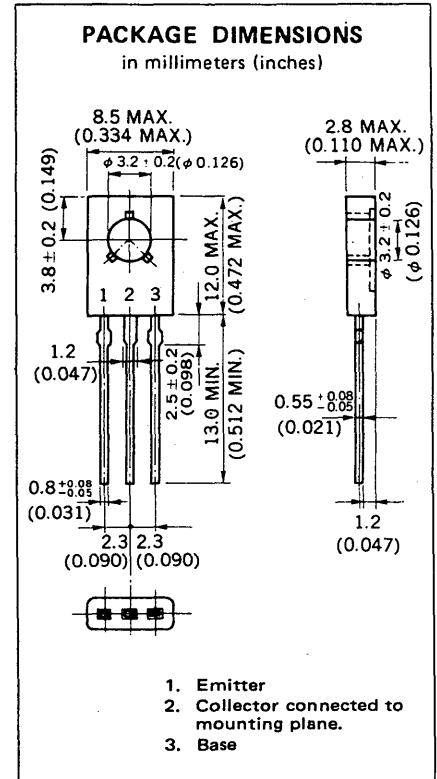

ELECTRICAL CHARACTERISTICS (T_a = 25 °C)

SYMBOL	CHARACTERISTIC	MIN.	TYP.	MAX.	UNIT	TEST CONDITIONS
t _{on}	Turn-On Time		0.1	0.5	μs	I _C = 0.5 A, I _{B1} = -I _{B2} = 0.1 A R _L = 500 Ω, V _{CC} ≈ 250 V
t _{stg}	Storage Time		4.0	5.0	μs	
t _f	Fall Time		0.2	0.5	μs	
h _{FE1} **	DC Current Gain	30		120	-	V _{CE} = 5.0 V, I _C = 0.1 A
h _{FE2} **	DC Current Gain	5			-	V _{CE} = 5.0 V, I _C = 0.5 A
V _{CE(sat)} **	Collector Saturation Voltage			1.0	V	I _C = 0.4 A, I _B = 0.08 A
V _{BE(sat)} **	Base Saturation Voltage			1.2	V	I _C = 0.4 A, I _B = 0.08 A
I _{CBO}	Collector Cutoff Current			10	μA	V _{CB} = 600 V, I _E = 0
I _{EBO}	Emitter Cutoff Current			10	μA	V _{EB} = 7.0 V, I _C = 0

**Pulsed: PW ≤ 350 μs, Duty Cycle ≤ 2 %

Classification of h_{FE1}

Rank	M	L	K
Range	30 to 60	40 to 80	60 to 120

Test Conditions: V_{CE} = 5.0 V, I_C = 0.1 A

TYPICAL CHARACTERISTICS ($T_a = 25^\circ\text{C}$)

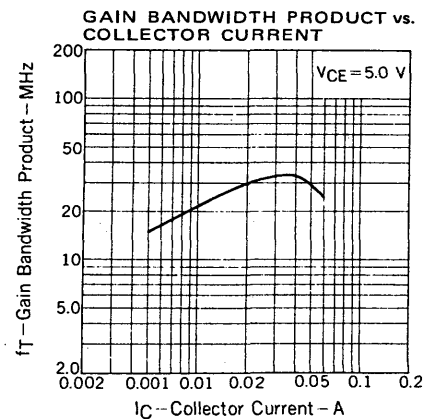
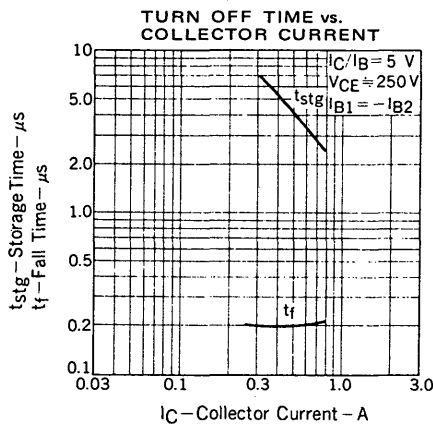
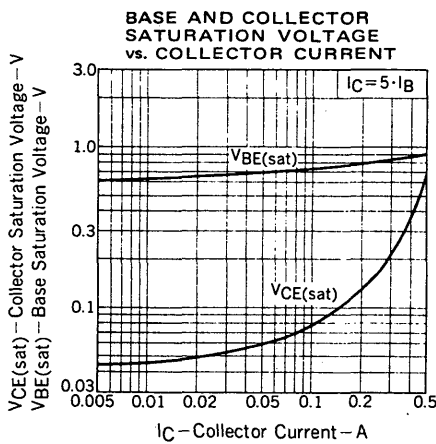
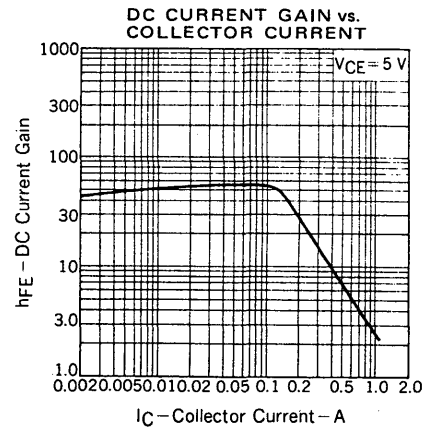
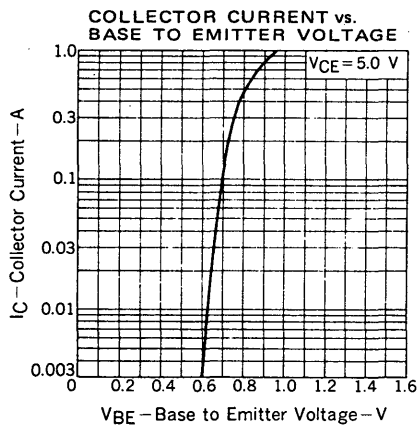
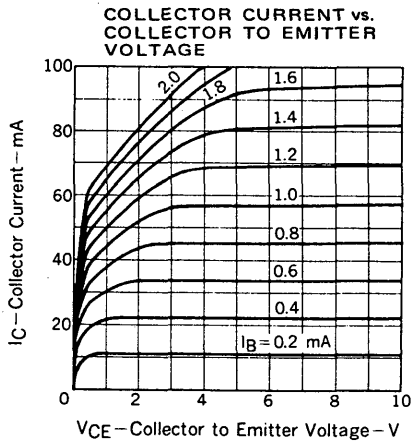
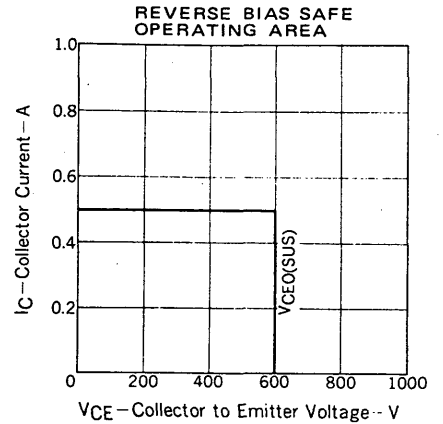
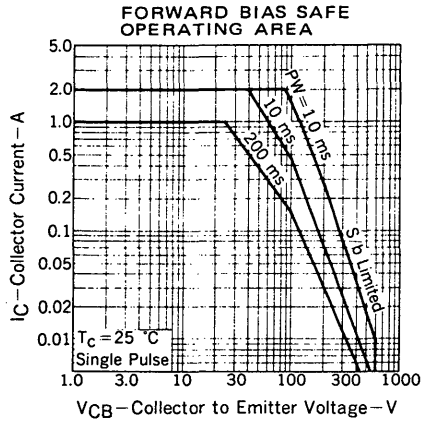
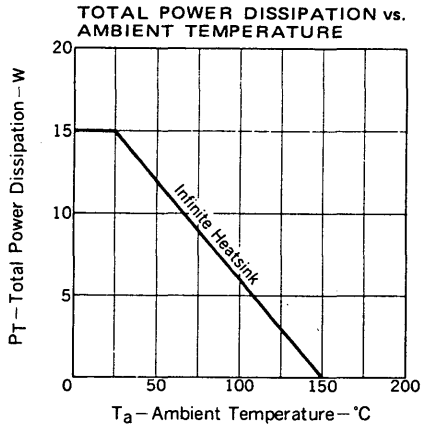

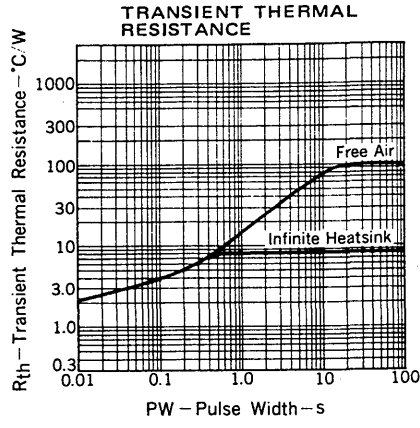
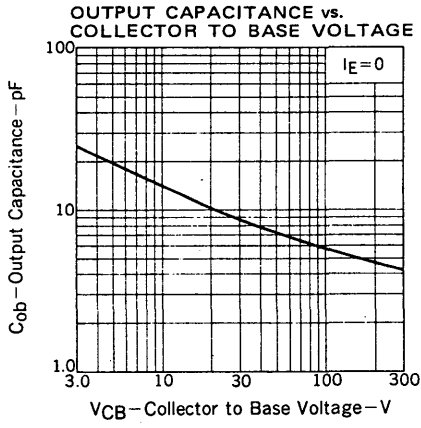

This datasheet has been downloaded from:

www.DatasheetCatalog.com

Datasheets for electronic components.