



LA1650, 1650C

Time Code Reception ICs

Overview

The LA1650 and LA1650C receive long-wave time standard broadcasts (JG2AS in Japan and DCF77 in Germany) and detect and output the time code multiplexed on the long-wave time standard broadcast signal. Clocks can automatically correct their time using the time code information received by the LA1650 and LA1650C.

Features

- Low-voltage operation ($V_{CC\text{ op}} = 1.2\text{ V}$ and higher)
- Low current drain (500 μA for @ 10 dB μV input)
- Standby mode current: Less than 1 μA
- High sensitivity (Reception is possible at $V_{in} = 10\text{ dB}\mu\text{V}$.)
- Packages: DIP18 (LA1650)
Chip (LA1650C)

Functions

- RF amplifier, rectifier, detector, time code output, standby circuit

Specifications

Maximum Ratings at $T_a = 25^\circ\text{C}$

Parameter	Symbol	Conditions	Ratings	Unit
Maximum supply voltage	$V_{CC\text{ max}}$		7.5	V
Allowable power dissipation	$P_{d\text{ max}}$	$T_a \leq 75^\circ\text{C}$	100	mW
Operating temperature	T_{opr}		-20 to +75	$^\circ\text{C}$
Storage temperature	T_{stg}		-40 to +125	$^\circ\text{C}$

Operating Conditions at $T_a = 25^\circ\text{C}$

Parameter	Symbol	Conditions	Ratings	Unit
Recommended supply voltage	V_{CC}		1.5	V
Operating supply voltage range	$V_{CC\text{ OP}}$		1.2 to 6.5	V

Package Dimensions

unit: mm

3007A-DIP18

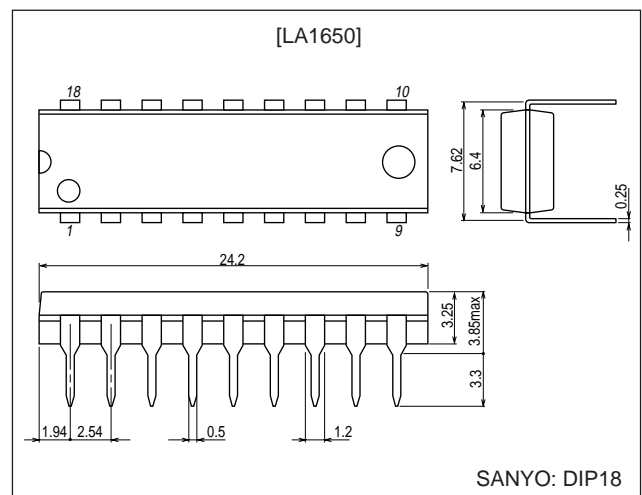

■ Any and all SANYO products described or contained herein do not have specifications that can handle applications that require extremely high levels of reliability, such as life-support systems, aircraft's control systems, or other applications whose failure can be reasonably expected to result in serious physical and/or material damage. Consult with your SANYO representative nearest you before using any SANYO products described or contained herein in such applications.

■ SANYO assumes no responsibility for equipment failures that result from using products at values that exceed, even momentarily, rated values (such as maximum ratings, operating condition ranges, or other parameters) listed in products specifications of any and all SANYO products described or contained herein.

SANYO Electric Co.,Ltd. Semiconductor Company

TOKYO OFFICE Tokyo Bldg., 1-10, 1 Chome, Ueno, Taito-ku, TOKYO, 110-8534 JAPAN

LA1650, 1650C

Operating Characteristics at $T_a = 25^\circ\text{C}$, $V_{CC} = 1.5\text{ V}$, with the pin 5 used as V_{CC} , in the specified test circuit, unless otherwise specified. Values in parentheses refer to the LA1650C. (Using the Yamaichi Electronics IC37N-1803 socket.)

Parameter	Symbol	Conditions	Ratings			Unit
			min	typ	max	
[Overall Characteristics]						
Current drain	I_{CCO}	No input	400	540	680	μA
Operating current	I_{CC}	$f_{IN} = 40\text{ kHz}$, $V_{IN} = 10\text{ dB}\mu\text{V}$	370	510	650	μA
Standby current	ISTB	With the pin 5 (pad 5) voltage at 0 V		0.1	1.0	μA
[Amplifier Input Characteristics]						
Input impedance	ZI	1pin (PAD1)		450		$\text{k}\Omega$
Input frequency range	FIN		37.5		80.0	kHz
Minimum input voltage	$V_{IN\text{ min}}$	Pin 1 (pad 1) input		1		μVrms
Maximum input voltage	$V_{IN\text{ max}}$	Pin 1 (pad 1) input		100		mVrms
[Amplifier Output Characteristics] With pin 1 (pad 1) as the input pin, $f_{IN} = 40\text{ kHz}$						
Output voltage (1)	V_{O1}	No input, the pin 11 output	10	20	34	mVrms
Output voltage (2)	V_{O2}	$V_{IN} = 10\text{ dB}\mu\text{V}$, the pin 11 output	15	28	48	mVrms
Output voltage (3)	V_{O3}	$V_{IN} = 20\text{ dB}\mu\text{V}$, the pin 11 output	25	40	62	mVrms
Output voltage (4)	V_{O4}	$V_{IN} = 80\text{ dB}\mu\text{V}$, the pin 11 output	35	48	88	mVrms
[TCO Output Characteristics] With pin 1 (pad 1) as the input pin, $f_{IN} = 40\text{ kHz}$						
Output voltage (high)	V_{OH}	No input	1.40	1.45		V
Output voltage (low)	V_{OL}	$V_{IN} = 10\text{ dB}\mu\text{V}$		0.05	0.10	V
Output pulse width (500 ms input)	T500	$V_{IN} = 0$ to $100\text{ dB}\mu\text{V}$, AM modulation (1 Hz square wave, duty = 50%, 100% modulation)	480	500	650	ms
Output pulse width (800 ms input)	T800	$V_{IN} = 0$ to $100\text{ dB}\mu\text{V}$, AM modulation (1 Hz square wave, duty = 80%, 100% modulation)	750	800	970	ms
Output pulse width (200 ms input)	T200	$V_{IN} = 0$ to $100\text{ dB}\mu\text{V}$, AM modulation (1 Hz square wave, duty = 20%, 100% modulation)	180	200	400	ms

LA1650, 1650C

Chip Specifications (LA1650C)

Chip size	1.41 × 2.06	mm ²
Chip thickness	330 (±20)	μm
Pad size	140 × 140	μm ²
Pad opening	115 × 115	μm ²

Pad Coordinates (LA1650C)

PAD	Pad	Symbol	X-axis	Y-axis
P1	Amplifier (1) input	INPUT	585	1914
P2	AGC	AGC2	385	1914
P3		AGC1	154	1734
P4	V _{CC}	V _{CC}	158	1410
P5	Standby mode	PON	154	1221
P6	Amplifier (1) output	AMP1_OUT1	154	711
P7		AMP1_OUT2	164	201
P8	Amplifier (2) input	AMP2_IN1	397	154
P9		AMP2_IN2	597	154
P10	Amplifier (2) output	AMP2_OUT2	864	154
P11		AMP2_OUT1	1086	154
P12	REC input	REC_IN1	1264	361
P13		REC_IN2	1264	531
P14	REC output	REC_OUT1	1264	701
P15	DEC input	DEC_IN1	1264	1455
P16	DEC output	TCO	1264	1625
P17	GND	GND	1113	1914
P18	REG	REG	849	1914

Note: The origin (0, 0) is taken to be the left lower corner in the metal pattern figure on the next page.
The pad coordinates are the values of the coordinates of the center of the pad.

Metal Pattern Figure

Chip size
X : 1.41
Y : 2.06

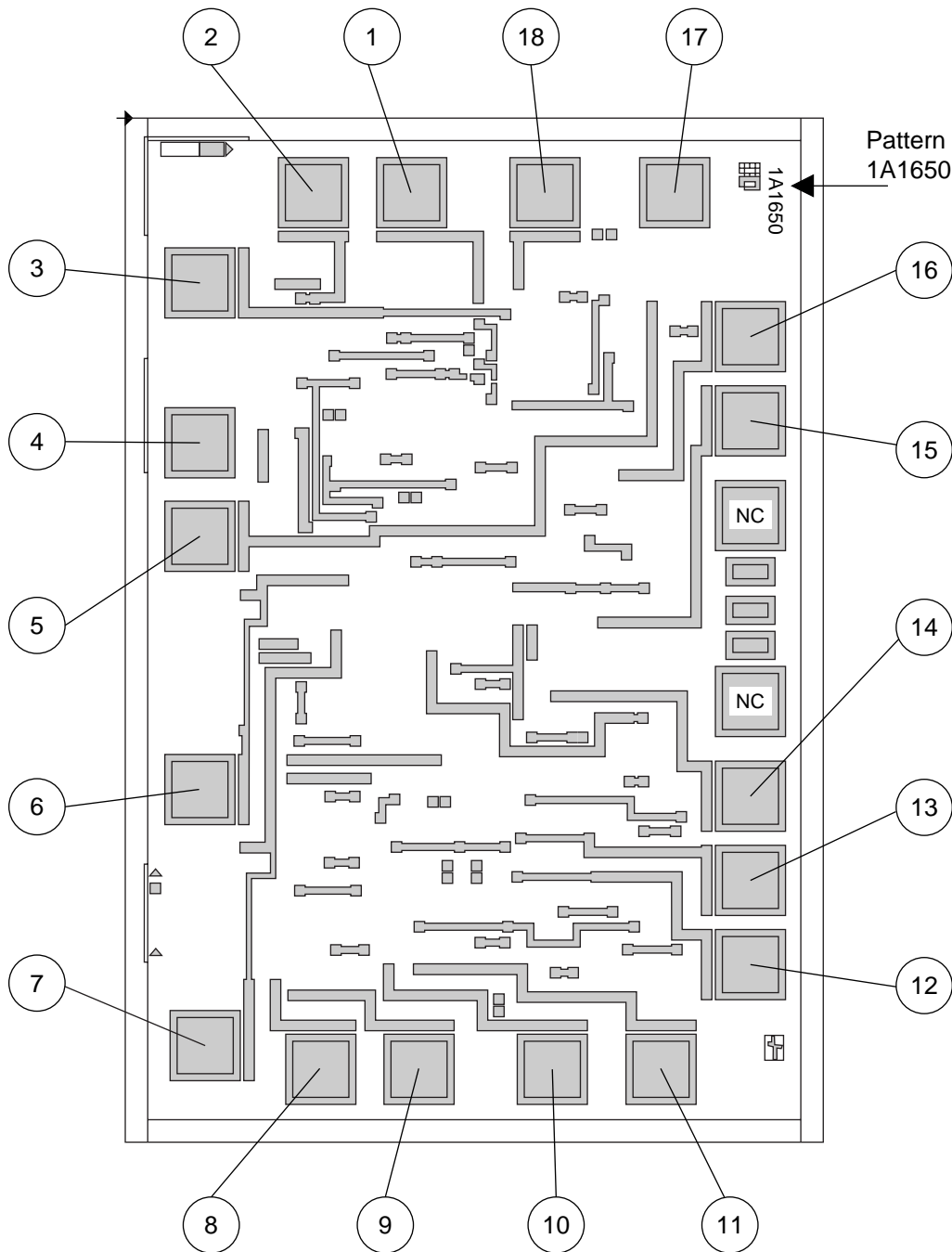

A12842

Block Diagram and Test Circuit

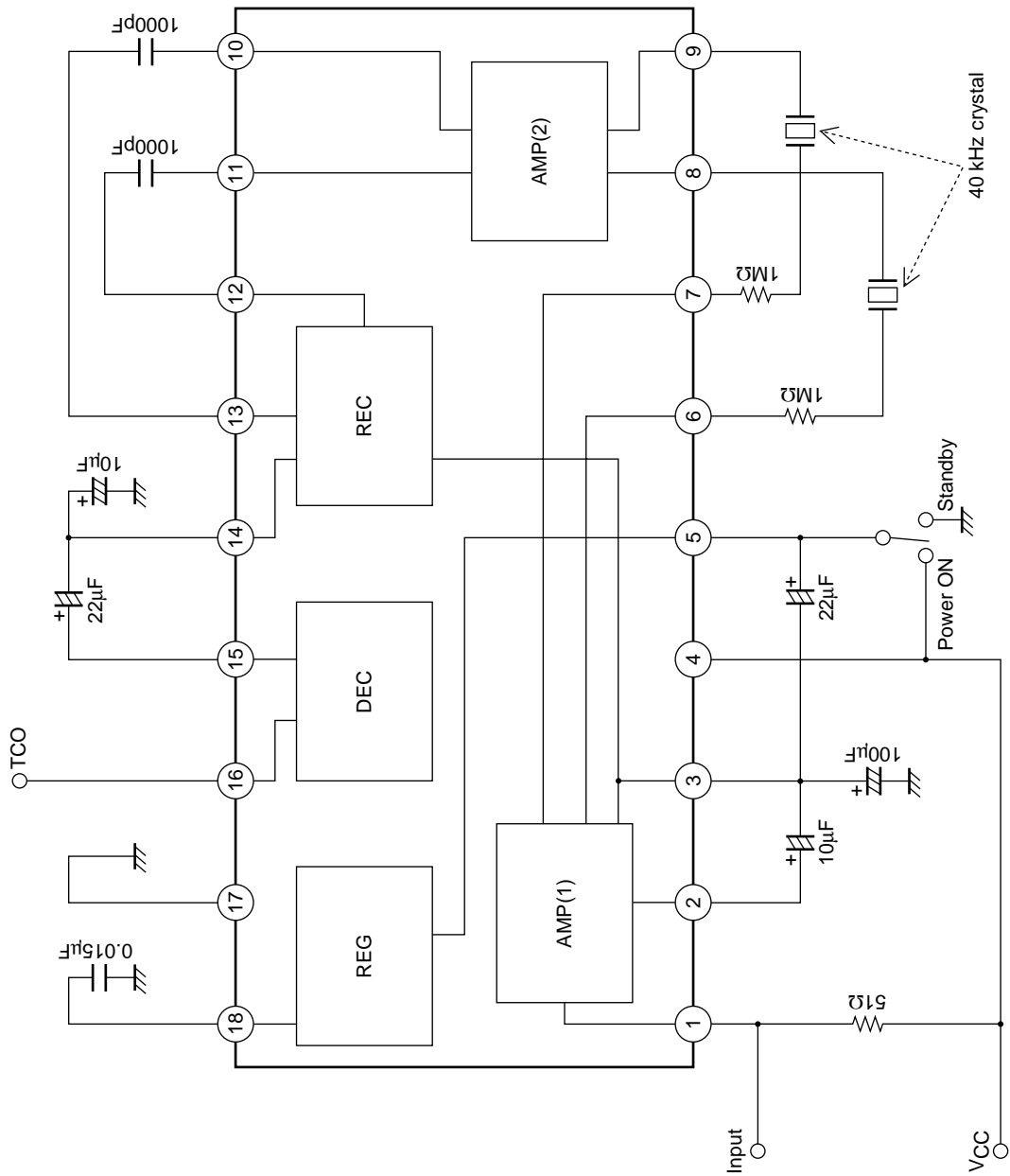

A12758

LA1650, 1650C

Pin Functions ($V_{CC} = 1.5\text{ V}$)

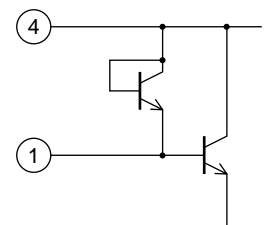
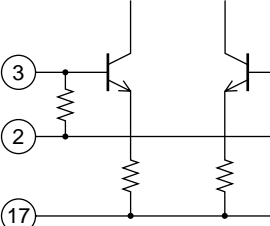
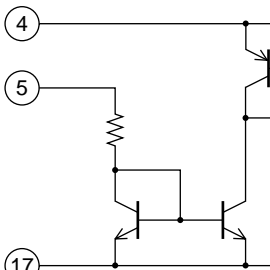
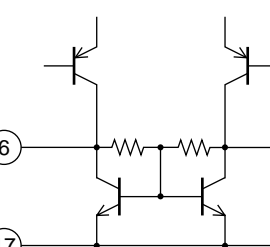
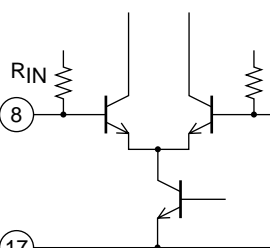
Pin No.	Function	No-signal voltage (V)	Notes	Equivalent circuit
1	Amplifier (1) input	1.5	<p>The input impedance, Z_i, is $450\text{ k}\Omega$.</p> <p>Connect the antenna coil between pins 1 and 4.</p> <p>Recommended coil: ACL-80 (Sumida Electronics)</p>	 <p style="text-align: right;">A12759</p>
2 3	AGC (1) input AGC (2) input	0.6 0.6	<p>The AGC operating speed is determined by the capacitor connected between pin 3 and ground.</p>	 <p style="text-align: right;">A12760</p>
4	V_{CC}	1.5		
5	PON	1.5	<p>This LA1650 operates normally with pin 5 at V_{CC}. The device goes to standby mode ($I_{CC} \leq 1\text{ }\mu\text{A}$) when this pin is pulled to ground.</p>	 <p style="text-align: right;">A12761</p>
6 7	Amplifier (1) output	0.7	<p>Connect the crystal oscillator elements between pins 6 and 8, and pins 7 and 9.</p> <p>Recommended element: VTC-200 (Seiko Instruments) 40 kHz, 12.5 pF</p>	 <p style="text-align: right;">A12762</p>
8 9	Amplifier (2) input	0.8	<p>$R_{IN} = 20\text{ k}\Omega$</p>	 <p style="text-align: right;">A12763</p>

Continued on next page.

LA1650, 1650C

Continued from preceding page.

Pin No.	Function	No-signal voltage (V)	Notes	Equivalent circuit
10 11	Amplifier (2) output	0.7	Emitter-follower output	<p style="text-align: right;">A12764</p>
12 13	REC input	0.8	Full-wave rectifier circuit input $R_{IN} = 20\text{ k}\Omega$	<p style="text-align: right;">A12765</p>
14	REC output	0.8	Full-wave rectifier circuit output $R_{OUT} = 75\text{ k}\Omega$ High-frequency components are smoothed by the capacitor connected between pin 14 and ground.	<p style="text-align: right;">A12766</p>
15	DEC input	0.7	Wave shaping circuit input	<p style="text-align: right;">A12767</p>
16	DEC output	—	Wave shaping circuit output $R_{OUT} = 100\text{ k}\Omega$ This pin outputs the time code. (Inverted output)	<p style="text-align: right;">A12768</p>
17	GND	0		
18	REG	0.8	$V_{reg} = V_{CC} - 0.7\text{ V}$	<p style="text-align: right;">A12769</p>

Block Functional Descriptions

Amplifier Block

The radio signal picked up by the bar antenna (resonant frequency: 40 kHz for Japan) is amplified by amplifier 1 which includes an AGC function, and is passed through a 40 kHz crystal element used as a bandpass filter. This signal is then amplified further by amplifier 2. The total gain from the amplifier 1 input to the amplifier 2 output is 90 dB when the AGC is disabled.

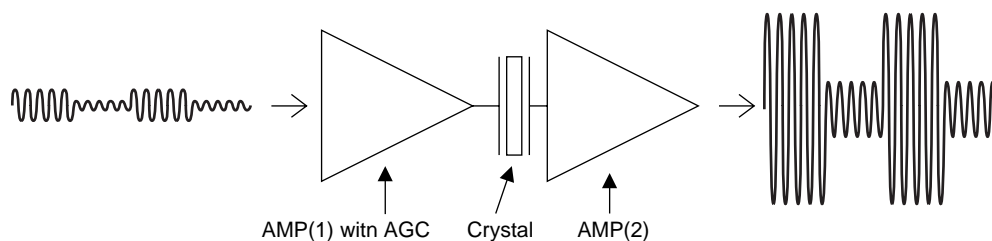

A12770

Since amplifier 1 has frequency characteristics of -3 dB at $f_c = 80$ kHz from the output level at $f_c = 40$ kHz, and amplifier 2 has frequency characteristics that are flat up to 100 kHz, this IC can support the standard radio frequencies used in any country simply by changing bar antenna and the resonant frequency of the crystal used.

REC Block

The 40 kHz carrier signal output from amplifier 2 is input to the REC block through a 1000 pF capacitor. The REC block input impedance is 20 k Ω , which, in conjunction with the 1000 pF capacitor, forms a high-pass filter with a cutoff frequency of about 8 kHz. The carrier is full-wave rectified within the REC block, split into two signal systems, and output. One signal system passes through a low-pass filter with a time constant of about 1 s and is then input to the DEC block. The other passes through a low-pass filter with an even larger time constant and is fed back to amplifier 1 as the AGC control voltage (pin 3: a DC voltage).

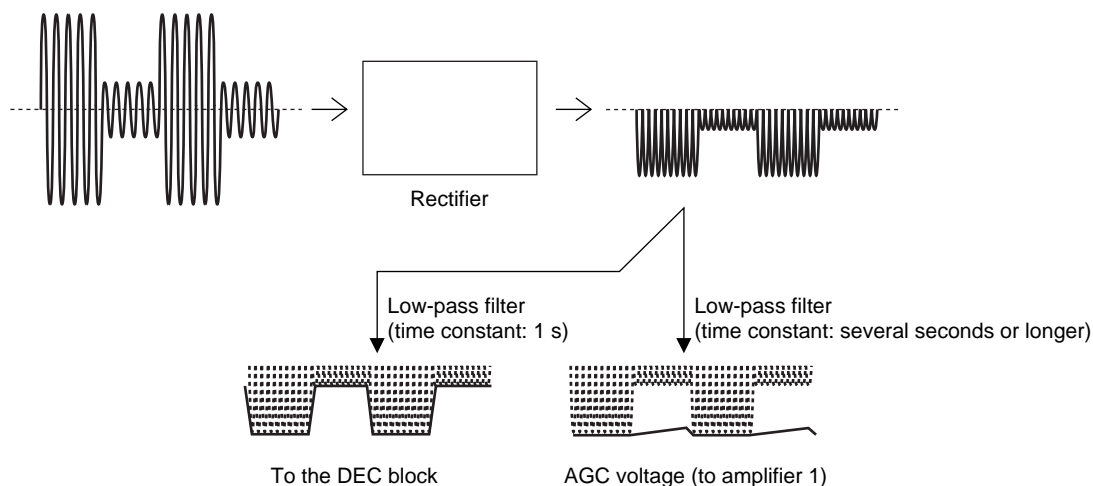

A12771

The AGC voltage is set up to be about 0.6 V when there is no input present. However, since charging is performed by a small current of only a few μ A, we recommend precharging if the LA1650 is used for reception immediately after power is applied. (Charge to about 1.0 V for about 100 ms.)

DEC Block

The time code signal (1 Hz) from which the 40 kHz carrier has been removed is input to the DEC block, and wave shaping is applied to create a serial output signal in which 1 and 0 have the levels V_{CC} and ground, respectively.

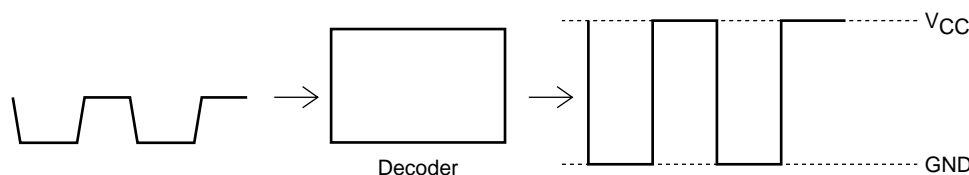

A12772

Antenna (prototype) Specifications

Model number: ACL-80 (Sumida Electronics)
 Prototype number: 74M-656
 Inductance: 588 μ H (reference value at 10 kHz)
 Tuning frequency: 40 kHz
 Mounting capacitance: 27000 pF
 Winding: UEW 0.35
 Number of windings: 94 turns (4-3)

* Consult with your Sanyo representative before starting mass production.

Pin Connections (back surface)

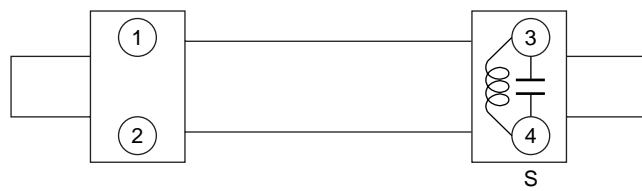

A12773

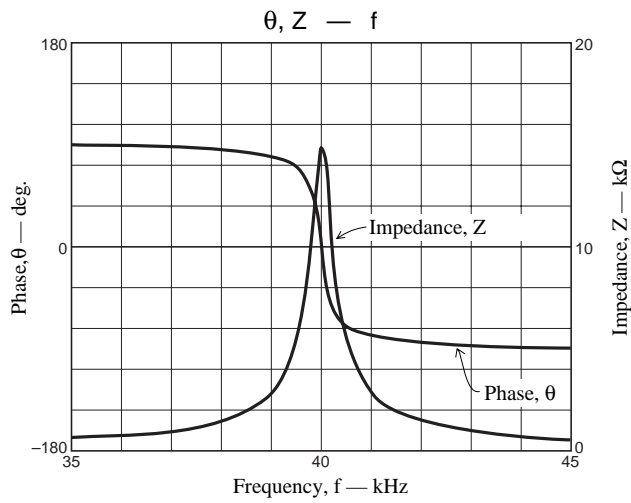

LA1650, 1650C

Antenna Dimensions (trigonometric)

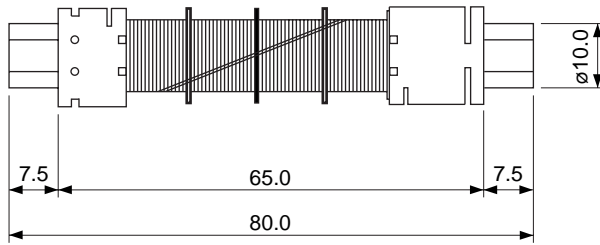
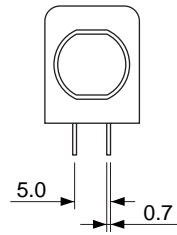
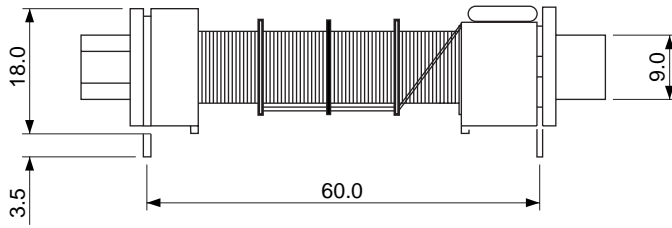
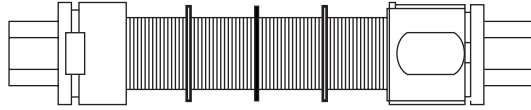

A12843

Sample Application Circuit

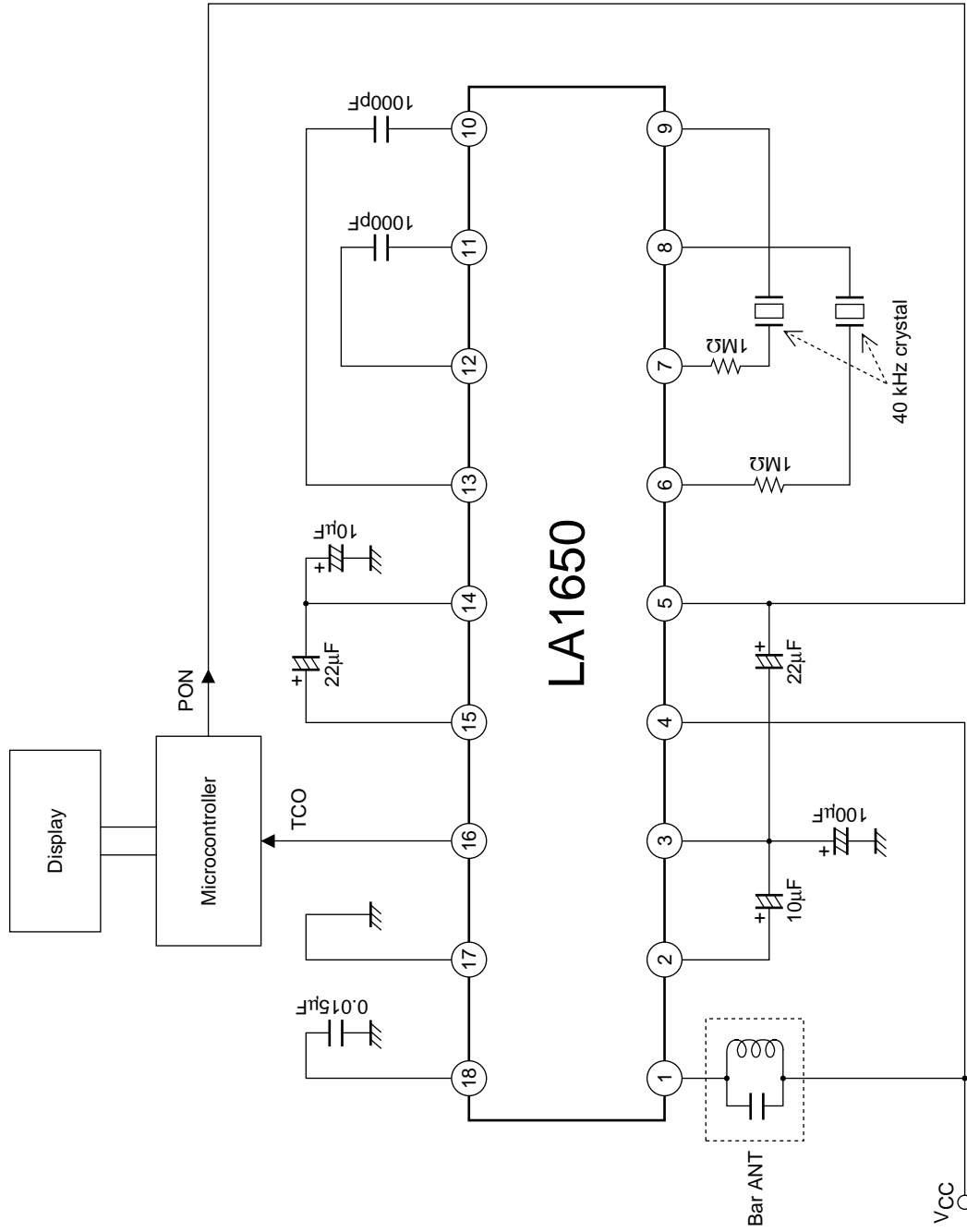

A12774

LA1650 Evaluation Procedure

Two relatively simple techniques for measuring the sensitivity index are (1) to input the signal generator output directly to the IC (see figure 1), and (2) to use an antenna as shown in figure 2.

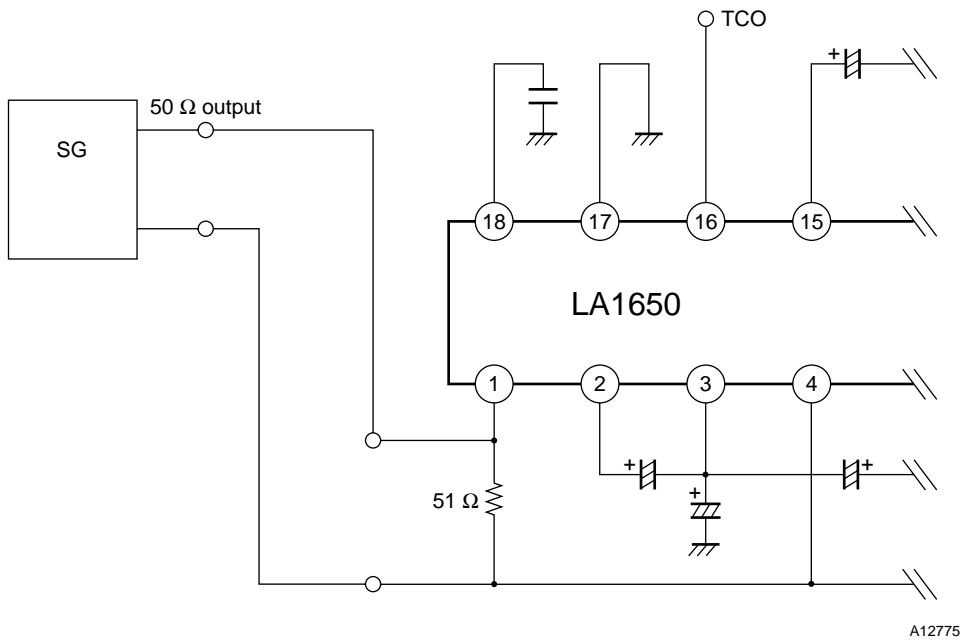

Figure 1 Direct Signal Generator Input to the IC

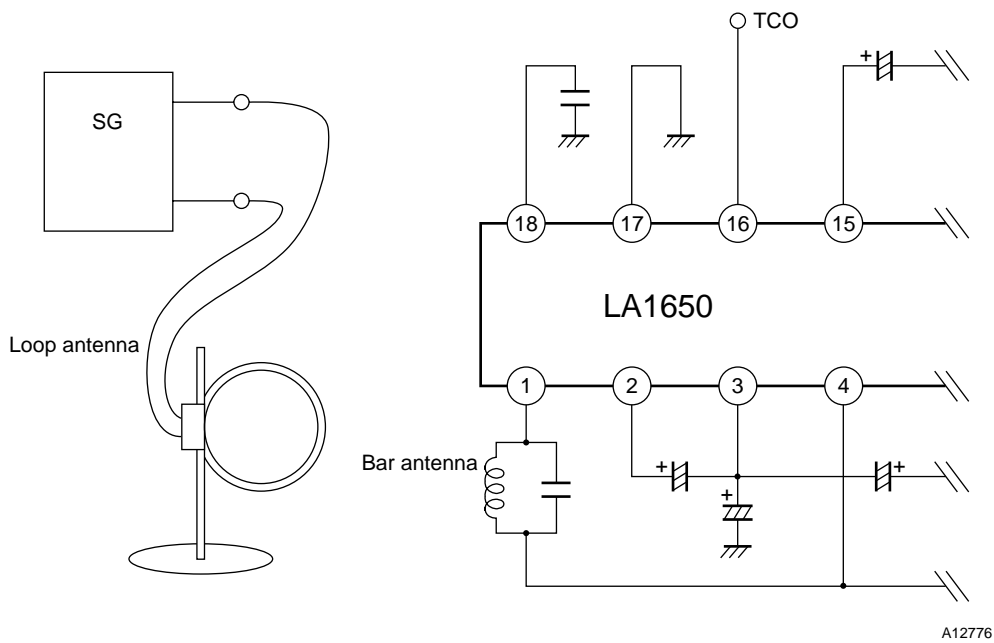

Figure 2 Antenna to Antenna Signal Input

LA1650, 1650C

The following three techniques are practical test procedures. Note that since the output from the LA1650 pin 16 is inverted from the value of the time code, an inverter must be inserted between the output and the microcontroller.

- Continuously output a signal with the value 1 ($f_c = 40$ kHz, AM modulation (90%), $f_m = 1$ Hz (square wave, duty = 50%)) and read out the value 1 from the LA1650. Then, lower the signal generator level until the LA1650 can no longer correctly output the 1 level. The minimum signal generator level at which correct reception occurs is the sensitivity.

When monitoring the LA1650 output signal with a microcontroller, monitor the output pulse width for the range listed in table 1. The output signal should be observed to be a 1 Hz signal, with a period of 1000 ± 25 ms. (See figure 3.)

Table 1 Signal Value 1 Range

Item	min	typ	max	unit
Output pulse width (500 ms input)	480	500	650	ms

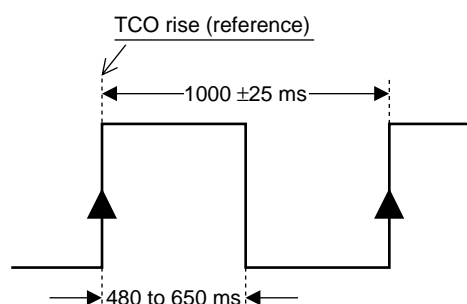

A12777

Figure 3 Time Code Value 1 Signal Output

- Continuously output a signal with the value 0 ($f_c = 40$ kHz, AM modulation (90%), $f_m = 1$ Hz (square wave, duty = 80%)) and read out the value 0 from the LA1650. Then, lower the signal generator level until the LA1650 can no longer correctly output the 0 level. The minimum signal generator level at which correct reception occurs is the sensitivity.

When monitoring the LA1650 output signal with a microcontroller, monitor the output pulse width for the range listed in table 2. The output signal should be observed to be a 1 Hz signal, with a period of 1000 ± 25 ms. (See figure 4.)

Table 2 Signal Value 0 Range

Item	min	typ	max	unit
Output pulse width (800 ms input)	750	800	970	ms

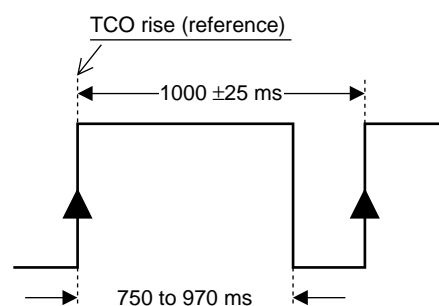

A12778

Figure 4 Time Code Value 0 Signal Output

- Create a simulated time standard radio signal ($f_c = 40$ kHz, AM modulation (90%), $f_m = 1$ Hz time code (this signal you will have to create yourself)) and verify that the time is modified correctly. The sensitivity is then the minimum level for which the time is modified correctly.

When monitoring the LA1650 output signal with a microcontroller, monitor the output pulse width for the ranges listed in table 3. The output signal should be observed to be a 1 Hz signal, with a period of 1000 ± 25 ms. (See figure 4.)

Table 3 Time Code Signal Output Ranges

Item	min	typ	max	unit
Output pulse width (500 ms input)	480	500	650	ms
Output pulse width (800 ms input)	750	800	970	ms
Output pulse width (200 ms input)	180	200	400	ms

- Specifications of any and all SANYO products described or contained herein stipulate the performance, characteristics, and functions of the described products in the independent state, and are not guarantees of the performance, characteristics, and functions of the described products as mounted in the customer's products or equipment. To verify symptoms and states that cannot be evaluated in an independent device, the customer should always evaluate and test devices mounted in the customer's products or equipment.
- SANYO Electric Co., Ltd. strives to supply high-quality high-reliability products. However, any and all semiconductor products fail with some probability. It is possible that these probabilistic failures could give rise to accidents or events that could endanger human lives, that could give rise to smoke or fire, or that could cause damage to other property. When designing equipment, adopt safety measures so that these kinds of accidents or events cannot occur. Such measures include but are not limited to protective circuits and error prevention circuits for safe design, redundant design, and structural design.
- In the event that any or all SANYO products (including technical data, services) described or contained herein are controlled under any of applicable local export control laws and regulations, such products must not be exported without obtaining the export license from the authorities concerned in accordance with the above law.
- No part of this publication may be reproduced or transmitted in any form or by any means, electronic or mechanical, including photocopying and recording, or any information storage or retrieval system, or otherwise, without the prior written permission of SANYO Electric Co., Ltd.
- Any and all information described or contained herein are subject to change without notice due to product/technology improvement, etc. When designing equipment, refer to the "Delivery Specification" for the SANYO product that you intend to use.
- Information (including circuit diagrams and circuit parameters) herein is for example only; it is not guaranteed for volume production. SANYO believes information herein is accurate and reliable, but no guarantees are made or implied regarding its use or any infringements of intellectual property rights or other rights of third parties.

This catalog provides information as of March, 2000. Specifications and information herein are subject to change without notice.