

P/N	FSLC-C090U	DATE.	July/1/2004
DWN.	Y.Tanaka	DATA-No.	LC-FSLC-C090U-0407A

4532 Size

800-1000MHz Band
Chip Multilayer 90deg.3dB Splitter

FSLC-C090U

FSLC-C090U Sample Data

P/N	FSLC-C090U	DATE.	July/1/2004
DWN.	Y.Tanaka	DATA-No.	LC-FSLC-C090U-0407A

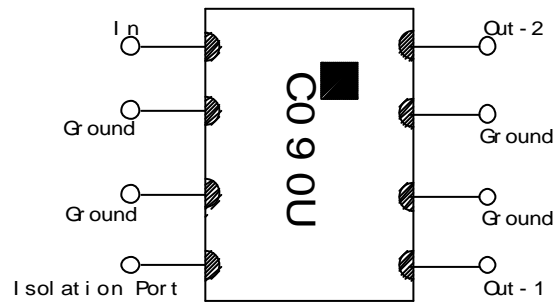
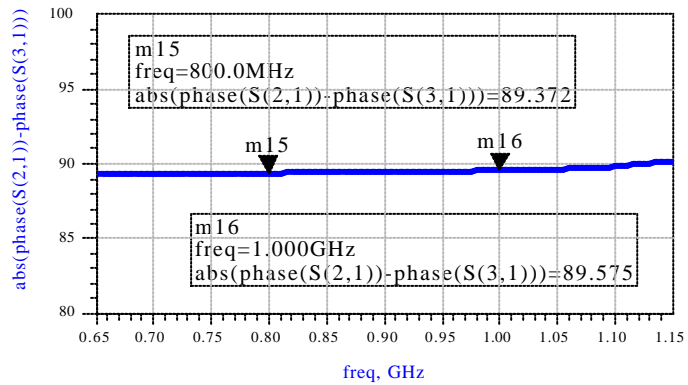
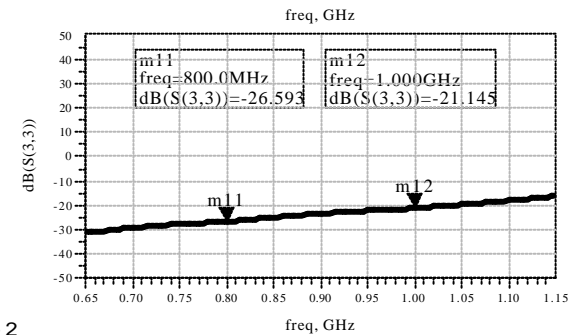
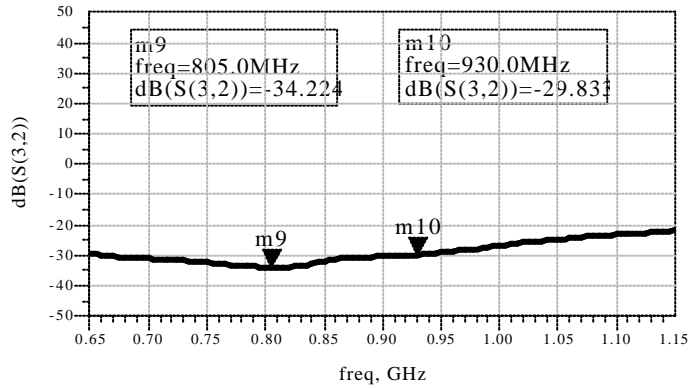
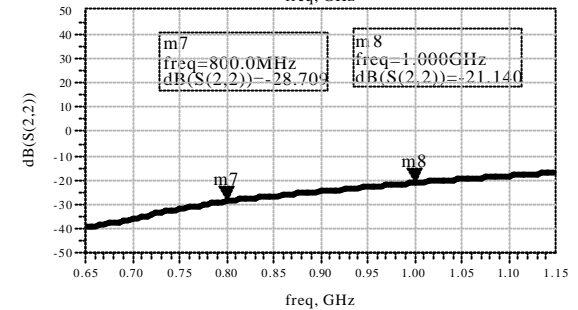
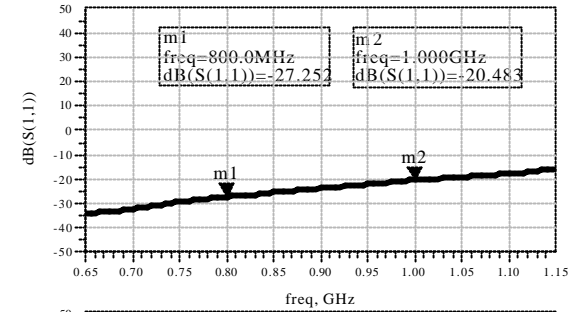
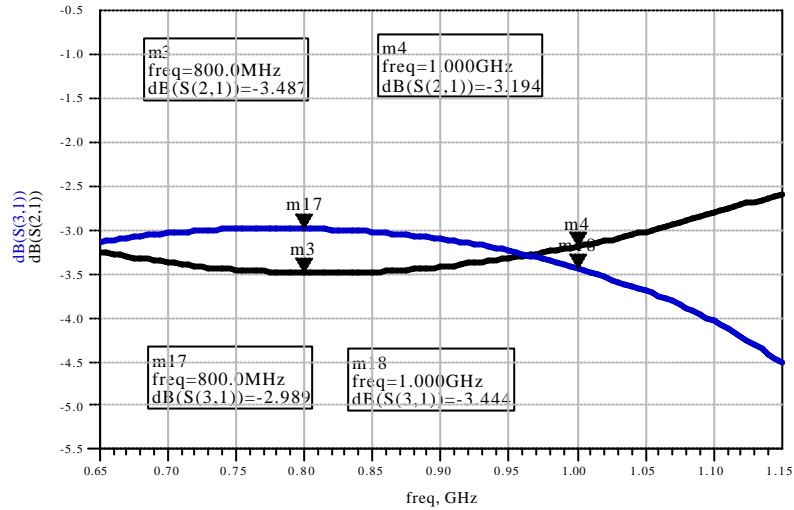

P/N	FSLC-C090U	DATE.	Jyly/1/2004
DWN.	Y.Tanaka	DATA-No.	LC-FSLC-C090U-0407A

Foot Pattern

