

14 cm (5.5 Type), 320 × 240 Pixels, Full color, RGB separate input  
NTSC Composite input, Incorporated backlight with inverter

NL3224AC35-06 is a TFT (thin film transistor) active matrix color liquid crystal display (LCD) comprising amorphous silicon TFT attached to each signal electrode, a driving circuit and a backlight. NL3224AC35-06 has a built-in backlight.

The 14 cm diagonal display area contains 320×240 pixels and can display full-color simultaneously.

## 1. FEATURES

- Full color
- Analog RGB interface
- NTSC Composite input
- Low reflection
- High luminance
- Reversible horizontal and vertical scanning
- 234/240 line display
- Incorporated edge type backlight
- Designed viewing direction: 10 and 2 o'clock
- Replaceable backlight

## 2. APPLICATIONS

- Car navigations
- TV monitors
- Video games
- Monitors for process controller

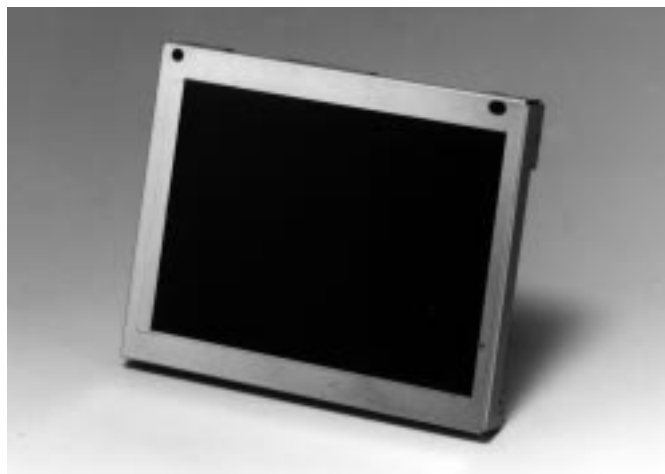

The information in this document is subject to change without notice.

### 3. STRUCTURE AND FUNCTIONS

A TFT color LCD module comprises a TFT LCD panel, LSIs for driving liquid crystal, and a backlight. The TFT LCD panel is composed of a TFT array glass substrate superimposed on a color filter glass substrate with liquid crystal filled in the narrow gap between two substrates. The backlight apparatus is located on the backside of the LCD panel.

RGB (Red, Green, Blue) data signals are sent to LCD panel drivers after modulation into suitable forms for active matrix addressing through signal processor.

Each of the liquid crystal cells acts as an electro-optical switch that controls the light transmission from the backlight by a signal applied to a signal electrode through the TFT switch.

### 4. OUTLINE OF CHARACTERISTICS (at room temperature)

Display area	111.36 (H) × 83.52 (V) mm
Drive system	a-Si TFT active matrix
Display colors	Full-color
Number of pixels	320 × 240
Pixel arrangement	RGB vertical stripe
Pixel pitch	0.348 (H) × 0.348 (V) mm
Module size	134.0 (H) × 110.0 (V) × 16.5 max.(D) mm
Weight	285 g (typ.)
Contrast ratio	85:1 (typ.)
Viewing angle (more than the contrast ratio of 10:1)	
	<ul style="list-style-type: none"> <li>• Horizontal : 50° (typ. left side, right side) fix down 5° direction</li> <li>• Vertical : 25° (typ. up side), 25° (typ. down side) fix left or right 30° direction</li> </ul>
Designed viewing direction	
	<ul style="list-style-type: none"> <li>• wider viewing angle with contrast ratio : down side (6 o'clock)</li> <li>• wider viewing angle without image reversal : up side (2 and 10 o'clock)</li> <li>• optimum grayscale (<math>\gamma=2.2</math>) : perpendicular</li> </ul>
Color gamut	50% (typ. center to NTSC)
Response time	60 ms (max.), "white" to "black"
Luminance	250 cd/m <sup>2</sup> (typ.)
Signal system	Analog RGB signals, synchronous signals (Hsync, Vsync), composite signal
Supply voltage	9.5 V × 2
Backlight	Edge light type, one fluorescent lamp (cold cathode type)
Power consumption	8.0 W (typ.)

5. BLOCK DIAGRAM

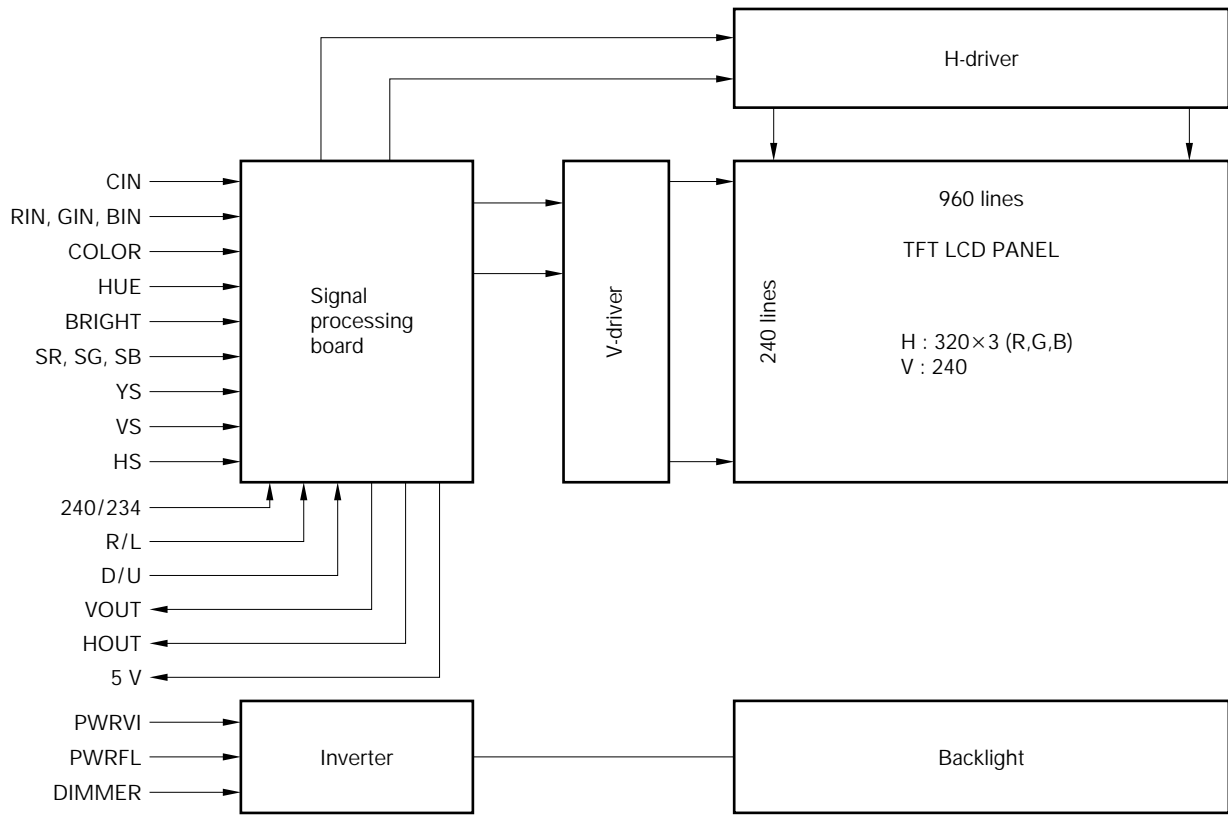

## 6. SPECIFICATION

## 6.1 GENERAL SPECIFICATIONS

Item	Specifications	Unit
Module size	134.0±0.5 (H) × 110.0±0.5 (V) × 16.5 max. (D)	mm
Display area	111.36 (H) × 83.52 (V)	mm
Number of dots	320 × 3 (H) × 240 (V)	dot
Dot pitch	0.116 (H) × 0.348 (V)	mm
Pixel pitch	0.348 (H) × 0.348 (V)	mm
Pixel arrangement	RGB (Red, Green, Blue) vertical stripe	-
Display colors	Full-color	color
Weight	330 (max.)	g

note : An inverter is incorporated with the module.

## 6.2 ABSOLUTE MAXIMUM RATINGS

Parameter	Symbol	Ratings	Unit	Remark	
Supply voltage	V <sub>VI</sub>	-0.3 to +20.0	V	Ta=25°C	
	V <sub>FL</sub>	-0.3 to +20.0	V		
Composite RGB input signal	V <sub>CIN-RGB</sub>	2.0	V <sub>P-P</sub>		
	V <sub>CIN-DC</sub>	-3.5 to +2.5	V		
Analog RGB input signal	V <sub>INAC</sub>	4.0	V <sub>P-P</sub>		
	V <sub>INDC</sub>	-3.0 to +3.0	V		
DC input voltage (SR, SG, SB 240/234, R/L, D/U)	V <sub>IN1</sub>	-0.5 to +5.5	V		
DC input voltage (COLOR, HUE BRIGHT, DIMMER)	V <sub>IN2</sub>	-0.5 to +5.0	V		
Storage temp.	T <sub>ST</sub>	-40 to +95	°C		-
Operating temp.	T <sub>OP</sub>	-30 to +85	°C		Module surface*
Humidity	≤ 95% relative humidity		Ta=40°C	no condensation	
	≤ 85% relative humidity		Ta=50°C		
	Absolute humidity shall not exceed Ta=50°C, 85% relative humidity level.		Ta>50°C		

\* measured at the center of the display area

6.3 ELECTRICAL CHARACTERISTICS

(1) Power supply, logic input

Ta = 25°C

Parameter	Symbol	Min.	Typ.	Max.	Unit	Remark
Supply voltage	V <sub>VI</sub>	8.5	9.5	10.5	V	for PWRVI terminal
	V <sub>FL</sub>	8.5	9.5	10.5	V	for PWRFL terminal
Composite video signal	V <sub>CIN</sub>	-	1.0	-	V	for CIN terminal Zi = 75 Ω
	V <sub>CIN-RGB</sub>	-	0.7	-	V <sub>P-P</sub>	
	V <sub>CIN-DC</sub>	-0.5	-	0.5	V	
Video signal	V <sub>I-RGB</sub>	-	0.7	-	V <sub>P-P</sub>	for RIN, GIN, BIN terminals Zi = 75 Ω
	V <sub>I-DC</sub>	-1.0	-	1.0	V	
Super inpose voltage -ON -OFF	V <sub>IH1</sub>	3.15	-	5.0	V	for SR, SG, SB terminals CMOS-level
	V <sub>IL1</sub>	0	-	0.9	V	
Logic input voltage -Low -High	V <sub>IL2</sub>	0	-	0.9	V	for 240/234, R/L, D/U terminals CMOS-level
	V <sub>IH2</sub>	3.15	-	5.0	V	
Super output voltage -Low -High	V <sub>OL2</sub>	0	-	0.9	V	for VOUT, HOUT terminals CMOS-level
	V <sub>OH2</sub>	3.15	-	5.0	V	
Supply current (@ dot-checkered pattern)	I <sub>VI</sub>	-	200	300	mA	@ V <sub>VI</sub> = 9.5 V
	I <sub>FL</sub>	-	640	800	mA	@ V <sub>FL</sub> = 9.5 V
Luminance control range	LCNT	10	-	100	%	-

6.4 SUPPLY VOLTAGE SEQUENCE

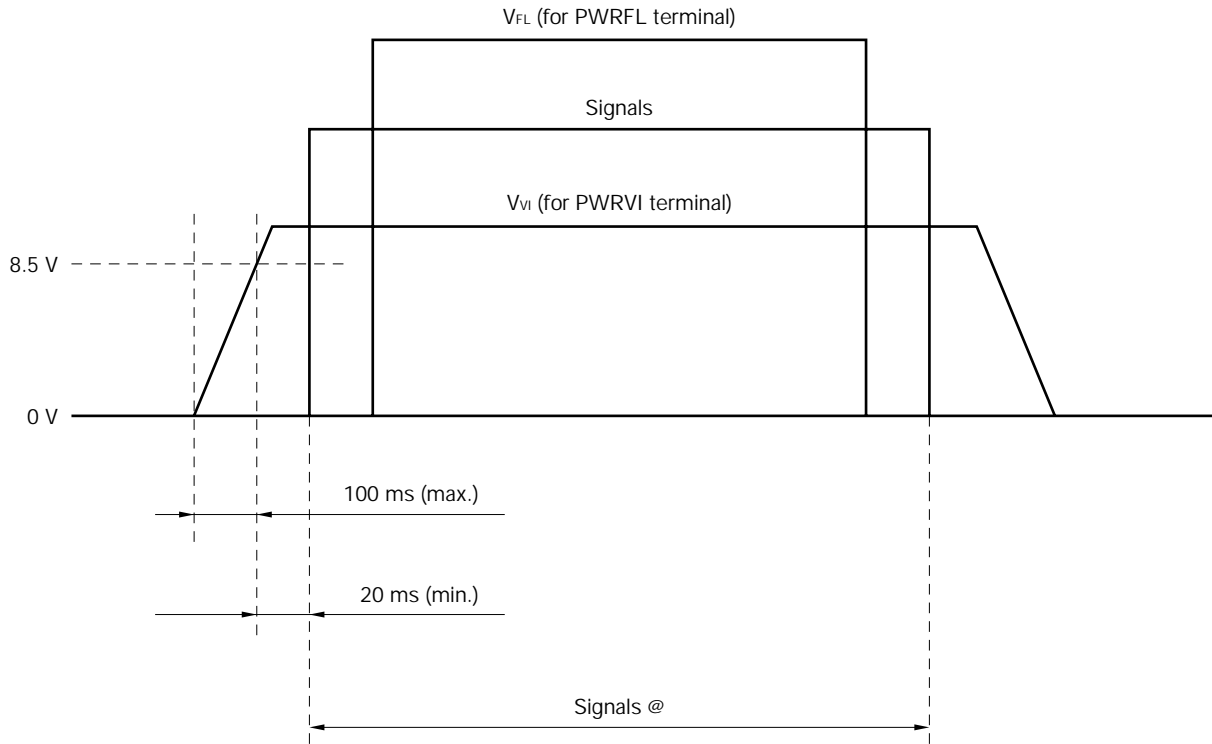

@ CIN, RIN, GIN, BIN, SR, SG, SB, COLOR, HUE, BRIGHT, DIMMER, 240/234, R/L, D/U

- (1) Apply PWRFL within the LCD operation period. When the backlight turns on before LCD operation or the LCD operation turns off, the display may momentarily become white.
  - (2) When the PWRVI is off, please keep whole logic signals low level.
  - (3) Wrong power sequence may damage to the module.
- Attention: As Input  $V_{VI}$ , reach at 8.5 V within 100 ms (max.).

6.5 INTERFACE PIN CONNECTION

(1) Connector 1

Part No. : IL-402-30S-S1L-SA  
 Supplier : Japan Aviation Electronics Industry Limited (JAE)  
 Adaptable card : SUMI-CARD 1.0 mm pitch 30 wick 85°C quality  
 Supplier : SUMITOMO ELECTRIC INDUSTRIES, LTD.

Pin No.	Symbol	Pin No.	Symbol	Pin No.	Symbol
1	DIMMER	11	AGND	21	VOUT
2	PWRFL	12	RIN	22	HOUT
3	PWRFL	13	AGND	23	5 V
4	GNDFL	14	GIN	24	COLOR
5	GNDFL	15	AGND	25	HUE
6	GNDVI	16	BIN	26	BRIGHT
7	GNDVI	17	AGND	27	GND
8	PWRVI	18	YS	28	SR
9	PWRVI	19	N.C.	29	SG
10	CIN	20	N.C.	30	SB

note : N.C. (No Connection) should be open.

(2) Connector 2

Part No. : IL-402-6S-S1L-SA  
 Supplier : Japan Aviation Electronics Industry Limited (JAE)  
 Adaptable card : SUMI-CARD 1.0 mm pitch 6 wick 85°C quality  
 Supplier : SUMITOMO ELECTRIC INDUSTRIES, LTD.

Pin No.	Symbol	Pin No.	Symbol	Pin No.	Symbol
1	GNDVI	3	D/U	5	-
2	R/L	4	240/234	6	GNDVI

## 6.6 PIN DESCRIPTION

## CN1

Pin No.	Symbol	I / O	Logic	Description
10	CIN	Input	Nega.	Composite signal input (1.0 V <sub>P-P</sub> , 75 Ω)
12	RIN	Input	-	Red video signal input (0.7 V <sub>P-P</sub> , 75 Ω)
14	GIN	Input	-	Green video signal input (0.7 V <sub>P-P</sub> , 75 Ω)
16	BIN	Input	-	Blue video signal input (0.7 V <sub>P-P</sub> , 75 Ω)
21	VOUT	Output	Nega.	Horizontal synchronous signal output (CMOS level)
22	HOUT	Output	Nega.	Vertical synchronous signal output (CMOS level)
18	YS	Input	-	Composite / RGB select signal @ H or open : RGB video signal mode L : Composite video signal mode (CMOS level)
28	SR	Input	-	Super impose red signal input (CMOS level) @ H : ON L or open : OFF
29	SG	Input	-	Super impose green signal input (CMOS level) @ H : ON L or open : OFF
30	SB	Input	-	Super impose blue signal input (CMOS level) @ H : ON L or open : OFF
1	DIMMER	Input	-	Dimmer control signal 0.5 V (max.) : bright is off 1.2 V (dark) to 3.5 V (bright)
24	COLOR	Input	-	Color control signal : 0 V (light) to 5.0 V (deep)
25	HUE	Input	-	Hue control signal : 0 V (reddish) to 5.0 V (greenish) @
26	BRIGHT	Input	-	Bright control signal : 0 V (bright) to 5.0 V (dark)
8, 9	PWRVI	Input	-	Power supply for logic 9.5 V±1 V
2, 3	PWRFL	Input	-	Power supply for Backlight 9.5 V±1 V
23	5 V	Output	-	DC power output 5.0 V, 10 mA (max.)
6, 7	GNDVI	-	-	Signal ground for logic
4, 5	GNDFL	-	-	Ground for backlight
11, 13, 15, 17	AGND	-	-	Ground for analog RGB
19, 20	N.C.	-	-	N.C. (No Connection) should be open.

@ Permit to use "open mode".

## CN2

Pin No.	Symbol	I / O	Logic	Description
1	GNDFL	-	-	Ground for backlight
2	R / L	Input	-	Horizontal scanning select signal @ H or open : Right scanning L : Left scanning
3	D / U	Input	-	Vertical scanning select signal @ H or open : Down scanning L : Up scanning
4	240 / 234	Input	-	Vertical display area select signal @ H : 240 lines L or open : 234 lines

@ Permit to use "open mode".



6.7 INPUT SIGNAL TIMING

1. Composite sync mode

(1) 234 line mode

	Parameter	Symbol	Min.	Typ.	Max.	Unit	Remark
CLK	Frequency	1 / tc	-	157.32	-	ns	6.3565 MHz
Vsync	Frequency	tv	15.83 249	16.68 262.5	17.48 275	ms H	59.94 kHz
	Display start	tv <sub>s</sub>	-	1.33 21	-	ms H	
	Display	tv <sub>d</sub>	-	14.87 234	-	ms H	
Hsync	Frequency	th	61.65	63.56 404	65.47	μs CLK	15.734 kHz (typ.)
	Display start	th <sub>s</sub>	-	10.38 66	-	μs CLK	
	Display	th <sub>d</sub>	-	50.34 320	-	μs CLK	
	Pulse-width	th <sub>p</sub>	4.0	4.7	-	μs	
	Back-porch	th <sub>b</sub>	-	4.7	-	μs	

(2) 240 line mode

	Parameter	Symbol	Min.	Typ.	Max.	Unit	Remark
CLK	Frequency	1 / tc	-	157.32	-	ns	6.3565 MHz
Vsync	Frequency	tv	15.83 259	16.68 262.5	17.48 275	ms H	59.94 kHz (typ.)
	Display start	tv <sub>s</sub>	-	1.33 21	-	ms H	
	Display	tv <sub>d</sub>	-	15.25 240	-	ms H	
Hsync	Frequency	th	61.65	63.56 404	65.47	μs CLK	15.734 kHz (typ.)
	Display start	th <sub>s</sub>	-	10.38 66	-	μs CLK	
	Display	th <sub>d</sub>	-	50.34 320	-	μs CLK	
	Pulse-width	th <sub>p</sub>	4.0	4.7	-	μs	
	Back-porch	th <sub>b</sub>	-	4.7	-	μs	

Only operating functions are evaluated for these modes above.

## 2. RGB separate mode

## (1) 234 line mode

	Parameter	Symbol	Min.	Typ.	Max.	Unit	Remark
CLK	Frequency	1 / tc	-	157.32	-	ns	6.3565 MHz
Vsync	Frequency	tv	15.83 249	16.68 262.5	17.48 275	ms H	59.94 kHz (typ.)
	Display start	tv <sub>s</sub>	-	1.33 21	-	ms H	-
	Display	tv <sub>d</sub>	-	14.87 234	-	ms H	-
Hsync	Frequency	th	61.65 -	63.56 404	65.47 -	μs CLK	15.734 kHz (typ.)
	Display start	th <sub>s</sub>	-	11.01 70	-	μs CLK	-
	Display	th <sub>d</sub>	-	50.34 320	-	μs CLK	-
	Pulse-width	th <sub>p</sub>	4.0	4.7	-	μs	-
	Back-porch	th <sub>b</sub>	-	4.7	-	μs	-

Display start period should be pedestal level for analog RGB.

## (2) 240 line mode

	Parameter	Symbol	Min.	Typ.	Max.	Unit	Remark
CLK	Frequency	1 / tc	-	157.32	-	ns	6.3565 MHz
Vsync	Frequency	tv	15.83 249	16.68 262.5	17.48 275	ms H	59.94 kHz (typ.)
	Display start	tv <sub>s</sub>	-	1.33 21	-	ms H	-
	Display	tv <sub>d</sub>	-	15.25 240	-	ms H	-
Hsync	Frequency	th	61.65 -	63.56 404	65.47 -	μs CLK	15.734 kHz (typ.)
	Display start	th <sub>s</sub>	-	11.01 70	-	μs CLK	-
	Display	th <sub>d</sub>	-	50.34 320	-	μs CLK	-
	Pulse-width	th <sub>p</sub>	4.0	4.7	-	μs	-
	Back-porch	th <sub>b</sub>	-	4.7	-	μs	-

Display start period should be pedestal level for analog RGB.

6.8 INPUT SIGNAL TIMMING WAVE (Composite signal)

(1) Vertical direction

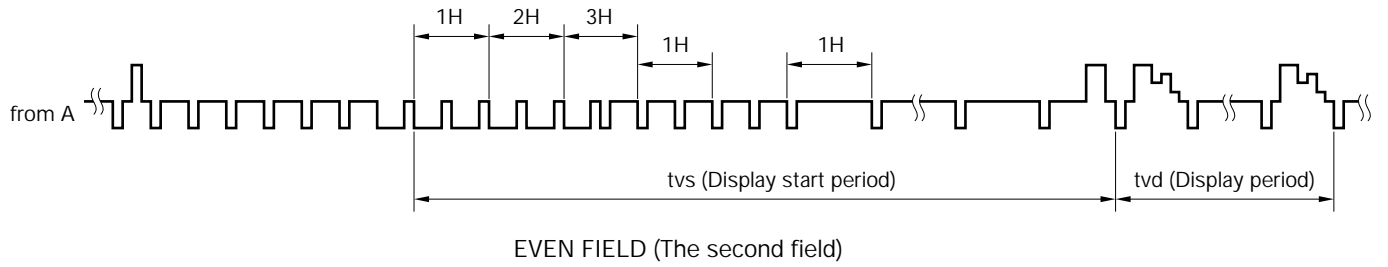
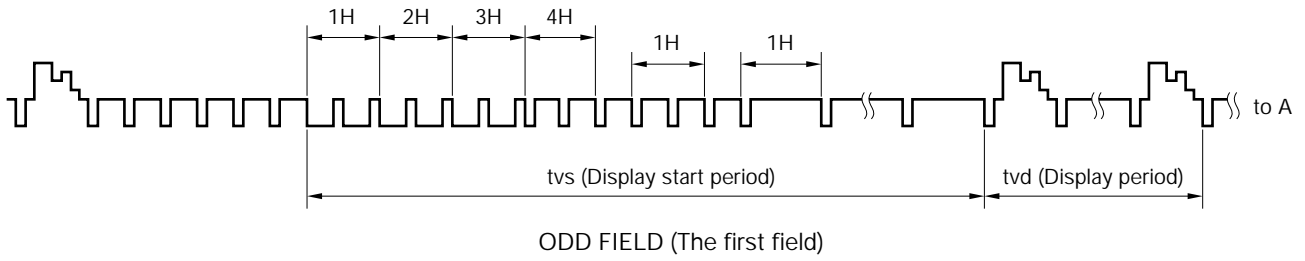

(2) Horizontal direction

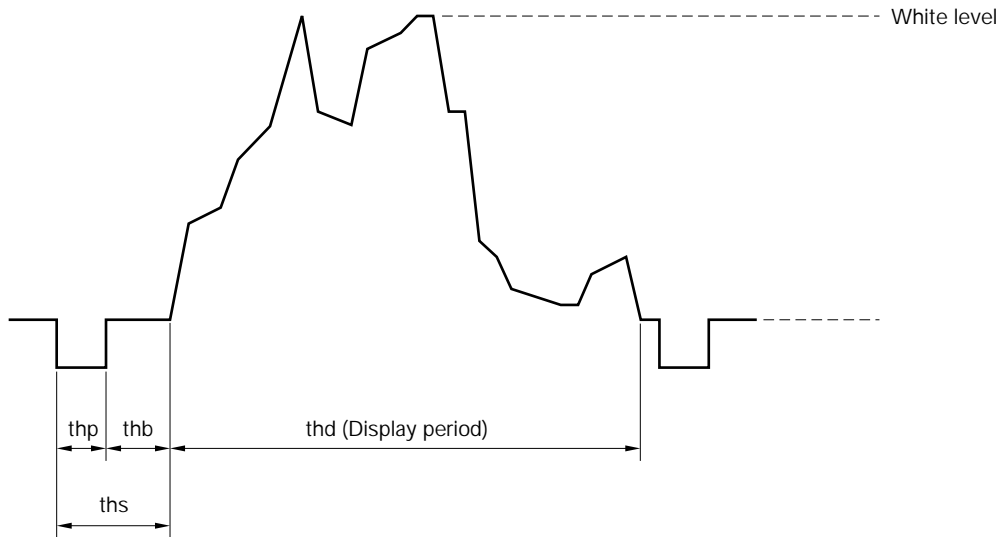

## 7. GENERAL CAUTION

**WARNING**

Do not remove the rear case while the LCD module is operating, because dangerous high voltage is generating.

- (1) Caution when taking out the module
  - ① Pick the pouch only, when taking out module from a shipping package.
- (2) Cautions for handling the module
  - ① As the electrostatic discharges may break the LCD module, handle the LCD module with care. Peel a protection sheet off from the LCD panel surface as slowly as possible.
  - ② As the LCD panel and back-light element are made from fragile glass material, impulse and pressure to the LCD module should be avoided.
  - ③ As the surface of polarizer is very soft and easily scratched, use a soft dry cloth without chemicals for cleaning.
  - ④ Do not pull the interface connectors in or out while the LCD module is operating.
  - ⑤ Put the module display side down on a flat horizontal plane.
  - ⑥ Handle connectors and cables with care.
  - ⑦ The torque to mounting screw should never exceed 0.294 N·m (3.0 kg·cm).
- (3) Cautions for the operation
  - ① When the module is operating, do not lose CLK, HS, or VS signals. If any one of these signals is lost, the LCD panel would be damaged.
  - ② Obey the supply voltage sequence. If wrong sequence is applied, the module would be damaged.
  - ③ Should not intermittently operate the module. It will be the cause of a short life.
- (4) Cautions for the atmosphere
  - ① Dew drop atmosphere should be avoided.
  - ② Do not store and/or operate the LCD module in a high temperature and/or humidity atmosphere. Storage in an electro-conductive polymer packing pouch and under relatively low temperature atmosphere is recommended.
  - ③ Backlight lamp tend to increase the turn on voltage in a cold atmosphere. And the life of module will become short.
- (5) Cautions for the module characteristics
  - ① Do not apply fixed pattern data signal to the LCD module at product aging. Applying fixed pattern for a long time may cause image sticking.
- (6) Other cautions
  - ① Do not disassemble and/or re-assemble LCD module.
  - ② Do not re-adjust variable resistor or switch etc.
  - ③ When returning the module for repair or etc., Please pack the module not to be broken. We recommend to use the original shipping packages.
  - ④ The information in this document is subject to change without notice. Contact your nearest NEC representative for the latest specifications before designing this device into your system.

Liquid Crystal Display has the following specific characteristics. There are not defects or malfunctions. The display condition of LCD module may be affected by the ambient temperature. The LCD module uses cold cathode tubes for backlighting. Optical characteristics, like luminance or uniformity, will change during time. Uneven brightness and/or small spots may be noticed depending on different display patterns.

OUTLINE DRAWING (Unit in mm) Front view

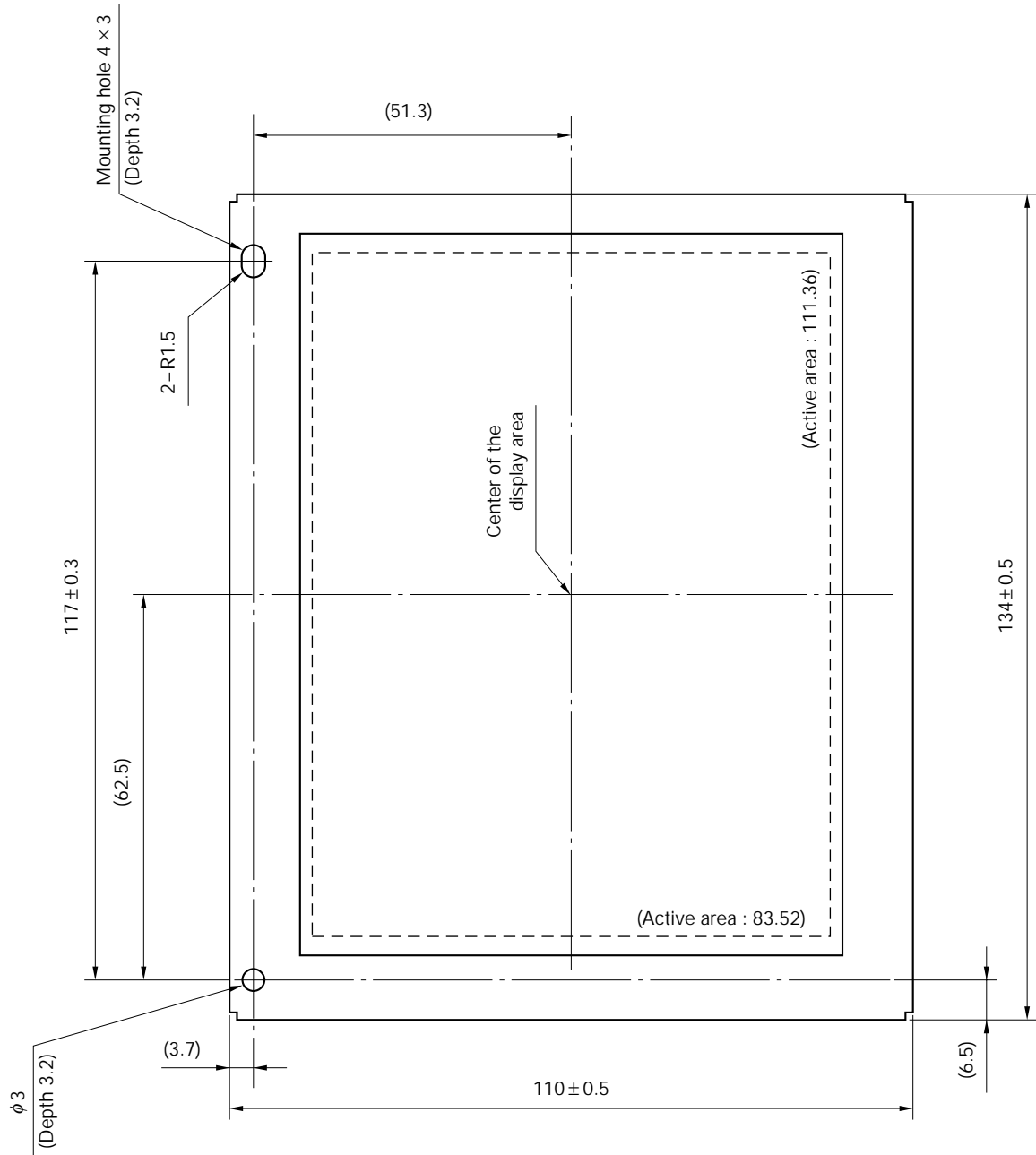

OUTLINE DRAWING (Unit in mm) Rear view

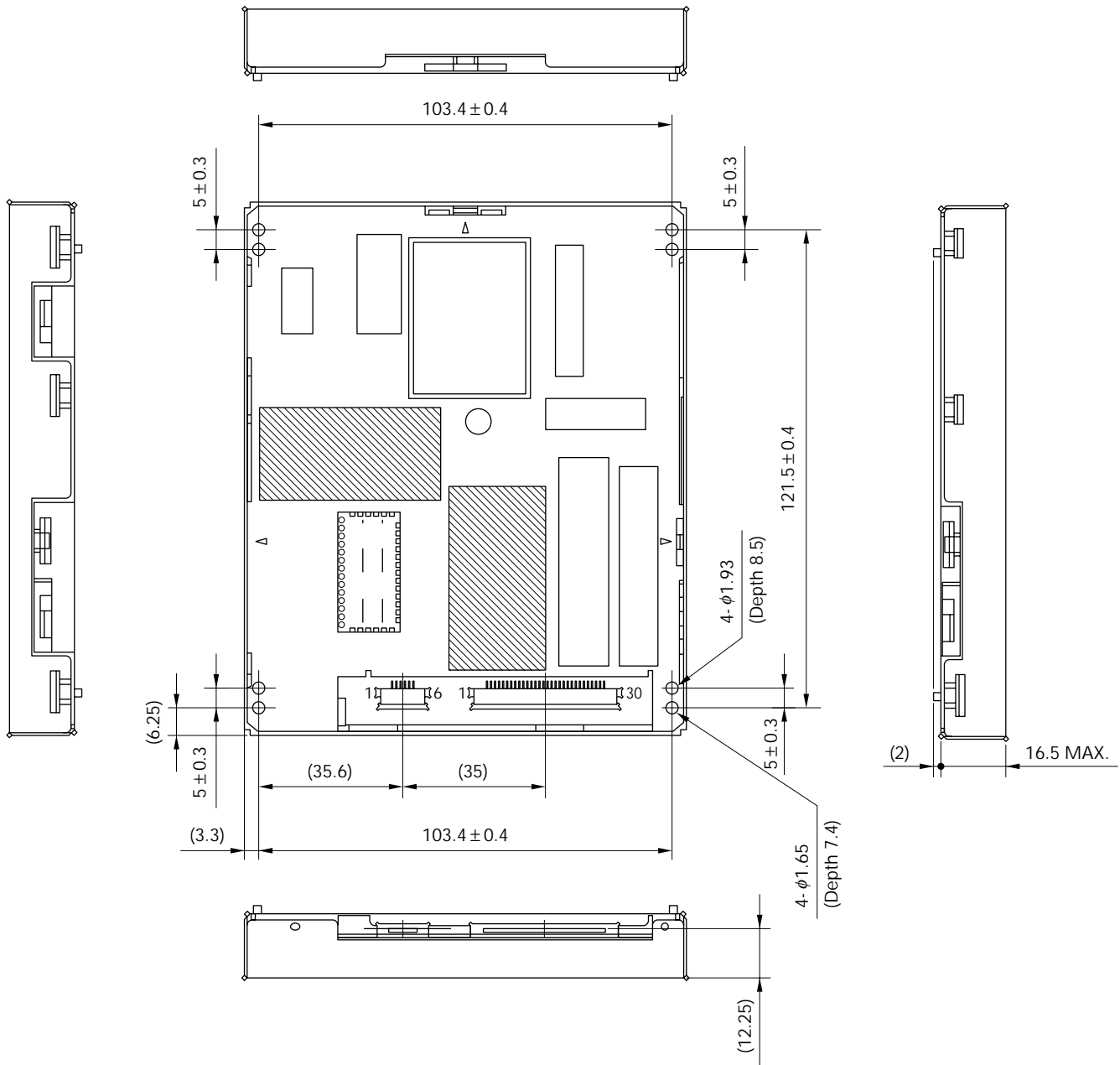



No part of this document may be copied in any form or by any means without the prior written consent of NEC Corporation.

NEC Corporation does not assume any liability for infringement of patents, copyrights or other intellectual property rights of third parties by or arising from use of a device described herein or any other liability arising from use of such device. No license, either express, implied or otherwise, is granted under any patents, copyrights or other intellectual property rights of NEC Corporation or others.