



August 1998

Variable pitch variable loudness 6" Voice ROM

Features

- Single power supply can operate at 2.4 V through 6.0 V.
- Current output can drive 8 ohm speaker with a transistor.
- The voice content can be separated to 32 sections.
- Duration of each section can be different and is multiples of 100 h.
- Duration of sections with appended memory-less mute is up to 21.8 seconds (20000h).
- 3 straight trigger pins are provided TGA, TGB, TGC. Each cross can access a sentence.
- 3 x 3 matrix trigger crosses are provided by RW1-4, K1-4. Each cross can access a sentence.
- Each sentence is composed of one or more sections.
- Lower key priority is provided for straight inputs and matrix cross inputs.
- Last key priority is provided for straight inputs.
- First key priority is provided for 4x4 crosses.
- Up to 512 table entries for all 32 sentences.
- Auto ramp up / ramp down & sleep functions are built in.
- INT(interrupt) function is provided.
- OKY function is provided optionally chipwise.
- Play all OKY is provided optionally chipwise.
- Random Play OKY is provided optionally chipwise.
- Playnext OKY is provided optionally chipwise.
- Continuous S.W.A.I. OKY is provided optionally chipwise.
- Home S.W.A.I. OKY is provided optionally chipwise.
- 5 output pins are provided.
- 20 ms debounce is provided.
- Sink LED is provided.
- Off LED when Playing audio is provided optionally entrywise.
- Slow Ring flash LED when playing audio is provided optionally entrywise.
- Dynamic flash LED when playing audio is provided optionally entrywise.
- Slow fix flash LED when playing audio is provided optionally entrywise.
- On LED when playing audio is provided optionally entrywise.
- High busy when playing audio is provided optionally entrywise.
- Low busy when playing audio is provided optionally entrywise.
- DC high (when playing audio and lasts to next trigger) is provided optionally entrywise.
- DC low(when playing audio and lasts to next trigger) is provided optionally entrywise.
- Low Stop after playing audio is provided optionally entrywise.
- High Stop after playing audio is provided optionally entrywise.
- OKY's sentences could be different from those from TGS'.
- 8 loudness levels are provided entrywise.
- 8 different pitches are provided entrywise.
- Edge trigger is provided optionally triggerwise.
- Level trigger is provided optionally triggerwise.
- Holdable output by TG is provided optionally triggerwise.
- Retriggerable TG by itself is provided optionally triggerwise.
- Retriggerable TG by others is provided optionally triggerwise.
- High trigger is provided optionally triggerwise.
- Low trigger is provided optionally triggerwise.

Block Diagram

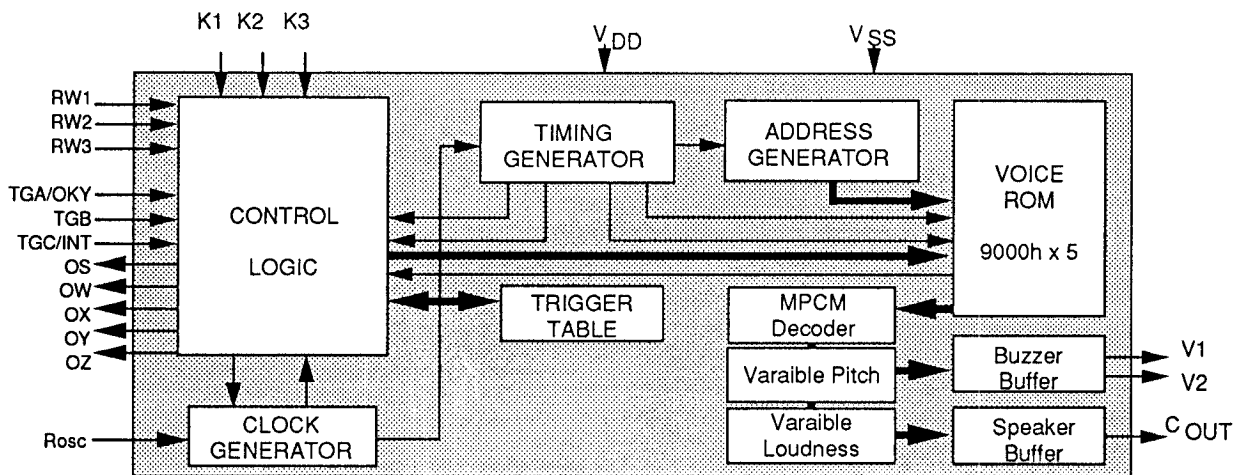

Specifications subject to change without notice, contact your sales representatives for the most recent information.