

# Agilent MSA-2743 Cascadable Silicon Bipolar Gain Block MMIC Amplifier Data Sheet

## Description

Agilent Technologies' MSA-2743 is a low current silicon gain block MMIC amplifier housed in a 4-lead SC-70 (SOT-343) surface mount plastic package.

Providing a nominal 15.5 dB gain at up to 15 dBm Pout, this device is ideal for small-signal gain stages or IF amplification.

The Darlington feedback structure provides inherent broad bandwidth performance. The 25 GHz  $f_t$  fabrication process results in a device with low current draw and useful operation to past 3 GHz.

## Typical Biasing Configuration

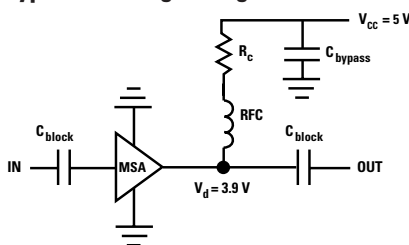

## Features

- Small signal gain amplifier
- Low current draw
- Wide bandwidth
- 50 Ohms input & output
- Low cost surface mount small plastic package SOT-343 (4 lead SC-70)
- Tape-and-reel packaging option available

## Specifications

2 GHz; 5V, 50 mA (typ.)

- 15.5 dB associated gain
- 15 dBm P1dB
- 4 dB noise figure
- 28 dBm output IP3
- Useful gain past 3 GHz

## Applications

- Cellular/PCS/WLL basestations
- Wireless data/WLAN
- Fiber-optic systems
- ISM
- General purpose gain block amplifier

## Surface Mount Package SOT-343/4-lead SC70

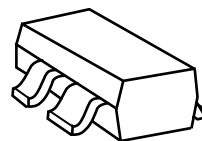

## Pin Connections and Package Marking

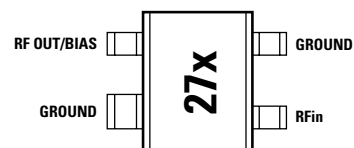

**Note:**  
Top View. Package marking provides orientation and identification. 'x' is a character to identify date code.



**Agilent Technologies**

Innovating the HP Way

### MSA-2743 Absolute Maximum Ratings<sup>[1]</sup>

Symbol	Parameter	Units	Absolute Maximum
$I_d$	Device Current	mA	80
$P_{diss}$	Total Power Dissipation <sup>[2]</sup>	mW	330
$P_{in\ max.}$	RF Input Power	dBm	20
$T_{Jmax}$	Junction Temperature	°C	150
$T_{STG}$	Storage Temperature	°C	-65 to 150
$\theta_{jc}$	Thermal Resistance <sup>[3]</sup>	°C/W	115

**Notes:**

1. Operation of this device above any one of these parameters may cause permanent damage.
2. Ground lead temperature is 25°C. Derate 8.7 mW/°C for  $T_L > 112^\circ\text{C}$ .
3. Thermal resistance measured using 150°C Liquid Crystal Measurement method.

### Electrical Specifications

$T_A = +25^\circ\text{C}$ ,  $I_d = 50\ \text{mA}$ ,  $Z_0 = 50\ \Omega$ , RF parameters measured in a test circuit for a typical device

Symbol	Parameter and Test Condition	Frequency	Units	Min.	Typ. <sup>[1]</sup>	Max.	$\sigma$
$V_d$	Device Voltage, $I_d = 50\ \text{mA}$		V	3.5	3.9	4.3	0.04
$G_P$	Power Gain (IS21I <sup>2</sup> )	900 MHz 2 GHz	dB	14	16 15.5	17	0.18 0.17
$\Delta G_P$	Gain Flatness	0.1 to 2 GHz	dB		$\pm 0.29$		
$F_{3dB}$	3 dB Bandwidth		GHz		6.2		
$VSWR_{in}$	Input Voltage Standing Wave Ratio	0.1 to 6 GHz			1.4:1		
$VSWR_{out}$	Output Voltage Standing Wave Ratio	0.1 to 6 GHz			1.2:1		
NF	50Ω Noise Figure	900 MHz 2 GHz	dB		3.9 4.1		0.19 0.16
$P_{1dB}$	Output Power at 1 dB Gain Compression	900 MHz 2 GHz	dBm		16.1 15		0.05 0.08
$OIP_3$	Output Third Order Intercept Point	900 MHz 2 GHz	dBm		31 28		0.08 0.17
DV/dT	Device Voltage Temperature Coefficient		mV/°C		-4.4		

**Notes:**

1. Typical value determined from a sample size of 500 parts from 6 wafers.
2. Standard deviation is based on 500 samples taken from 6 different wafers. Future wafers allocated to this product may have typical values anywhere between the minimum and maximum specification limits.

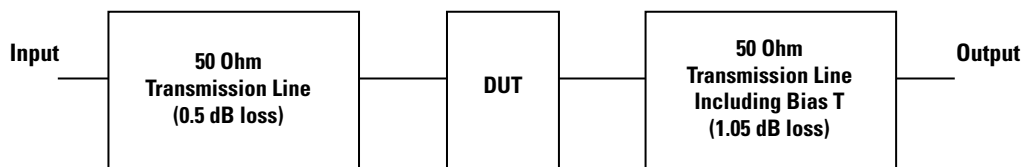

Block diagram of 2 GHz production test board used for gain measurements. Circuit losses have been de-embedded from actual measurements.

### MSA-2743 Typical Performance

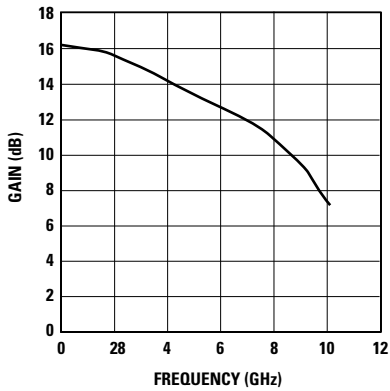

Figure 1. Gain vs. Frequency at  $I_d = 50$  mA.

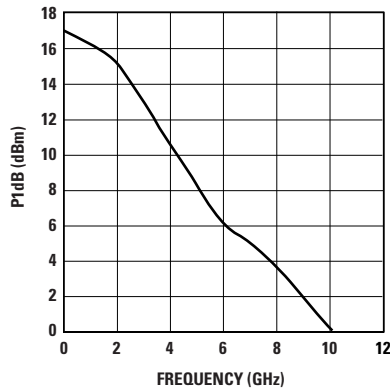

Figure 2. P1dB vs. Frequency at  $I_d = 50$  mA.

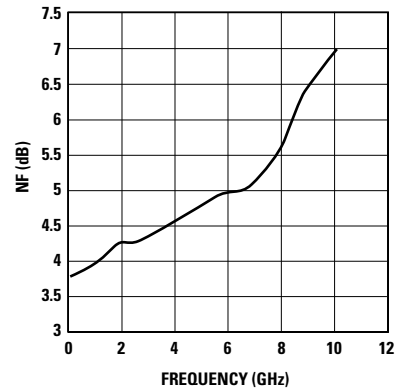

Figure 3. NF vs. Frequency at  $I_d = 50$  mA.

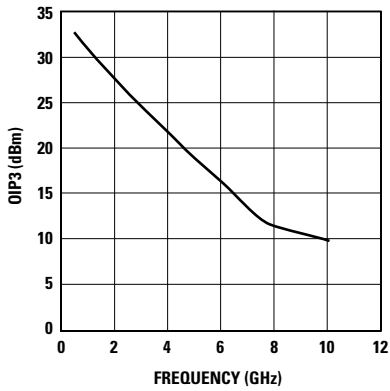

Figure 4. OIP3 vs. Frequency at  $I_d = 50$  mA.

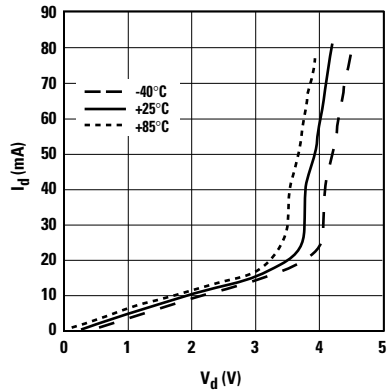

Figure 5.  $I_d$  vs.  $V_d$  and Temperature.

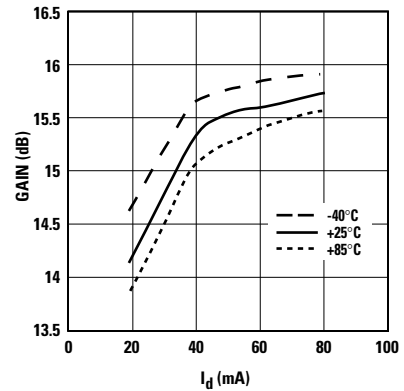

Figure 6. Gain vs.  $I_d$  and Temperature at 2 GHz.

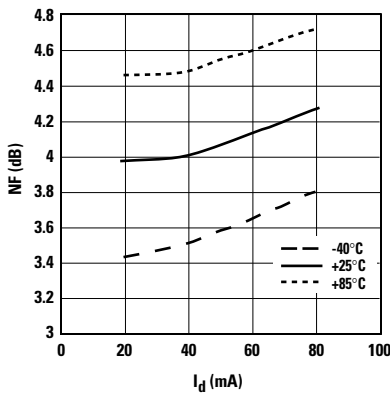

Figure 7. NF vs.  $I_d$  and Temperature at 2 GHz.

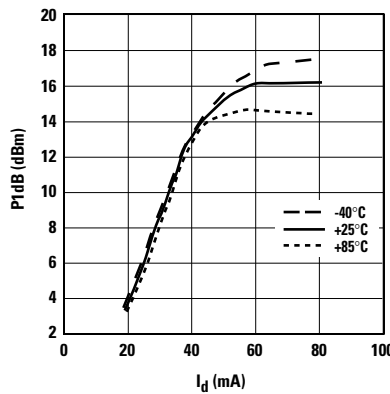

Figure 8. P1dB vs.  $I_d$  and Temperature at 2 GHz.

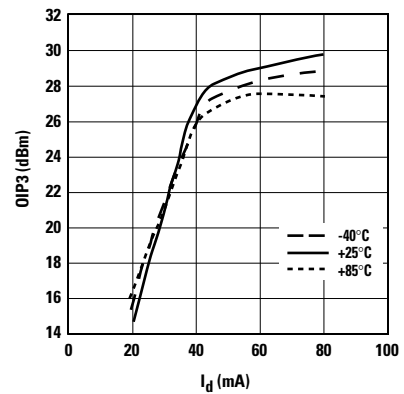
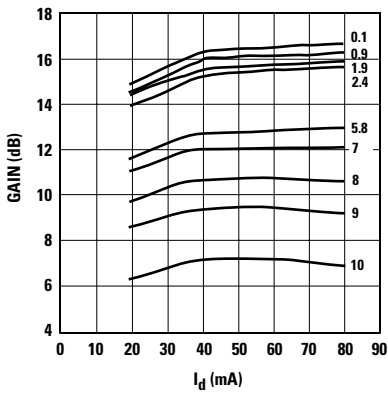
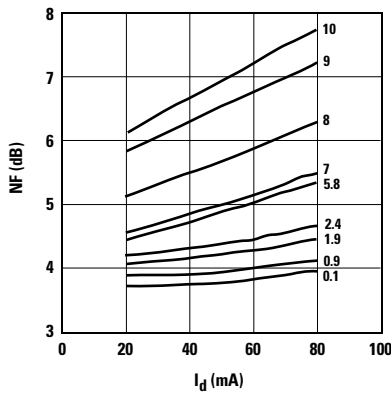

Figure 9. OIP3 vs.  $I_d$  and Temperature at 2 GHz.

**MSA-2743 Typical Performance, continued**



**Figure 10. Gain vs.  $I_d$  and Frequency (GHz).**



**Figure 11. NF vs.  $I_d$  and Frequency (GHz).**

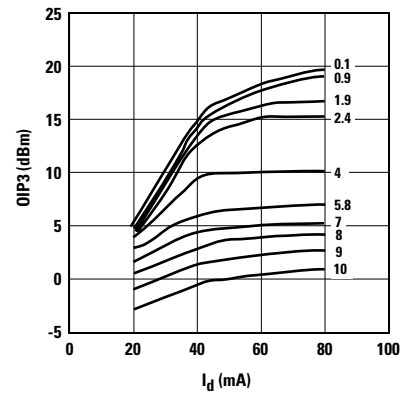

**Figure 12. P1dB vs.  $I_d$  and Frequency (GHz).**

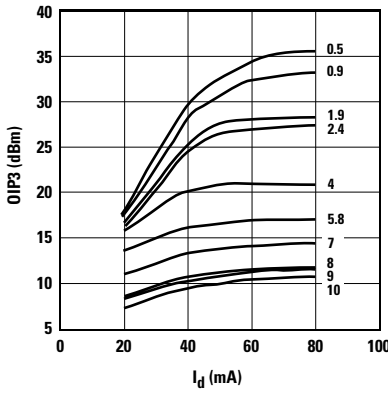

**Figure 13. OIP3 vs.  $I_d$  and Frequency (GHz).**

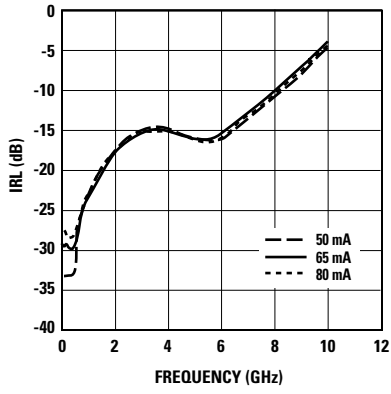

**Figure 14. Input Return Loss vs.  $I_d$  and Frequency.**

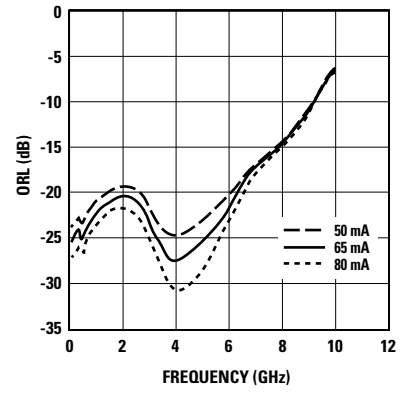

**Figure 15. Output Return Loss vs.  $I_d$  and Frequency.**

### MSA-2743 Typical Scattering Parameters

$T_A = 25^\circ\text{C}$ ,  $I_d = 50\text{ mA}$

Freq (GHz)	S <sub>11</sub> (Mag)	S <sub>11</sub> (Ang)	S <sub>21</sub> (dB)	S <sub>21</sub> (Mag)	S <sub>21</sub> (Ang)	S <sub>12</sub> (Mag)	S <sub>12</sub> (Ang)	S <sub>22</sub> (Mag)	S <sub>22</sub> (Ang)	K
0.1	0.022	158	16.15	6.423	176.8	0.104	-0.8	0.065	-5.4	1.1
0.5	0.042	102.4	16.11	6.387	164.3	0.103	-4.1	0.068	-26.7	1.1
0.9	0.061	57.9	16.01	6.319	151.9	0.1	-6.5	0.085	-52.7	1.1
1.0	0.068	51.3	15.98	6.296	148.8	0.1	-7.1	0.089	-57.3	1.1
1.5	0.1	26.5	15.8	6.169	133.6	0.097	-9.2	0.103	-73.1	1.1
1.9	0.124	11.6	15.63	6.044	121.7	0.095	-10.5	0.109	-82.9	1.1
2.0	0.13	8.2	15.58	6.01	118.7	0.095	-10.8	0.109	-85.1	1.2
2.5	0.155	-6.4	15.33	5.842	104.1	0.093	-12.2	0.103	-99.9	1.2
3.0	0.172	-17.7	15.04	5.652	89.8	0.092	-13.5	0.083	-117.6	1.2
3.5	0.179	-28.2	14.75	5.461	75.9	0.091	-14.6	0.064	-137	1.2
4.0	0.17	-41.3	14.47	5.29	62.2	0.091	-15.8	0.058	-165.5	1.2
4.5	0.164	-57.6	14.2	5.13	48.4	0.091	-16.7	0.064	166.8	1.3
5.0	0.155	-76.6	13.9	4.955	34.6	0.091	-17.6	0.07	153.9	1.3
5.5	0.147	-100.9	13.59	4.783	21.1	0.091	-17.8	0.084	152.6	1.3
6.0	0.155	-129.7	13.28	4.613	7.4	0.094	-17.5	0.095	149.9	1.3
6.5	0.185	-155.9	12.9	4.415	-6.5	0.097	-17.5	0.118	150.2	1.3
7.0	0.213	-177.8	12.5	4.215	-20.1	0.104	-17.3	0.147	144.2	1.3
7.5	0.242	160	12.02	3.991	-33.8	0.112	-18.8	0.167	132.9	1.2
8.0	0.276	139.1	11.52	3.765	-47.4	0.121	-20.4	0.189	120.1	1.2
8.5	0.328	120.4	11.04	3.563	-60.8	0.136	-21.5	0.231	109.2	1.1
9.0	0.401	101.3	10.52	3.357	-74.7	0.157	-25.9	0.295	95	0.9
9.5	0.496	82.5	9.93	3.139	-89.5	0.18	-33.6	0.385	80.5	0.8
10.0	0.583	65	9.04	2.832	-104.5	0.197	-43.2	0.477	65.2	0.7

**Notes:**

1. S-parameters are measured on a microstrip line made on 0.025 inch thick alumina carrier. The input reference plane is at the end of the input lead. The output reference plane is at the end of the output lead. The parameters include the effect of four plated through via holes connecting ground landing pads on top of the test carrier to the microstrip ground plane on the bottom side of the carrier. Two 0.020 inch diameter via holes are placed within 0.010 inch from each ground lead contact point, one via on each side of that point.

### MSA-2743 Typical Scattering Parameters

$T_A = 25^\circ\text{C}$ ,  $I_d = 65\text{ mA}$

Freq (GHz)	S <sub>11</sub> Mag	S <sub>11</sub> Ang	S <sub>21</sub> (dB)	S <sub>21</sub> (Mag)	S <sub>21</sub> (Ang)	S <sub>12</sub> (Mag)	S <sub>12</sub> (Ang)	S <sub>22</sub> (Mag)	S <sub>22</sub> (Ang)	K
0.1	0.034	165.2	16.32	6.546	176.8	0.103	-0.7	0.05	-5.7	1.1
0.5	0.049	115.3	16.27	6.511	164.2	0.101	-3.9	0.054	-28.3	1.1
0.9	0.061	69.2	16.18	6.442	151.7	0.099	-6.2	0.072	-55.9	1.1
1.0	0.067	61.4	16.15	6.42	148.6	0.098	-6.7	0.075	-60.5	1.1
1.5	0.097	32.8	15.97	6.29	133.3	0.096	-8.7	0.089	-75.2	1.1
1.9	0.12	16.2	15.79	6.162	121.3	0.095	-10.1	0.094	-83.9	1.1
2.0	0.126	12.4	15.75	6.128	118.3	0.094	-10.4	0.095	-85.9	1.1
2.5	0.151	-3.5	15.5	5.955	103.6	0.093	-11.8	0.088	-100	1.2
3.0	0.17	-15.7	15.21	5.758	89.1	0.092	-13.1	0.068	-117.3	1.2
3.5	0.177	-26.9	14.9	5.559	75.1	0.091	-14.3	0.049	-136.7	1.2
4.0	0.167	-40.7	14.62	5.382	61.3	0.091	-15.6	0.042	-168.5	1.2
4.5	0.161	-57.8	14.35	5.215	47.4	0.091	-16.6	0.049	161.1	1.3
5.0	0.152	-78	14.04	5.034	33.5	0.091	-17.5	0.054	150.3	1.3
5.5	0.145	-103.3	13.72	4.854	19.9	0.091	-17.7	0.067	154.3	1.3
6.0	0.156	-133.3	13.4	4.675	6.1	0.093	-17.2	0.08	154.4	1.3
6.5	0.188	-159.4	13	4.467	-7.9	0.097	-17.1	0.106	156	1.3
7.0	0.218	178.6	12.58	4.255	-21.7	0.103	-16.6	0.138	149.6	1.3
7.5	0.25	156.6	12.08	4.02	-35.5	0.112	-18	0.16	137.6	1.2
8.0	0.285	135.9	11.56	3.784	-49.1	0.121	-19.6	0.184	124.3	1.2
8.5	0.341	117.4	11.05	3.57	-62.6	0.137	-20.8	0.228	112.5	1
9.0	0.414	98.7	10.51	3.353	-76.5	0.158	-25.4	0.293	97.3	0.9
9.5	0.51	80.1	9.89	3.122	-91.4	0.182	-33.3	0.384	82	0.8
10.0	0.596	63	8.97	2.808	-106.3	0.199	-43	0.476	66.2	0.7

**Notes:**

1. S-parameters are measured on a microstrip line made on 0.025 inch thick alumina carrier. The input reference plane is at the end of the input lead. The output reference plane is at the end of the output lead. The parameters include the effect of four plated through via holes connecting ground landing pads on top of the test carrier to the microstrip ground plane on the bottom side of the carrier. Two 0.020 inch diameter via holes are placed within 0.010 inch from each ground lead contact point, one via on each side of that point.

**MSA-2743 ADS Model**

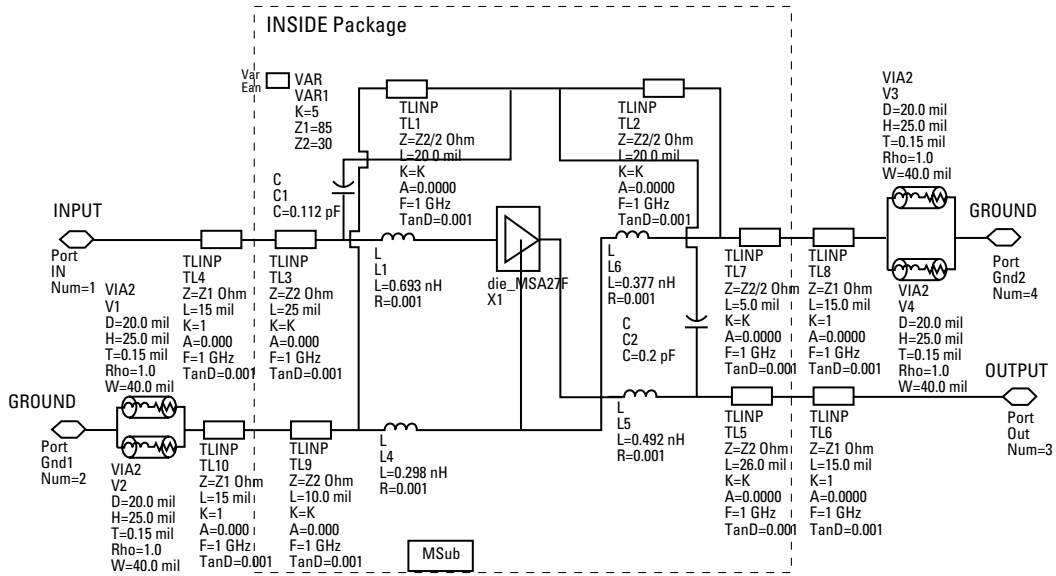

Note:  
Vias are not part of the package. They are only added during simulation to account for the vias in the test fixture.

MSUB  
MSUB1  
H=25.0 mil  
Er=9.6  
Mur=1  
Cond=1.0E+50  
Hu=3.9e+034 mil  
T=0.15 mil  
TanD=0  
Rough=0 mil

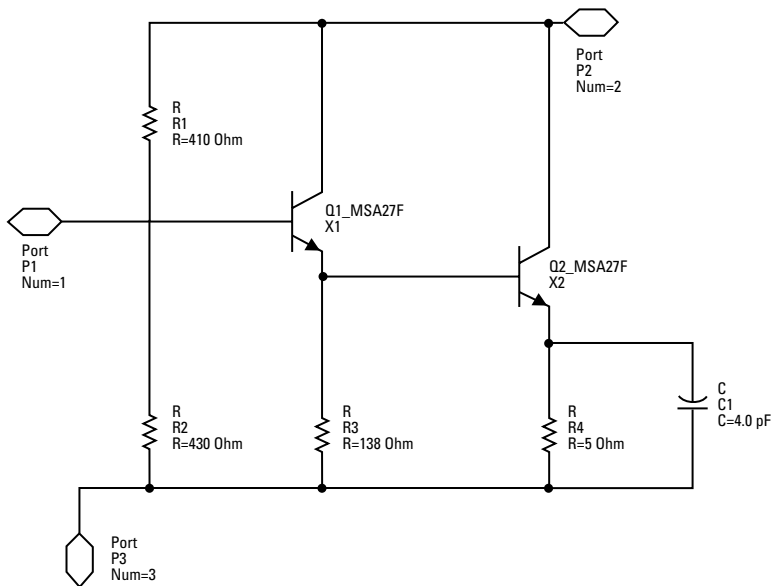

## Q1 MSA-27 Transistor Model

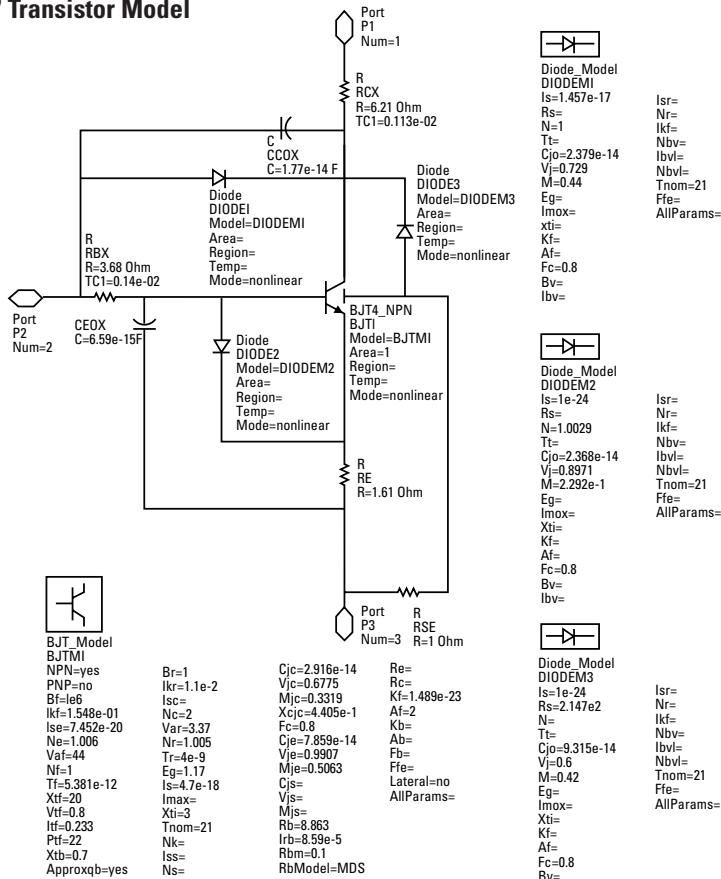

## Q2 MSA-27 Transistor Model

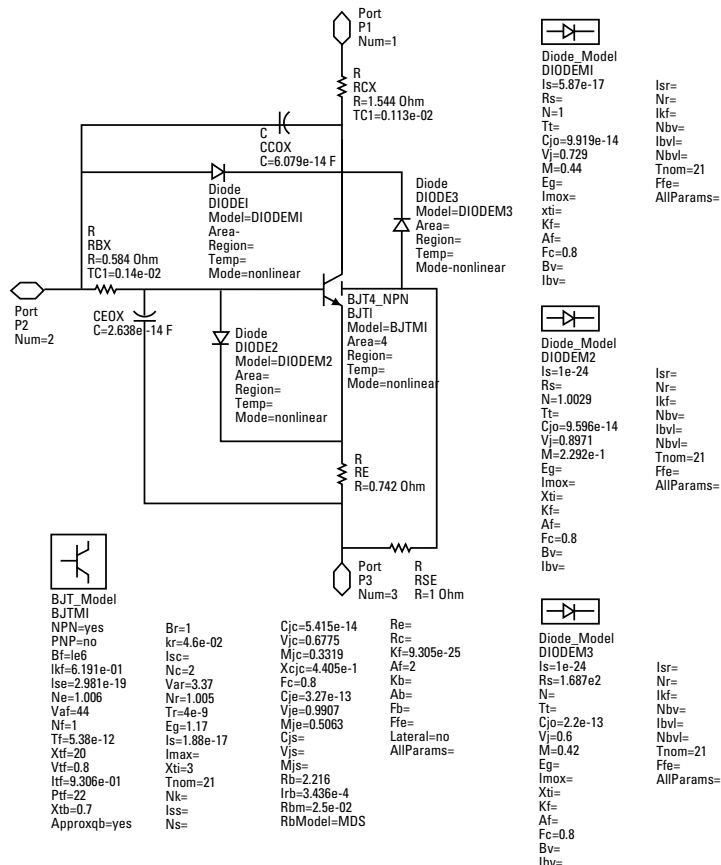



## MSA-2743 RFIC Amplifier Description

Agilent Technologies' MSA-2743 is a low current silicon gain block RFIC amplifier housed in a 4-lead SC-70 (SOT-343) surface mount plastic package. Providing a nominal 15.5 dB gain at up to +18.5 dBm Pout, this device is ideal for small-signal gain stages or IF amplification. The Darlington feedback structure provides inherent broad bandwidth performance. The 25 GHz  $f_t$  fabrication process results in a device with low current draw and useful operation above 3 GHz.

A feature of the MSA-2743 is its broad bandwidth that is useful in many satellite-based TV, cable TV and datacom systems.

In addition to use in buffer and driver amplifier applications in the TV market, the MSA-2743 will find many applications in wireless communication systems.

### Application Guidelines

The MSA-2743 is very easy to use. For most applications, all that is required to operate the MSA-2743 is to apply 50 mA to 70 mA to the RF Output pin.

### RF Input and Output

The RF Input and Output ports of the MSA-2743 are closely matched to 50Ω.

### DC Bias

The MSA-2743 is a current-biased device that operates from a 50 mA to 70 mA current source. Curves of typical performance as a function of bias current are shown in section one of the data sheet. Figure 1 shows a typical implementation of the MSA-2743. The supply current for the MSA-2743 must be applied to the RF Output

pin. The power supply connection to the RF Output pin is achieved by means of a RF choke (inductor). The value of the RF choke must be large relative to 50Ω in order to prevent loading of the RF Output. The supply voltage end of  $R_c$  is bypassed to ground with a capacitor. Blocking capacitors are normally placed in series with the RF Input and the RF Output to isolate the DC voltages on these pins from circuits adjacent to the amplifier. The values for the blocking and bypass capacitors are selected to provide a reactance at the lowest frequency of operation that is small relative to 50Ω.

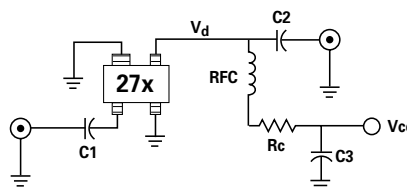

Figure 1. Schematic Diagram with Bias Connections.

### PCB Layout

A recommended PCB pad layout for the miniature SOT-343 (SC-70) package that is used by the MSA-2743 is shown in Figure 2.

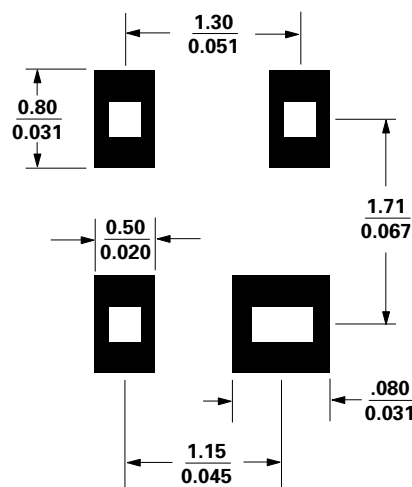

Figure 2. PCB Pad Layout for MSA-2743. Package dimensions in mm/inches.

This layout provides ample allowance for package placement by automated assembly equipment without adding parasitics that could impair the high frequency RF performance of the MSA-2743. The layout is shown with a footprint of a SOT-343 package superimposed on the PCB pads for reference.

Starting with the package pad layout in Figure 3, an RF layout similar to the one shown in Figure 3 is a good starting point for microstripline designs using the MSA-2743 amplifier.

### PCB Materials

FR-4 or G-10 type materials are good choices for most low cost wireless applications using single or multi-layer printed circuit boards. Typical single-layer board thickness is 0.020 to 0.031 inches. Circuit boards thicker than 0.031 inches are not recommended due to excessive inductance in the ground vias. This is discussed in more detail in the section on RF grounding.

### Applications Example

The printed circuit layout in Figure 3 is a multi-purpose layout that will accommodate components for using the MSA-2743 for RF inputs from DC through 3 GHz. This layout is a microstripline design (solid groundplane on the backside of the circuit board) with 50Ω interfaces for the RF input and output. The circuit is fabricated on 0.031-inch thick FR-4 dielectric material. Plated through holes (vias) are used to bring the ground to the top side of the circuit where needed. Multiple vias are used to reduce the inductance of the paths to ground.

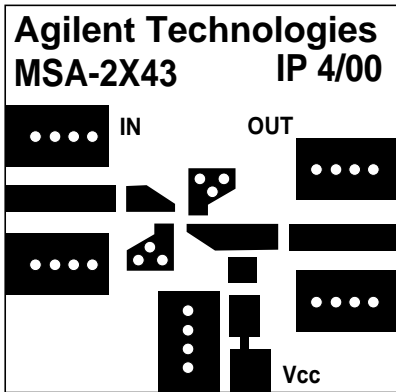

Figure 3. Multi-purpose Evaluation Board.

The amplifier and related components are assembled onto the printed circuit board as shown in Figure 6. The MSA-2X43 circuit board is designed to use edge-mounting SMA connectors such as Johnson Components, Inc., Model 142-0701-881. These connectors are designed to slip over the edge of 0.031-inch thick circuit boards and obviate the need to mount PCBs on a metal base plate for testing. The center conductors of the connectors are soldered to the input and output microstrip lines. The ground pins are soldered to the ground plane on the back of the board and to the top ground pads.

DC blocking capacitors are required at the input and output of the IC. The values of the blocking capacitors are determined by the lowest frequency of operation for a particular application. The capacitor's reactance is chosen to be 10% or less of the amplifier's input or output impedance at the lowest operating frequency. For example, an amplifier to be used in an application covering the 900 MHz band would require an input blocking capacitor of at least 39 pF, which is 4.5Ω of reactance at 900 MHz. The Vcc connection to the amplifier must be RF bypassed by placing a capacitor to ground at the bias pad of the board. Like the DC blocking capacitors, the value

of the Vcc bypass capacitor is determined by the lowest operating frequency for the amplifier. Space is available on the circuit board to add a bias choke, bypass capacitors, and collector resistors. The MSA series of ICs requires a bias resistor to ensure thermal stability. The bias resistor value is calculated from the operating current value, device voltage and the supply voltage; see equation below. When applying bias to the board, start at a low voltage level and slowly increase the voltage until the recommended current is reached. Both power and gain can be adjusted by varying  $I_d$ .

$$R_c = \frac{V_{cc} - V_d}{I_d} \Omega$$

Where:

- Vcc = The power supply voltage applied to Rc (volts)
- V<sub>d</sub> = The device voltage (volts)
- I<sub>d</sub> = The quiescent bias current drawn by the device

#### Notes on Rc Selection

The value of Rc is dependant on V<sub>d</sub>, any production variation in V<sub>d</sub> will have an effect on I<sub>d</sub>. As the gain and power performance of the MSA-2743 may be adjusted by varying I<sub>d</sub> this will have to be

taken into account. The characterization data in section one shows the relationship between V<sub>d</sub> and I<sub>d</sub> over temperature. At lower temperatures the value of V<sub>d</sub> increases. The increase in V<sub>d</sub> at low temperatures and production variations may cause potential problems for the amplifier performance if it is not taken into account. One solution would be to increase the voltage supply to have at least a 4V drop across the bias resistor Rc. This will guarantee good temperature stability. Table 1 shows the effects of Rc on the performance of the MSA-2743 over temperature.

An alternative solution to ensure good temperature stability without having a large voltage drop across a resistor would be to use an active bias circuit as shown in Figure 4. The resistors R1 and the PNP transistor connected to form a diode by connecting the base and collector together and R2 form a potential divider circuit to set the base voltage of the bias PNP transistor. The diode connected PNP transistor is used to compensate for the voltage variation of the base-emitter junction with temperature of the bias PNP transistor. R3 provides a bleed path for any excess bias; it

Table 1. Effects of Rc on Performance over Temperature. Device voltage = 3.9V nominally at 25°C.

Voltage Drop, volts	Resistor Value, Ohms	Temperature, °C	Bias Current, mA	Power Gain @ 2.0 GHz, dB
0	0	0	41.8	15.2
		25	50.0	15.1
		85	66.8	15.0
1.35	27	0	47.3	15.3
		25	50.0	15.1
		85	56.5	14.9
2.35	47	0	47.8	15.2
		25	50.0	15.1
		85	53.5	14.8
6.0	120	0	49.1	15.3
		25	50.0	15.1
		85	51.8	14.9

is a safety feature and can be omitted from the circuit, a typical value for R3 is 1KΩ. Rc is a feedback element that keeps Id constant. The value of Rc is approximated by assuming a 0.5V drop across it; see equation below. For 50 mA Id, 5Volt Vcc bias, a typical value for R1 is 560Ω and R2 is 110Ω. A CAD program such as Agilent Technologies ADS® is recommended to determine the values of R1 and R2 at other bias levels. The value of the RF choke should be large compared to 50Ω, typical value for a 1.9 GHz amplifier would be 22 nH. The DC blocking capacitors are calculated as described above. A typical value for C3 would be 1.0 uF.

$$R_c = \frac{0.5}{I_d} \Omega$$

The active bias solution will only require about a 1.3V difference between Vcc and Vd for good bias stability over temperature. For more details on the active bias circuit please refer to application note AN-A003 Biasing MODAMP MMICs.

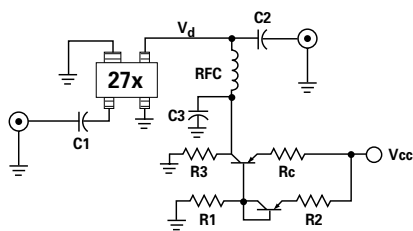

Figure 4. Active Bias Circuit.

### 1.9 GHz Design

To illustrate the simplicity of using the MSA-2743, a 1.9 GHz amplifier for PCS type applications is presented. The amplifier uses a 5.25V, 50 mA supply. The input and

output of the MSA-2743 is already well matched to 50Ω and no additional matching is needed.

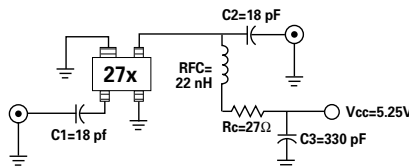

Figure 5. Schematic of 1.9 GHz Circuit.

A schematic diagram of the complete 1.9 GHz circuit with DC biasing is shown in Figure 5. DC bias is applied to the MSA-2743 through the RFC at the RF Output pin. The power supply connection is bypassed to ground with capacitor C3. Provision is made for an additional bypass capacitor, C4, to be added to the bias line near the +5 volt connection. C4 will not normally be needed unless several stages are cascaded using a common power supply.

The input terminal of the MSA-2743 is not at ground potential, an input DC blocking capacitor is needed.

The values of the DC blocking and RF bypass capacitors should be chosen to provide a small reactance (typically < 5 ohms) at the lowest operating frequency. For this 1.9 GHz design example, 18 pF capacitors with a reactance of 4.5 ohms are adequate. The reactance of the RF choke (RFC) should be high (i.e., several hundred ohms) at the lowest frequency of operation. A 22 nH inductor with a reactance of 262 ohms at 1.9 GHz is sufficiently high to minimize the loss from circuit loading.

Table 2. Component Parts List for the MSA-2743 Amplifier at 1.9 GHz.

R1	27Ω chip resistor
RFC	22 nH LL1608-FH22N
C1,C2	18 pF chip capacitor
C3	330 pF chip capacitor

The completed 1.9 GHz amplifier for this example with all components and SMA connectors assembled is shown in Figure 6.

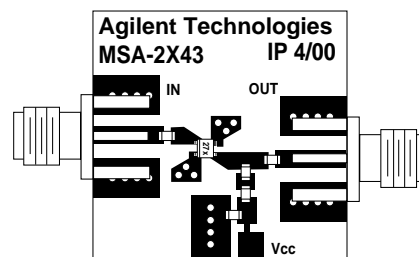

Figure 6. Complete 1.9 GHz Amplifier.

### Performance of MSA-2743 1.9 GHz Amplifier

The amplifier is biased at a Vcc of 5.25 volts, Id of 50 mA. The measured gain, noise figure, input and output return loss of the completed amplifier is shown in Figure 7. Noise figure is a nominal 4.0 to 4.1 dB from 1800 through 2000 MHz. Gain is a minimum of 15.1 dB from 1800 MHz through 2000 MHz. The amplifier output intercept point (OIP3) was measured at a nominal +28.5 dBm. P-1dB measured +15.0 dBm.

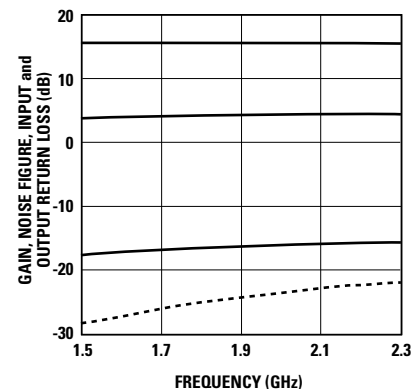

Figure 7. Gain, Noise Figure, Input and Output Return Loss Results.

### 900 MHz Design

The 900 MHz example follows the same design approach that was described in the previous 1900 MHz design. A schematic diagram of the complete 900 MHz circuit is shown in Figure 8. And the component part list is show in Table 3.

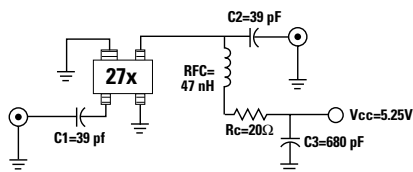

Figure 8. Schematic of 900 MHz Circuit.

Table 3. Component Parts List for the MSA-2743 Amplifier at 900 MHz.

R1	20Ω chip resistor
RFC	47 nH LL1608-FH47N
C1,C2	39 pF chip capacitor
C3	680 pF chip capacitor

### Performance of MSA-2743 900 MHz Amplifier

The amplifier is biased at a  $V_{cc}$  of 5.25 volts,  $I_d$  of 70 mA. The measured gain, noise figure, input and output return loss of the completed amplifier is shown in Figure 9. Noise figure is a nominal 3.8 to 4.0 dB from 800 through 1000 MHz. Gain is a minimum of 17.1 dB from 800 MHz through 1000 MHz. The input return loss at 900 MHz is 21.5 dB with a corresponding output return loss of 29.9 dB. The amplifier output intercept point (OIP3) was measured at a nominal +31.4 dBm.  $P_{-1dB}$  measured +18.5 dBm.

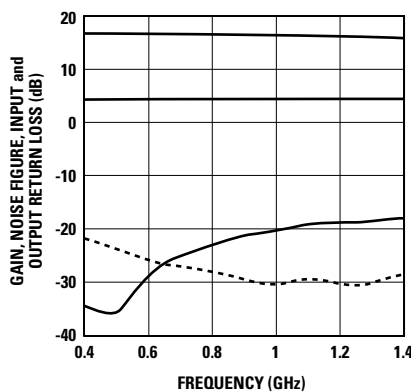

Figure 9. Gain, Noise Figure, Input and Output Return Loss Results.

### Designs for Other Frequencies

The same basic design approach described above for 1.9 GHz can be applied to other frequency bands. Inductor values for matching the input for low noise figure are shown in Table 4.

Table 4. Input and Output Inductor Values for Various Operating Frequencies.

Frequency	C1 & C2, pF	RFC, nH	C3, pF
400 MHz	88	100	1500
900 MHz	39	47	680
1900 MHz	18	22	330
2.4 GHz	15	18	270
3.5 GHz	18	15	22
5.8 GHz	1.8	6.8	10

Actual component values may differ slightly from those shown in Table 3 due to variations in circuit layout, grounding, and component parasitics. A CAD program such as Agilent Technologies' ADS® is recommended to fully analyze and account for these circuit variables.

### Notes on RF Grounding

The performance of the MSA series is sensitive to ground path inductance. Good grounding is critical when using the MSA-2743. The use of via holes or equivalent minimal path ground returns as close to the package edge as is practical is recommended to assure good RF grounding. Multiple vias are used on the evaluation board to reduce the inductance of the path to ground. The effects of the poor grounding may be observed as a “peaking” in the gain versus frequency response, an increase in input VSWR, or even as return gain at the input of the RFIC.

### A Final Note on Performance

Actual performance of the MSA RFIC mounted on the demonstration board may not exactly match data sheet specifications. The board material, passive components, and connectors all introduce losses and parasitics that may degrade device performance, especially at higher frequencies. Some variation in measured results is also to be expected as a result of the normal manufacturing distribution of products.

### Statistical Parameters

Several categories of parameters appear within this data sheet. Parameters may be described with values that are either “minimum or maximum,” “typical,” or “standard deviations.”

The values for parameters are based on comprehensive product characterization data, in which automated measurements are made on of a minimum of 500 parts taken from six non-consecutive process lots of semiconductor wafers. The data derived from product characterization tends to be normally distributed, e.g., fits the standard bell curve.

Parameters considered to be the most important to system performance are bounded by *minimum* or *maximum* values. For the MSA-2743, these parameters are: Gain ( $G_{test}$ ) and Device Voltage ( $V_d$ ). Each of the guaranteed parameters is 100% tested as part of the manufacturing process.

Values for most of the parameters in the table of Electrical Specifications that are described by *typical* data are the mathematical mean ( $\mu$ ), of the normal distribution taken from the characterization data. For parameters where measurements or mathematical averaging may not be practical, such as S-parameters or Noise Parameters and the performance curves, the data represents a nominal part taken from the center of the characterization distribution. Typical values are intended to be used as a basis for electrical design.

To assist designers in optimizing not only the immediate amplifier circuit using the MSA-2743, but to also evaluate and optimize trade-offs that affect a complete wireless system, the *standard deviation* ( $\sigma$ ) is provided for many of the Electrical Specifications parameters (at 25°C) in addition to the mean. The standard deviation is a measure of the variability about the mean. It will be recalled that a normal distribution is completely described by the mean and standard deviation.

Standard statistics tables or calculations provide the probability of a parameter falling between any two values, usually symmetrically located about the mean. Referring to Figure 10 for example, the probability of a parameter being between  $\pm 1\sigma$  is 68.3%; between  $\pm 2\sigma$  is 95.4%; and between  $\pm 3\sigma$  is 99.7%.

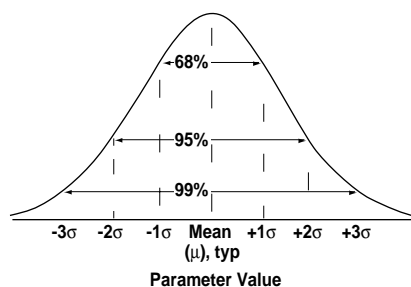

Figure 10. Normal Distribution.

### Phase Reference Planes

The positions of the reference planes used to specify S-parameters for the MSA-2743 are shown in Figure 11. As seen in the illustration, the reference planes are located at the point where the package leads contact the test circuit for the RF input and RF output/bias. As noted under the s-parameter table in section one of the data sheet the MSA-2743 was tested in a fixture that includes plated through holes through a 0.025" thickness printed circuit board. Due to the complexity of de-embedding these grounds, the S-parameters include the effects of the test fixture grounds. Therefore, when simulating the performance of the MSA-2743 the added ground path inductance should be taken into account. For example if you were designing an amplifier on 0.031" thickness printed circuit board material, only the difference in the printed circuit board thickness needs to be included in the simulation, i.e.  $0.031" - 0.025" = 0.006"$ .

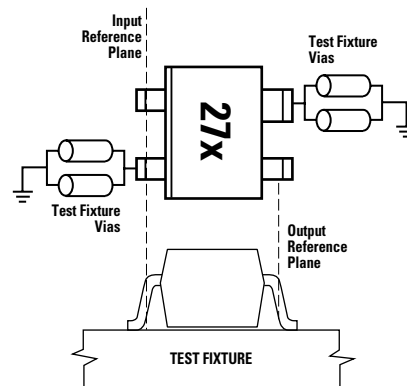

Figure 11. Phase Reference Planes.

### SMT Assembly

Reliable assembly of surface mount components is a complex process that involves many material, process, and equipment factors, including: method of heating (e.g., IR or vapor phase reflow, wave soldering, etc.) circuit board material, conductor thickness and pattern, type of solder alloy, and the thermal conductivity and thermal mass of components. Components with a low mass, such as the SOT-343 package, will reach solder reflow temperatures faster than those with a greater mass.

The MSA-2743 is qualified to the time-temperature profile shown in Figure 12. This profile is representative of an IR reflow type of surface mount assembly process. After ramping up from room temperature, the circuit board with components attached to it (held in place with solder paste) passes through one or more preheat zones. The preheat zones increase the temperature of the board and components to prevent thermal shock and begin evaporating solvents from the solder paste. The reflow zone briefly elevates the temperature sufficiently to produce a reflow of the solder. The rates of change of temperature for the ramp-up and cool-down zones are chosen to be low enough to not cause deformation

of the board or damage to components due to thermal shock. The maximum temperature in the reflow zone ( $T_{MAX}$ ) should not exceed 235°C.

These parameters are typical for a surface mount assembly process for the MSA-2743. As a general guideline, the circuit board and components should be exposed only to the minimum temperatures and times necessary to achieve a uniform reflow of solder.

### Electrostatic Sensitivity

RFICs are electrostatic discharge (ESD) sensitive devices. Although the MSA-2743 is robust in design, permanent damage may occur to these devices if they are subjected to high energy electrostatic discharges. Electrostatic charges as high as several thousand volts (which readily accumulate on the



human body and on test equipment) can discharge without detection and may result in degradation in performance, reliability, or failure.

Electronic devices may be subjected to ESD damage in any of the following areas:

- Storage & handling
- Inspection & testing
- Assembly
- In-circuit use

The MSA-2743 is a ESD Class 1 device. Therefore, proper ESD precautions are recommended when handling, inspecting, testing, assembling, and using these devices to avoid damage.

### References

Performance data for MSA series of amplifiers are found in the CD ROM Catalog or <http://www.agilent.com/view/rf>

### Application Notes

AN-S001: Basic MODAMP MMIC Circuit Techniques

AN-S002: MODAMP MMIC Nomenclature

AN-S003: Biasing MODAMP MMICs

AN-S011: Using Silicon MMIC Gain Blocks as Transimpedance Amplifiers

AN-S012: MagIC Low Noise Amplifiers

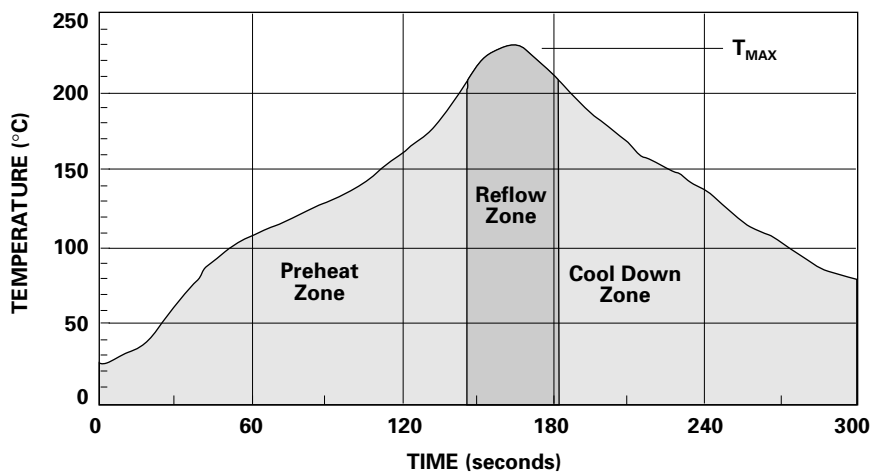

Figure 12. Surface Mount Assembly Profile.

### Ordering Information

Part Number	No. of Devices	Container
MSA-2743-TR1	3000	7" Reel
MSA-2743-TR2	10000	13" Reel
MSA-2743-BLK	100	antistatic bag

### Package Dimensions

#### Outline 43

#### SOT-343 (SC70 4-lead)

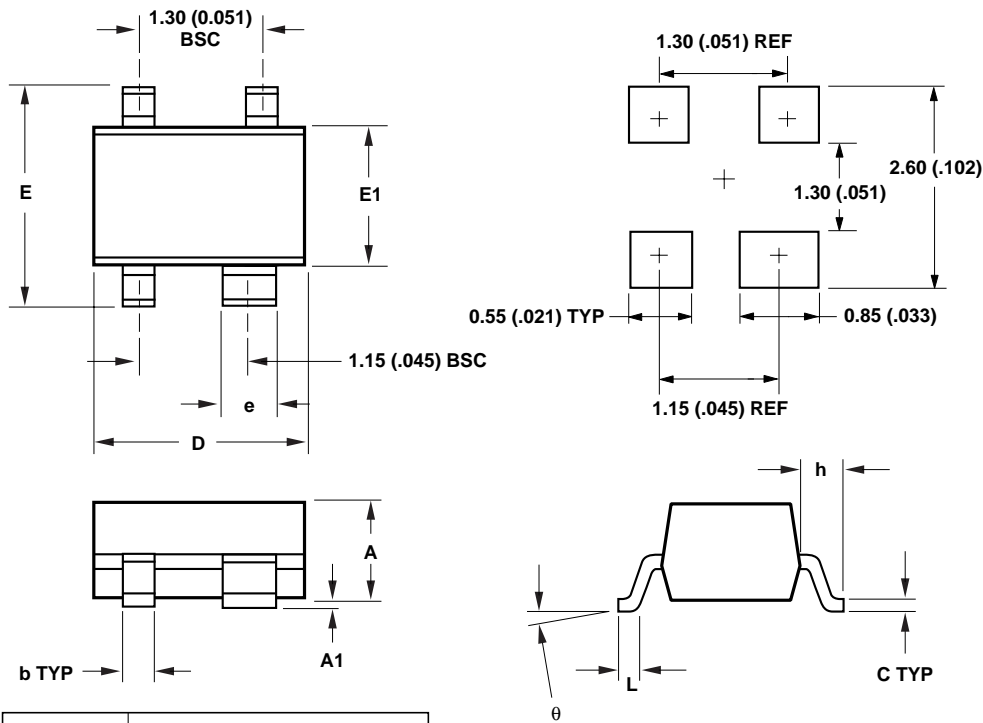

SYMBOL	DIMENSIONS	
	MIN.	MAX.
A	0.80 (0.031)	1.00 (0.039)
A1	0 (0)	0.10 (0.004)
b	0.25 (0.010)	0.35 (0.014)
C	0.10 (0.004)	0.20 (0.008)
D	1.90 (0.075)	2.10 (0.083)
E	2.00 (0.079)	2.20 (0.087)
e	0.55 (0.022)	0.65 (0.025)
h	0.450 TYP (0.018)	
E1	1.15 (0.045)	1.35 (0.053)
L	0.10 (0.004)	0.35 (0.014)
θ	0	10

DIMENSIONS ARE IN MILLIMETERS (INCHES)





## 当社半導体部品のご使用にあたって

### 仕様及び仕様書に関して

- ・本仕様は製品改善および技術改良等により予告なく変更する場合があります。ご使用の際には最新の仕様を問い合わせの上、用途のご確認をお願いいたします。
- ・本仕様記載内容を無断で転載または複写することは禁じられております。
- ・本仕様内でご紹介している応用例(アプリケーション)は当社製品がご使用できる代表的なものです。ご使用において第三者の知的財産権などの保証または実施権の許諾に対して問題が発生した場合、当社はその責任を負いかねます。
- ・仕様書はメーカーとユーザ間で交わされる製品に関する使用条件や誤使用防止事項を言及するものです。仕様書の条件外で保存、使用された場合に動作不良、機械不良が発生しても当社は責任を負いかねます。ただし、当社は納品後1年以内に当社の責任に帰すべき理由で、不良或いは故障が発生した場合、無償で製品を交換いたします。
- ・仕様書の製品が製造上および政策上の理由で満足できない場合には変更の権利を当社が有し、その交渉は当社の要求によりすみやかに行われることとさせていただきます。なお、基本的に変更は3ヶ月前、廃止は1年前にご連絡致しますが、例外もございますので予めご了承ください。

### ご使用用途に関して

- ・当社の製品は、一般的な電子機器(コンピュータ、OA機器、通信機器、AV機器、家電製品、アミューズメント機器、計測機器、一般産業機器など)の一部に組み込まれて使用されるものです。極めて高い信頼性と安全性が要求される用途(輸送機器、航空・宇宙機器、海底中継器、原子力制御システム、生命維持のための医療機器などの財産・環境もしくは生命に悪影響を及ぼす可能性を持つ用途)を意図し、設計も製造もされているものではありません。それゆえ、本製品の安全性、品質および性能に関しては、仕様書(又は、カタログ)に記載してあること以外は明示的にも黙示的にも一切の保証をするものではありません。

### 回路設計上のお願い

- ・当社は品質、信頼性の向上に努力しておりますが、一般的に半導体製品の誤動作や、故障の発生は避けられません。本製品の使用に附随し、或いはこれに関連する誤動作、故障、寿命により、他人の生命又は財産に被害や悪影響を及ぼし、或いは本製品を取り付けまたは使用した設備、施設または機械器具に故障が生じ一般公衆に被害を起こしても、当社はその内容、程度を問わず、一切の責任を負いかねます。  
お客様の責任において、装置の安全設計をお願いいたします。